

August 2024

# MARITIME REPORTER AND ENGINEERING NEWS

marinelink.com

Out with the Old, in with the New

## MS Amera Gets a New Lease on Life

Since 1939 | Number 8 | Volume 86

**HEAVY HAULER**

Andreas Rolner, MD, UHL

**MEET THE CTO**

Dr. Gunnar Stiesch, MAN ES

**SUBSEA CABLING**

A Growing Fleet

**BALLAST WATER TECH**

Getting the Numbers Right





Meet us  
in Hall A3  
Stand A3.301

**MAN Energy Solutions**  
Future in the making



# Moving big things to zero

**with future-proof  
retrofit solutions**

## **We're enabling long-term sustainability**

Balancing decarbonization, availability, and economics is a challenge for energy-intensive sectors like power generation, shipping, and process industries. Retrofits are one of the most effective ways to achieve net-zero targets. Our experts convert your conventional fuel engines into dual fuel systems that can also run on green e-fuels. By upgrading existing engines and turbomachinery, we balance ecology and economy, and give your business a long, clean future.

**survitec**  
SURVIVAL TECHNOLOGY

# SUIT X CHANGE

Immersion suit rental made easy. Keeping you on time, compliant and out of port without delay



**SCAN ME** to discover how you can swap your traditional immersion suit purchase and servicing model for a time-saving rental package





50

## 28 Subsea Cabling: A Growing Fleet

Analyzing the trends power the subsea cable fleet growth.

By Philip Lewis

## 34 Meet the CTO: Dr. Gunnar Stiesch, MAN ES

At the tip of the spear in decarbonization, Dr. Gunnar Stiesch walks us through the R&D process and discusses 'what's next in ship power.'

By Greg Trauthwein

## 41 MS Amera gets a new Lease on Life

Cruise ship is upgraded in Poland with Wabtec engines, Flender gears and Kongsberg propellers and thrusters.

By Greg Trauthwein

## 50 Interview: Andreas Rolner, MD, UHL

In business just 10 years, Andreas Rolner has built a powerhouse in the heavy lift ship sector.

By Greg Trauthwein

## 54 The Numbers Game

It was never going to be realistic to expect treated ballast water to get to zero.

By Wendy Laursen

Photo on the cover: Copyright Phoenix Reisen / BSM Cruise | Image courtesy UHL

## Departments

- 4 Authors & Contributors
- 5 Editorial
- 6 Training Tips for Ships
- 10 Back to the Drawing Board:
- 14 Ship Design
- 20 The Path to Zero
- 24 Inside the U.S. Coast Guard  
**R&D Center**
- 58 In the Engine Room:  
**Naval Gensets**
- 62 Shipyard in Focus:  
**EDR Antwerp Shipyard**
- 65 Tech Focus: **Clean Water**
- 67 Tech Focus: **Software**
- 70 New Products
- 72 In the Shipyard
- 74 The Final Word
- 77 Classifieds
- 76 Buyer's Directory
- 80 Advertisers Index





# partner

As you expand your capabilities in the marine market, you need a trusted partner to help you grow.

Regal Rexnord builds world-class marine solutions using some of the most respected brands in the industry. Our engineering and innovation excellence enables us to provide reliable and high-quality products for the most challenging propulsion and above deck applications.

Maximize your value with Regal Rexnord's one source for marine solutions.

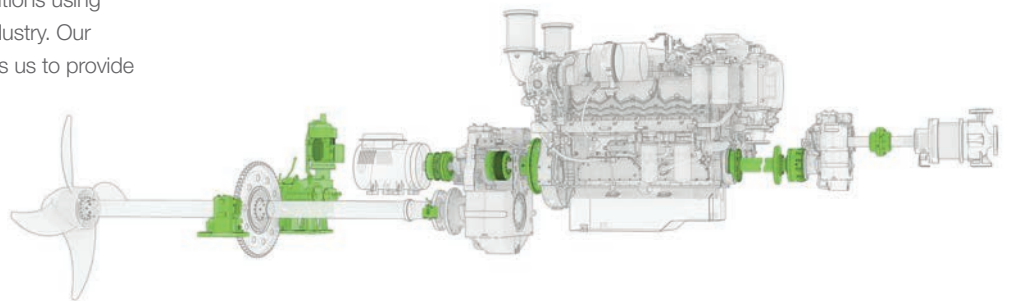

Learn more at  
[marine.regalrexnord.com](https://marine.regalrexnord.com)

**RegalRexnord™**  
Creating a Better Tomorrow

Ameridrives™ | Bauer Gear Motor™ | CENTA™ | Jaure™  
Stromag™ | Svendborg Brakes™ | Twiflex™ | Wichita Clutch™

Regal Rexnord, Ameridrives, Bauer Gear Motor, CENTA, Jaure, Stromag, Svendborg Brakes, Twiflex and Wichita Clutch are trademarks of Regal Rexnord Corporation or one of its affiliated companies.  
© 2024 Regal Rexnord Corporation, All Rights Reserved. | 1363



## Authors & Contributors



**Combs**



**DiRenzo**



**Guillory**



**Laursen**



**Lewis**



**Marshall**



**Macesker**



**Nikkanen**



**van Hemmen**

### Combs

Heather Combs is the newly appointed CEO of Ripple Operations and AdonisHR.

### DiRenzo

Dr. Joe DiRenzo is the Partnership Director at the USCG Research and Development Center. A career cutterman, he has also led the RDC's Science and Technology Innovation Center (STIC). Dr. DiRenzo is a graduate of the United States Naval Academy, Naval War College, and Marine Corps University.

### Guillory

Darren Guillory is the Technical Solutions Specialist at SSI USA.

### Laursen

Wendy Laursen has 20 years of

experience as a journalist. She has a Master of Science research degree in marine ecology as well as diplomas in journalism, communication and subediting.

### Lewis

Philip Lewis is Director Research at Intelatus Global Partners. He has market analysis and strategic planning experience in the energy and maritime sectors.

### Marshall

Steve Marshall is a business writer with long experience in maritime and offshore media, having worked for leading industry publications TradeWinds and Upstream, and now with media consultancy Blue-C.

### Macesker

Bert Macesker is the RDC's Executive Director and is responsible for all facets of center operation. He has served at the RDC for 30 years including stints as a Project Manager and Branch Chief. He is a graduate of Florida Atlantic University and University of Connecticut.

### Nikkanen

Mikko Nikkanen leads strategy and development for Vaisala's Maritime and Ports segment.

### van Hemmen

Rik van Hemmen is the President of Martin & Ottaway, a marine consulting firm that specializes in the resolution of technical, operational and financial issues.

# MARITIME REPORTER AND ENGINEERING NEWS

MARINELINK.COM

ISSN-0025-3448  
USPS-016-750  
No. 8 Vol. 86

Maritime Reporter/Engineering News (ISSN # 0025-3448) is published monthly except for March, July, and October by Maritime Activity Reports, Inc., 118 East 25th St., New York, NY 10010-1062. Periodicals Postage Paid at New York, NY and additional mailing offices.

### POSTMASTER:

Send all UAA to CFS. NON-POSTAL AND MILITARY FACILITIES send address corrections to Maritime Reporter, 850 Montauk Hwy., #867, Bayport, NY 11705.

The publisher assumes no responsibility for any misprints or claims or actions taken by advertisers. The publisher reserves the right to refuse any advertising. Contents of the publication either in whole or part may not be produced without the express permission of the publisher.

Copyright © 2024 Maritime Activity Reports, Inc.

### SUBSCRIPTION INFORMATION

#### In U.S.:

One full year (9 printed issues) \$90.00;  
Two years (18 printed issues) \$150.00

#### Rest of the World:

One full year (9 printed issues) \$140.00;  
two years \$180.00 (18 printed issues) including postage and handling.

### CONTACT INFORMATION:

Email: [mrcirc@marinelink.com](mailto:mrcirc@marinelink.com)  
Web: [www.marinelink.com](http://www.marinelink.com)  
t: (212) 477-6700  
f: (212) 254-6271



Business Publications Audit of Circulation, Inc.



# EverClean

The always clean performance solution

Save fuel

Reduce carbon emissions

Minimize downtime

Maintain biosecurity

Improve performance

Find us at SMM in the  
US Pavilion B7.224  
to learn more about robotics for  
hull inspection and cleaning.



**Greensea IQ**  
Intelligent Ocean Solutions





MARINELINK.COM

**HQ**  
118 E. 25th St., 2nd Floor  
New York, NY 10010 USA  
T +1.212.477.6700

**CEO**  
John C. O'Malley  
jomalley@marinelink.com

**President & COO  
Publisher & Editor**  
Greg Trauthwein  
trauthwein@marinelink.com

**Editor - MarineNews**  
Eric Haun  
haun@marinelink.com

**Offshore Energy Editor**  
Amir Garanovic  
garanovic@offshore-engineer.com

**Production Manager**  
Irina Vasilets  
vasilets@marinelink.com

**Production & Graphic Design**  
Nicole Ventimiglia  
nicole@marinelink.com

**Corporate Staff  
Manager, Marketing**  
Mark O'Malley  
momalley@marinelink.com

**Accounting**  
Esther Rothenberger  
rothenberger@marinelink.com  
+1.212.477.6700 ext 6810

**Manager, Information Technology Services**  
Vladimir Bibik

**Circulation**  
Kathleen Hickey | k.hickey@marinelink.com  
+1.212.477.6700 ext 6320

**Sales  
Vice President, Sales**  
Terry Breese  
breese@marinelink.com | +1.561.732.1185

Lucia Annunziata  
annunziata@marinelink.com  
+1.212.477.6700 ext 6240

John Cagni  
cagni@marinelink.com | +1.631.472.2715

Frank Covella  
covella@marinelink.com | +1.561.732.1659

Mike Kozlowski  
kozlowski@marinelink.com | +1.561.733.2477

Gary Lewis  
lewis@marinelink.com | +1.516.441.7258

**International Sales  
Scandinavia & Germany**  
Roland Persson, Orm Marketing AB, Box 184,  
S-271 24, Ystad, Sweden  
roland@orn.nu; +46 411 184 00

**Founder:**  
John J. O'Malley [1905 - 1980]  
Charles P. O'Malley [1928 - 2000]  
John E. O'Malley [1930 - 2019]



Photo Justin Zurro

Similar, I'll assume, to most everyone reading these pages, there are parts of my job that I love, there are parts of my job that I'd be happy to flush away and never see again. [But I guess that since I've just passed the 32-year mark at *Maritime Reporter & Engineering News*, the latter outweighs the former!] A favorite part is traveling the world, visiting shipyards and large manufacturing plants, meeting people on their turf, where they live to learn more about their history, their business, their future.

One notable recent visit was last month to Beloit, Wisconsin, to visit the **Fairbanks Morse Defense (FMD)** engine manufacturing plant. I know that it's impossible to be everywhere, but following several hours with my gracious hosts at FMD, I was sorry to say I'd never made the time to visit this gem about an hour plus outside of Chicago, a company with a 175-year history that transcends marine engines and equipment. Giving a twist to a familiar car commercial motto, "*this is not your father's Oldsmobile*", the FMD of today is certainly not the Fairbanks Morse that most of you know. There is much more to come on this visit, but a sincere bit of thanks to **Pat Bussie** and **Keith Haasl**, a pair of long-tenured FMD executives that collectively have a knowledge and a passion for the maritime business and their business that is infectious.

This edition is the 'SMM' edition, with bonus copies to the SMM shipbuilding and ship machinery exhibition in Hamburg, Germany. SMM is the pinnacle of maritime exhibitions, a display on the size, scale and influence and that is difficult to replicate. If you've never been you're truly missing out on the biggest, best display of maritime technology and collection of leading industry executives globally.

With that, the story on the refit of the MS

Amera was perfect for this month's cover, with this ship's original old engines coming out the side and, if you turn to page 44, you'll see the new high power, low emission **Wabtec** engines in the engine room; designed to power the vessel for a generation to come. While I did not see this ship project up close and personal while it was

**If you will be in Hamburg for SMM, visit *Maritime Reporter & Engineering News* in Hall A3, booth A3.228. If you're planning to launch a new product or service, ping me via email below my signature, as we'll have our professional video crew in for the exhibition for exclusive in-booth interviews.**

transformed at the **Remontowa Shipyard** in Gdansk, Poland, a huge 'thank you' goes to **Tim Mass**, Technical Superintendent, **BSM Cruise**, who was responsible to see the project through, and who shared excellent insights on the decisions that were made along the way.

Immediately following, starting on page 50, is the story of **United Heavy Lift (UHL)** – a global heavy cargo lift powerhouse that runs one of the youngest, largest fleets in the sector. On the eve of taking delivery the latest F900 Ecolifter – UHL's 19th identical ship – **Andreas Rolner**, Managing Director, UHL, shared with us insights on the strategy to grow the company, admitting a new design is almost complete for the next generation of heavy lift ships, a design that could end up in shipyard's hands for bidding later this year ... pending market and finance conditions.

**Gregory R. Trauthwein**  
Publisher & Editor  
trauthwein@marinelink.com





Copyright Phoenix Reisen / BSM Cruise

**Undocking of MS Amera in Gdansk. Turn to page 40.**



**The New Wave of Energy-Efficient Technologies**

Our simple, reliable ballast water management systems protect the environment while using far less power than competitor systems—meaning they can also help reduce your fuel consumption and emissions.

Plus, through our innovative environmental technology affiliates we are able to provide shipowners with a full suite of “green marine” options. These energy-efficient technologies enable you to meet regulatory goals quickly and cut operating costs, all while delivering exceptional performance and reliability.



Visit us at SMM to discuss a tailored solution to suit your needs: **SMM Exhibition Stand—Hall 1 Stand 218**

*Choose Ecochlor. Choose Peace of Mind.*

sales@ecochlor.com ♦ www.ecochlor.com



EcoOne® Ballast Water Management System



Passive Air Lubrication System



Scrubber • Carbon Capture & Storage



Gas-freeing Tank Technology



## Tip #61

# Prep Mariners through Training: Adapting to New OSHA Regulations on Sun Exposure and Breaks

Copyright songwut/AdobeStock

Federal workplace safety officials have announced the first-ever national heat stress rule aimed at protecting workers from heat-related illnesses and fatalities. The proposed regulations from the Occupational Safety and Health Administration (OSHA), unveiled on July 2nd, 2024, emphasize the need for maritime training programs to adapt and prepare workers for these changes. While OSHA's authority is primarily limited to shoreside facilities such as shipyards and repair docks, these guidelines offer valuable insights for improved onboard training. Given that many maritime organizations operate shipyards, scalable training should include mariners. Additionally, the United States Coast Guard and international authorities may introduce similar regulations for onboard operations in the future. Beyond mere compliance, training mariners improves their safety and prepares the crew to handle heat-related emergencies, benefiting passengers as well.

Organizations like cruise lines, which operate in multiple nations, must conform to numerous regulatory regimes, often with overlapping requirements. An organized approach is needed to address multiple standards through a unified training effort.

### Understanding the New Heat Stress Regulations

The new rules aim to enhance worker safety by mandating regular breaks, providing protective gear, and ensuring proper hydration. OSHA has stated that "heat is the leading cause of weather-related deaths in the United States," underscoring the importance of these measures. Notably, the proposed standard would apply to all employers conducting outdoor and indoor work in all general industry, construction, maritime, and agricultural sectors where OSHA has jurisdiction.

### Key Components of the Proposed Heat Stress Regulations

Mandating that crew members take regular breaks in shaded or cool areas is a key component of the new regulation. These breaks help ensure that mariners do not suffer from heat exhaustion or more severe heat-related illnesses. Informing mariners about the benefits of wearing UV-protective clothing, hats, and sunglasses is important. Showing how to properly use and care for sun protection gear, including applying sunscreen,

helps reduce the risk of sunburn and long-term skin damage.

Highlighting the need for frequent hydration helps combat dehydration. Guidelines on water intake frequency and quantity, especially in hot conditions, should be included in training programs to help mariners stay hydrated. Proper hydration practices are also essential for passenger safety. Teaching mariners to recognize the signs and symptoms of heat stress and related illnesses enables early intervention. Learning first aid procedures and immediate response actions can save lives. Crew members should learn to monitor temperature and humidity levels and adjust work schedules and activities based on fluctuating environmental conditions.

### Enhancing Training Programs for Heat Safety

Regular heat safety drills prepare mariners to respond effectively to heat stress situations. These drills should simulate real-life scenarios and include practice of emergency procedures to prepare mariners for heat-related emergencies. Behavioral training should emphasize self-monitoring and peer-monitoring for signs of heat stress. Teaching mariners to look out for each other and report symptoms immediately fosters a supportive and vigilant work environment.

Informing mariners about the role of nutrition in maintaining hydration and heat tolerance enhances their overall health and ability to cope with heat stress. Providing information on foods and drinks that help keep the body cool and hydrated can improve mariners' ability to handle heat stress.

### Emergency Planning and Response

Creating and implementing a written Heat Injury and Illness Prevention Plan (HIIPP) helps evaluate and control heat hazards. This plan should include site-specific information to evaluate and control heat hazards and must be made available to each employee in a language they understand. Training supervisors and workers to respond effectively to heat-related emergencies ensures timely and proper care for those affected. This includes providing first aid and contacting emergency services promptly, ensuring that all souls onboard receive the necessary care quickly.



## Recordkeeping and Reporting

Keeping written or electronic records of indoor monitoring data for at least six months ensures compliance and allows for review. These records help track conditions and ensure that any necessary adjustments can be made to improve safety. Detailed records of heat-related incidents, including illnesses and near-misses, help review and improve safety practices. This data can be used to review and improve heat safety practices. Regular audits of heat safety measures and compliance with emerging standards help identify areas for improvement. These audits ensure ongoing adherence to regulations and promote continuous improvement in heat safety practices.

## Cultural Competence in Heat Safety

Creating training materials in multiple languages accommodates a diverse crew. Using visual aids, such as vessel specific videos, enhances understanding and retention of heat safety information across different cultural backgrounds. Having experienced mariners lead training sessions and share their insights and practical tips on handling heat stress provides valuable, relatable learning experiences. Workshops that

allow mariners to discuss and role-play heat stress scenarios provide a deeper understanding through hands-on experience.

## Conclusion

Training mariners to handle the challenges posed by extreme heat is an ongoing effort. By integrating comprehensive heat safety training into your regular programs, you not only comply with potential regulations but also contribute to a safer and more resilient maritime industry. Fostering a culture of continuous learning and improvement will be key to ensuring the well-being of your crew and the safety of your passengers.

Thank you for reading, and until next time, sail safely.

### The Author

## Combs

Heather Combs is the newly appointed CEO of Ripple Operations and AdonisHR.



IMO Tier III and EPA Tier 4 certified.  
No SCR. No urea. No soot on deck.

## Simply Clean

Wabtec's medium speed marine diesel engines are certified to IMO Tier III and EPA Tier 4 emissions standards **without** requiring SCR and urea-based exhaust after-treatment.

- **Proven technology** - since 2016 over 1,200 engines in service with over 1 million running hours on marine engines
- **Easier and less expensive** to install
- Eliminates spacious provisions required for a SCR after-treatment system and urea storage, **preserving valuable accommodation, cargo and tank space**
- **Simple to operate** and **no additional operating expenses** from urea use, catalyst replacements and SCR component maintenance
- Developing **low/no carbon** fuel ready platform
- Improved **CII/EECI** with low fuel consumption and increased heat recovery.

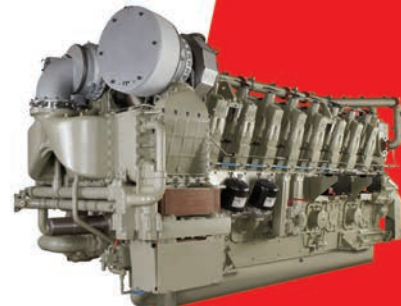

3-6 sept 2024  
leading international  
maritime trade fair  
www.hamburg.com



Booth #A4.200

**No urea. No kidding.**

MSDProducts@wabtec.com  
wabteccorp.com/marine-solutions



# 50 Years of Air, Water and Wild Life Quality Improvements

*By Rik van Hemmen*

**I**moved to the United States in 1976. It was an interesting time because the United States had recently enacted laws that were intended to improve the country's air, water, and wild life.

Instead of specific archaic environmental laws that, for example, outlawed dumping dead horses into the Hudson River, these were nationwide laws that set a minimum national standard that was to be enforced by the newly created EPA.

These laws were enacted during the Nixon administration even though some of these laws were vetoed by Nixon and had to be overridden by a congressional super majority.

I suppose these laws were passed by Congress because it was patently clear to both Democrats and Republicans that things were not the way they were supposed to be. Many animal species had disappeared, rivers were burning and air pollution was so bad it was literally killing people. I am not fully familiar with the debates during the creation of those laws, but I am sure there were factions that were predicting total economic collapse if those laws were enacted and, in general, there was strong corporate resistance based on the fear profits would decrease when corporations were forced to reduce pollution and clean up the mess they had made in the past.

I am almost certain that these laws negatively affected profits of corpora-

tions that had caused the damage to the environment, but I very much doubt that the overall economy was negatively affected by these laws, because the reduced profits actually paid for new industries that were involved in reducing and remedying pollution. Those businesses did not really exist prior to the environmental laws and now were providing good incomes for a significant part of the population. It should be remembered that the quality of an economy is most strongly related to employment and it makes no difference if that employment is related to creating pollution or cleaning up pollution.

Most of all, there is no reason to feel sorry for any person or business that made

a mess of things the moment they are required to clean up the mess they made.

What is often ignored in the environmental debates is that the lowest hanging fruit is a drive to greater technological efficiencies, which reduces costs for everybody. And once things start to improve, everybody's health and quality of life is improved with a cleaner environment. When those trends are combined it becomes clear environmental protection and pollution remediation is a killer app. It does not happen overnight, but, looking back over the past 50 years, the results are nothing but astonishing. Everybody truly lives better today than 50 years ago. Not just the rich; everybody has a higher quality of

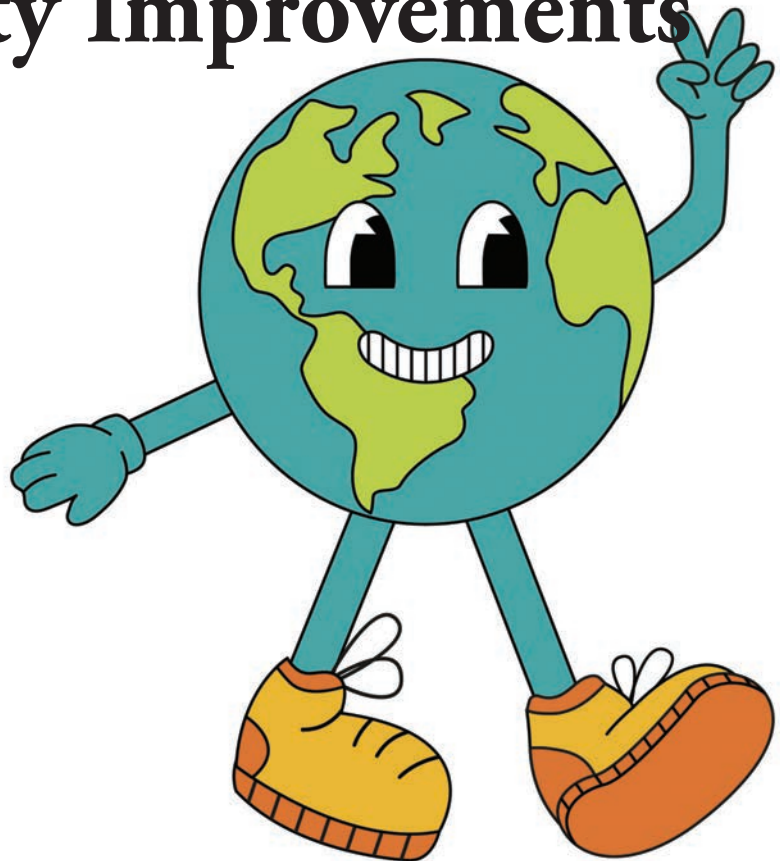

Graphic above: Copyright Yulia/AdobeStock



life. Even in underserved communities where a lot remains to be done, the results are still positive.

Quantifying the results is difficult, but the results are all around us. Our rivers and our coast, overall, are much cleaner. There have been marked improvements in species recovery (even though, unfortunately, it can also be described as a significantly reduced rate of extinction). While we are challenged with achieving zero carbon, overall, our air quality is much better.

I have not been able to find a quantitative analysis of water quality, since it is difficult to cast all the minor and major local improvement into a single nationwide whole. One exception to this is OPA 90 and its IMO derivatives. There the result is nothing short of astonishing, but it is only a small part of overall water quality management. The one thing that can be measured and quantified is national air quality and the EPA

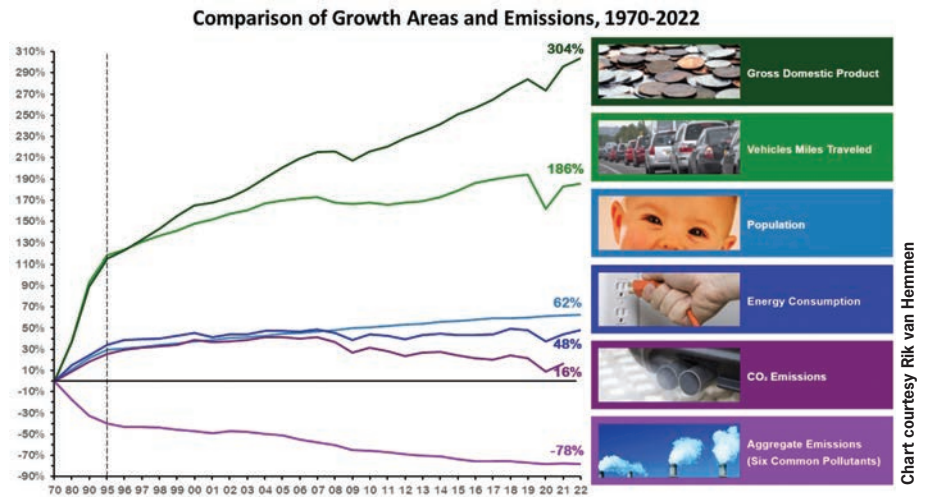

Chart courtesy Rik van Hemmen

provides an annual report on it called "EPA Air Quality – National Survey".

These annual reports come with a graphic that is called the Baby Graphic and it is copied for this article.

It is a great graphic but first I need to point out that it contains an annoying distortion. At first glance it may appear

that there were much more dramatic changes from 1970 to 1995, but that is related to the compressed X axis scale for that period. After 1995, changes are recorded year by year, while before 1995 the same interval covers five years. For better perspective I properly expanded the scale, and drew in straight

**TRUST-OCEAN**  
by Chris-Marine

**Automated Vessel Performance**  
**Automated DCS & MRV reporting**  
**Automated Compliance**

**Automated Savings**

Meet our experts at  
**SMM 2024**  
and learn more!  
Hall A3. Stand 402.

**SMM**

**CHRIS-MARINE**

[www.chris-marine.com](http://www.chris-marine.com)



## Back to the Drawing Board

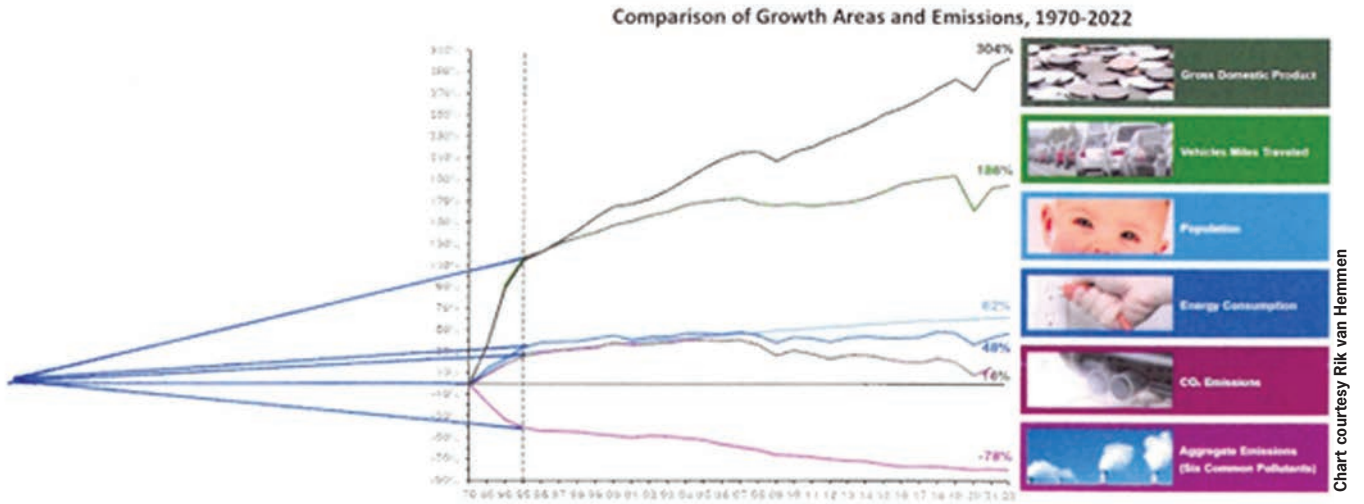

lines for the 1970 to 1995 interval. It then shows all overall trends are pretty steady until 2008 except GDP growth, which appears to have increased in the more recent 27 years.

2008 is where things become inter-

esting. (See chart above).

At that point the trends start to change. Keep in mind we are looking at 2008, the year of the Great Crash. That was a dramatic historical moment of great economic upheaval, but, from

an environmental point of view, things changed for the better. This is the point in time when the population continues to grow at a very steady pace. (Yes, the present immigration concerns are not a population growth issue.), but the GDP

**YouTube**

**MARITIME REPORTER TV**

The Maritime Industry's Most Popular News and Insights Channel



**Maritime Reporter TV**  
Over 660,000 Views

**SUBSCRIBE TODAY!**





grows much faster, so we are all getting richer. At the same time, energy consumption goes flat and CO2 emissions starts to drop. In effect, since 2008 the trends are going where we want them to go. There was a drop during COVID, but, overall, the trends are steady. There is a subtle flattening of the air improvement curve, but that is probably a temporary effect due to technical limits with regard to fossil fuel combustion. Once we electrify everything there will be a second wave of air quality improvements.

At this stage it is unclear if energy consumption will continue to decrease against GDP, but as long as we continue to phase out fossil fuels that is not an immediate concern. (It may an issue once fossil fuels have been phased out, because too much cheap energy turns us all into inefficient energy hogs).

The really fun part of this graph is that it actually gives us a glimpse into the future. If we continue to convert to zero carbon, there will be less air pollution and there will be less carbon, a win win at no cost to the economy in general. And the faster we do it, the more everybody benefits.

The day after I wrote the first draft of this column, I came across a new DNV report named "Energy Transition Outlook, New Power Systems" that supports these trends and, in addition, notes that the cost of energy per capita will actually go down once fossil fuels have been phased out. This is a big deal, since the cost of energy per capita is one of the most significant indicators

of general wealth.

It is so easy to think the world is going to pot, but compared to the 1970's the important trends have never been this good! Nobody said it would be easy, but there is a bright light shining at the end of the tunnel.

**References:**

- <https://www.epa.gov/air-trends/air-quality-national-summary>
- <https://brandcentral.dnv.com/original/gallery/10651/files/original/f5149884-79ab-4a3e-99f2-10e59e36db79.pdf>

**OmniTHRUSTER™**  
Marine Maneuvering and Propulsion Systems

**UNCOMPROMISED CONTROL**

JT Series

HT Series

- Low Submergence Requirement
- Small Hull Penetrations
- Auxiliary Propulsion/ "Take Home" Capability
- Effective Thrust in Currents
- Proudly Made in the USA! 

**Waterjet Bow/Stern Thrusters  
Up to 2,200HP**

**2201 Pinnacle Parkway • Twinsburg, OH 44087  
(330) 963-6310 www.omnithruster.com**

For each column I write, **Maritime Reporter & Engineering News** has agreed to make a small donation to an organization of my choice. For this column I nominate New Jersey Friends of Clearwater, [www.njclearwater.org](http://www.njclearwater.org). A small group of peaceful environmental warriors that remembers how bad it was in 1970.



# The Brain-Drain Conundrum

*By Darren Guillory, Technical Solutions Specialist, SSI*

**H**ow do you balance the fact that your skilled workforce will get older and retire and leave you with a group of younger individuals that will not have the “experience” that your more tenured employees have? Back in the day individuals would not pass down knowledge to younger workers in fear of being replaced. The days of reckoning are upon us. An older workforce is leaving with years of knowledge bottled up in their heads with no way to capture the information. What is the solution? Can brain-drain be mitigated?

Here is an example of brain-drain that every older individual can relate to. As a young man I learned to drive in

a vehicle that had a standard transmission. The hard jolt of not shifting correctly is burned in my memory. The moment you cause a stall and must restart the car while other drivers glare at you in traffic. You learn quickly how to smoothly shift from one gear to the next just so this doesn't happen to you again. Now imagine a 15-year-old, or for that matter a 20-year-old today getting into a car with a standard transmission. Their mind would be blown away with the little gearshift and the extra peddle down by the break. That is just a simple example of brain-drain. No one taught them because the technology of cars meant that we didn't need standard transmissions any longer. Now imagine an entire



workforce of an industry with no experience or knowledge being passed on to them. This is the brain-drain conundrum! No other workforce in the construction industry is affected more by this conundrum than “Shipbuilding”.

Shipbuilding has been around for centuries, and it has gone through its cycles of innovation and improvement, but the basic tenants of shipbuilding stay consistent. That is until now. U.S. Shipbuilding is facing a two-fold attack. An ageing and retiring workforce paired with an ever-increasing demand for technological innovation. Once upon a time a shipbuilder could work his entire career in one place and retire while knowing he could have his own kids working in that same place for their entire career. Coupled with the instability of industry workloads and the ever-increased competition for those workload contracts, there has been an attrition to the industry. Some smaller yards that were once stable places of employment for community workforces have gone under. Either due to competition and lack of work or simply due to the lack of a

replacement workforce with the knowledge to continue competing in the industry. The ever-present brain-drain.

This brain-drain is, simply put, an Aging Workforce with no replacement system to depend on. For example, the average age of maritime and shipyard workers is around 41-55 years old. These workers are closer to retirement than the start of a career. This is tied to the fact that most high school aged kids are pressured to attend college and not enter the physical labor workforce has led to the difficulty of the modern shipyard to find replacement workers. This also leads them to face a hard reality, either adapting to the ever-changing world or falling by the wayside. So, what can be done to mitigate the brain-drain conundrum? Several factors must be realized first before you can address the problem.

- Accessing what your shipyard workforce looks like. Is it a group of aging individuals who will walk out the door with the years of insight and knowledge that can hurt you



**CIMOLAI Technology spa**  
Special Equipment

info@cimolai.tech  
www.cimolaithechnology.com



**Mobile Boat Hoists**



**Ship Lifting Platforms “Cimolift”**



**Portal Cranes**



**Transfer Systems**





going forward?

- Do you have a viable pipeline of talent coming through your doors? Compete effectively to attract and retain talent.

- Do you promote from within, and do you promote industry pride? A workforce that is proud of what they do is probably the best recruiting tool any industry has. It fosters community pride in their towns and cities and gets locals to want to stay and work for them.

- Do you have collaborations with industry associations and government agencies? Most shipyards are the local economic “blood line”, work in the shipyard fosters work in the communities in which they reside. These symbiotic relationships can build industry partnerships that gather interest for individuals to come to those areas and build their lives around the work.

- Do you have ways to automate and modernize? Investing in modernization and automation can be one of the biggest ways to mitigate “brain-drain” but also it can foster interest in new workforces to come to work for you. A cutting-edge company is very desirable to a young and upcoming workforce.

- Do you have retention strategies in place to keep workers? Nothing hurts a shipyard more than talented workers walking out the door. Developing a retention strategy should be fundamental. This could be apprenticeship programs to foster internal growth and development of the younger workers in your yard.

- Identify workers or candidates that will stay for the long haul. Look for candidates that are aligned with company values and goals.

- Clear paths to advancement are a talent magnet. Candidates who know they can advance with a company are more likely to stay with a company.

- Show your workforce that they are appreciated and recognize their achievements. Recognition goes a long way to fostering a workforce that wants to continue to grow.

- Provide your teams with ongoing learning opportunities. Skill workshops, career paths, mentorship programs. These are tied to the advancement portions that will keep skilled employees.

- Competitive compensation packages and benefits.

---

**MARITIME MATTERS:**  
**THE MARINELINK**  
**PODCAST**

Join our hosts as they take you on a riveting voyage, filled with captivating stories, cutting-edge trends, and thought-provoking discussions. Whether you're an industry professional, a maritime enthusiast, or simply curious, this podcast is tailor-made for you.

Available on YouTube

Listen on Spotify

Listen on Apple Podcasts



Money will always be a big attraction to employees, but added benefits such as insurances and education opportunities can really retain a workforce.

These are just a few mitigation strategies that a company can implement to stop the brain-drain conundrum. We as an industry owe it to ourselves as well as the workforces we currently employ, to seek out new ways and strategies to keep and retain talent. If we don't, the competitive advantage will shift to Shipbuilders in other markets. Local smaller shipyards and companies will be left with little choice but to outsource or downsize. Which is just another way of saying "slowly dying off". Over the years the attrition to shipbuilding has been seen top to bottom with companies absorbing smaller entities or smaller yards just shutting the doors.

Although brain-drain is not limited to shipbuilding it may have a greater effect on this industry because of its inherent history. Comparatively, the construction industry is not beholden to a specifically trained workforce and can easily retain a dedicated workforce. While shipbuilders are a niche

within the construction industry and are more specialized. Which is why the brain-drain conundrum affects them more. Gone are the days of the "family line" workforce that constantly replenish shipyard workers.

Even with all the mitigation efforts companies can take to retain talented workers, it will come down to a company really getting to know its workforce and understanding what makes them want to stay or want to leave. Companies that recognize they are suffering from brain-drain can put mitigation plans in place and address retention problems. Until then the "Brain-Drain Conundrum" could be with us for a while.

**The Author**

**Guillory**

Darren Guillory is the Technical Solutions Specialist at SSI USA. Prior to joining the SSI team he spent nearly two decades in the commercial shipbuilding industry (LE-EVAC Shipyards).



**Serving Western  
Alaska and the  
Pacific Northwest**



**JOIN OUR TEAM @ [RESOLVEMARINE.COM/CAREERS](https://RESOLVEMARINE.COM/CAREERS)**

**Shipyard Services & Drydock • Marine Construction  
Commercial Diving • Marine Services**

**Dutch Harbor, Alaska +1.907.581.1400**

**Tacoma, Washington +1.253.302.4323**



**ResolveMarine.com**

## EverClean

The always clean performance solution

Save fuel • Reduce carbon • Minimize downtime • Maintain biosecurity • Improve performance



# Revolutionizing Hull Maintenance for a Sustainable Maritime Future

EverClean delivers solutions as the maritime industry is starting to face the long-standing challenge of biofouling and its impact on a ship's performance.

Biofouling is the accumulation of microorganisms, plants, algae, or small animals on submerged hull surfaces that significantly increase fuel consumption and carbon emissions. According to the IMO, even a thin layer of slime about 0.5 mm thick covering half the hull can increase emissions by up to 20%. Making it clear that addressing biofouling effectively and frequently can play a major role in lowering carbon emissions in shipping.

Greensea IQ's EverClean service is leading this transformation, by offering a proactive approach to hull maintenance. EverClean employs advanced robotics, replacing the traditional, reactive cleaning methods with regular, gentle in-water cleaning meant to keep hulls "always clean," ensuring optimal hydrodynamic performance and significantly reducing fuel consumption and emissions on the ship regardless of the coating or the fuel being used.

### EverClean: A Proactive Solution

EverClean's method to optimize efficiency through improved hydrodynamics meets the needs of an industry aiming to drastically cut emissions. Regular maintenance through EverClean prevents the accumulation of biofouling, by the continuous removal of biofouling EverClean service ensures vessels operate efficiently, leading to substantial fuel savings and a reduction in greenhouse gas emissions.

### Why Proactive Cleaning Matters:

- **Early Intervention:** Microfouling, if not addressed early, can escalate to macrofouling, increasing emissions and fuel usage. Addressing biofouling at its earliest stages prevents the significant performance penalties associated with macrofouling.
- **Environmental Compliance:** Regular cleaning ensures vessels meet stringent biofouling management requirements, such as those recently enacted in Australia. Compliance with these regulations is increasingly important as global environmental standards become stricter.

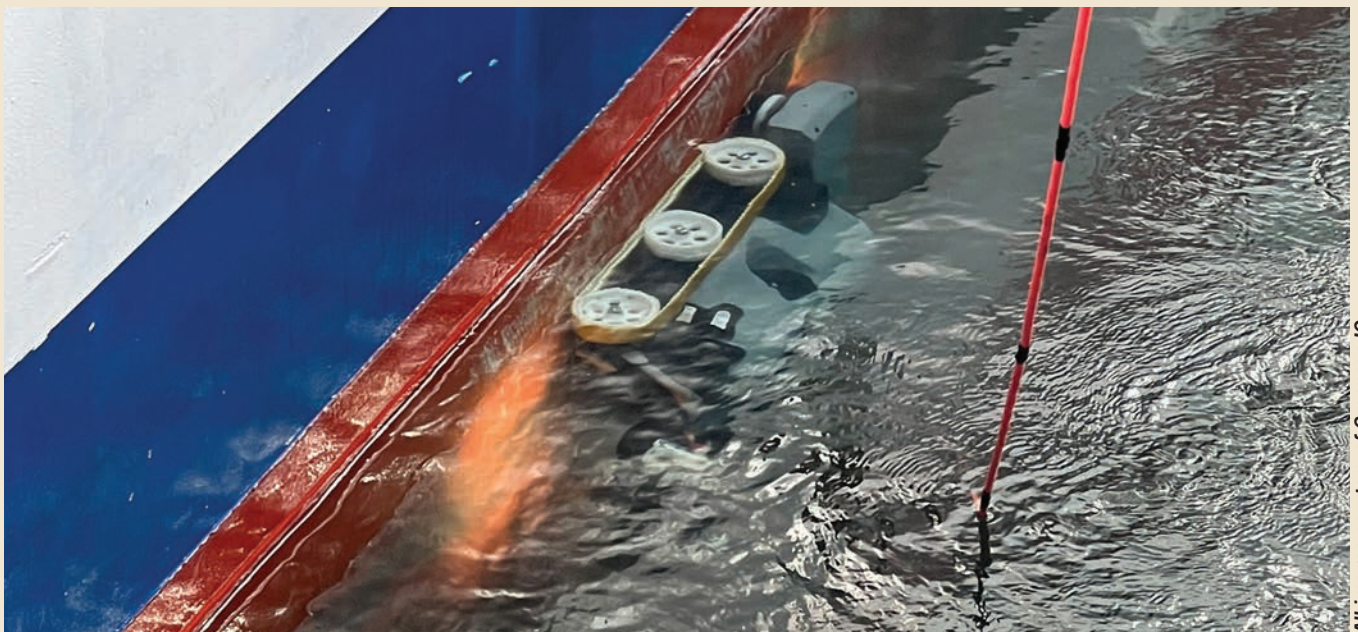

All images courtesy of Greensea IQ



### Key Benefits of EverClean:

- **Enhanced Performance:** Regular proactive cleaning leads to a 15% reduction in fuel consumption and emissions, translating to significant savings and environmental benefits. This reduction is achieved by maintaining a clean hull, which minimizes drag and maximizes fuel efficiency.
- **Safe for Coatings:** Proven safe for various hull coatings, including silicone-based ones, ensuring no damage while maintaining effectiveness. This aspect is crucial as it extends the life of the coatings, reducing the frequency and cost of reapplications.
- **Efficient Operations:** The EverClean robots' small size and autonomy reduce deployment costs and operational disruptions, making it feasible to clean hulls frequently without damaging the coating. This efficiency is crucial for maintaining regular cleaning schedules without interrupting vessel operations.
- **Expanding Coverage:** Growing presence in both US and international ports and resident on ship options, with new locations added monthly to meet global demand. This expansion means that more vessels can benefit from the EverClean service, contributing to a broader environmental impact.

### EverClean IQ: Intelligent Insights for Informed Decisions

EverClean IQ elevates the EverClean service by leveraging data from each cleaning session to provide detailed reports on hull status, coating conditions, and biofouling levels. This intelligence enables shipowners and operators to make informed maintenance decisions, enhancing overall vessel performance.

### Features of EverClean IQ:

- **Detailed Reporting:** Comprehensive data on fouling rates, coatings performance, corrosion, and hull deformation. This level of detail helps in planning maintenance and avoiding unexpected issues that could disrupt operations.
- **Advanced Monitoring:** Continuous video and positional data collection, offering precise, georeferenced insights into hull conditions. This real-time monitoring capability ensures that shipowners are always aware of their hull's condition, leading to timely interventions and maintenance.

By integrating advanced robotics with intelligent data analysis, EverClean IQ provides a comprehensive solution that not only cleans but also monitors and reports on the hull's condition. This proactive approach is essential for maintaining optimal performance and achieving environmental goals.

### Join the Revolution in Maritime Sustainability

The integration of advanced robotic cleaning, detailed digital reporting, and precise performance metrics marks a new



era in hull maintenance. Greensea IQ is now scaling our service to provide the maritime industry with innovative tools that enhance vessel performance, reduce emissions, and promote sustainability.

By embracing these proactive solutions, the maritime industry can achieve significant cost savings, meet ambitious decarbonization targets, and ensure a cleaner, greener future for our oceans.

Innovations such as EverClean are transforming the way the maritime industry approaches hull maintenance. These solutions provide comprehensive, proactive cleaning and monitoring capabilities that ensure vessels remain efficient and environmentally compliant. As the industry moves towards more sustainable practices, these technologies will play a crucial role in reducing emissions and protecting our oceans.

Adopting these innovative solutions not only benefits the environment but also provides substantial financial savings for vessel owners and operators. The reduction in fuel consumption and maintenance costs, combined with improved vessel performance, makes a compelling case for the widespread adoption of EverClean.

Join us in revolutionizing hull maintenance and paving the way for a sustainable maritime future. With proactive cleaning and intelligent monitoring, we can achieve significant environmental and economic benefit.

### The Author

## Howard

Rob Howard is Chief Growth Officer for Greensea IQ and has been championing the benefits of maintaining an always clean hull since the launch of EverClean in 2021.

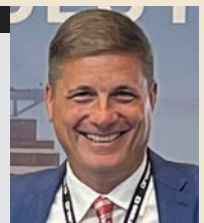

MARIN conducted performance tests on Canopée - a WASP vessel using four OceanWings sails - with Vaisala WindCube Nacelle lidar.



Photo courtesy of MARIN

# Fueling the Future of Sustainable Shipping with Wind-Assisted Vessels

*By Mikko Nikkanen, Head of Maritime, Weather and Environment, Vaisala*

**D**ecarbonizing the maritime shipping sector is imperative in tackling climate change and limiting global temperatures to 1.5 degrees Celsius above preindustrial levels. Despite increasing pressure to reduce its carbon footprint while maintaining operational efficiency, international shipping emissions increased to a record high in 2022.

As the world grapples with the urgent need to address climate change, the global shipping industry — responsible for approximately 3% of global greenhouse gas emissions — demands innovative solutions to chart a course toward sustainability. Among the most promising advancements is wind-

assisted ship propulsion — or WASP — which blends ancient sailing techniques with cutting-edge engineering.

Today's wind-assisted vessels are not the sailing ships of old but rather sophisticated machines that use rigid sails, rotors or wing-like structures to supplement traditional engine power and propel vessels, reducing carbon emissions and the industry's reliance on fossil fuels.

Regulatory changes and technological advancements are driving rapid adoption, but the success of wind-assisted shipping hinges on a critical factor: the ability to accurately measure and harness wind power in real time.



**BAR Technologies uses  
Vaisala WINDCAP®  
Ultrasonic Wind Sensor  
WMT700s in their  
WindWings installations.**



Photo courtesy of BAR Technologies

### **The Challenge of Accurate Wind Measurement**

While the concept of wind propulsion is straightforward, its practical implementation remains anything but. WASP systems depend on precise and reliable wind data, which is used to optimize the deployment of wind-assist technologies. Consequently, the key to maximizing thrust from wind-assisted propulsion is accurate, real-time wind data.

While traditional wind measurements for navigation allow for course corrections, wind-assisted propulsion demands far greater precision. Inaccurate wind data for navigation might lead to minor route adjustments, but for WASP, it means irretrievably lost energy. Every gust not optimally harnessed is propulsion power permanently forfeited, underscoring the critical need for highly accurate, real-time wind measurements. It's the difference between just steering a vessel and maximizing its clean energy potential with every nautical mile.

However, obtaining reliable wind measurements on a moving vessel presents unique challenges: Traditional cup anemometers — long the standard for wind measurement at sea — are no longer sufficient for the demands of modern wind-assisted shipping. Sensors can be blocked or masked, or the ship's own superstructures can create wind turbulence and distort readings. With cup anemometers alone, wind speed measurements can experience a 50% to 60% variance if they are not correctly situated on the vessel.

Also, placing anemometers on the ship can result in read-

ings that reflect local wind effects rather than the broader wind conditions affecting the entire vessel. Such localized data is less useful for optimizing WASP system performance.

These factors can lead to inaccurate wind data, potentially compromising wind propulsion system performance. Alternative methods, such as ultrasonic anemometers and wind lidars, are being explored to address these challenges.

### **Technologies Advancing WASP Potential**

Addressing and overcoming the limitations of traditional anemometers prepares the maritime industry to harness wind power efficiently and effectively.

Ultrasonic anemometers use sound waves to measure wind speed and direction, offering higher accuracy and reliability than their mechanical counterparts. They also have no moving parts, making them more durable in harsh marine environments. By adding multiple ultrasonic anemometers on different sides of the vessel, operators can secure the constant flow and the quality of the wind data. Installing multiple sensors in various locations — the bow, bridge and stern — avoids total blockage situations. This approach ensures a constant flow of quality wind data, even if one or more sensors are affected by the ship's superstructure.

Perhaps the most groundbreaking development in maritime wind measurement is the application of lidar — light detection and ranging — technology. Wind lidars use laser beams to measure wind speed and direction at multiple distances from the

ship, providing a comprehensive picture of the wind field around the vessel.

Once a vessel is equipped with the WASP system, performance validation depends on undisturbed raw wind data. Enter wind lidar for the ship's sea trial. Equipping the vessel with wind lidar in-

strument empowers operators to continuously measure the real winds outside of the vessel, undisturbed by the ship's superstructures, and compare that data to the ultrasonic anemometer-provided data. Afterwards, they can make the correlation and further develop the optimi-

zation algorithms of the WASP system and continue with max thrust gained.

Lidar technology has been successfully used in the wind turbine industry to correct power performance, and its application in maritime shipping is now rapidly evolving.

Lidar technology offers several advantages:

- **Measurement of undisturbed wind:** Lidars can measure wind conditions remotely, hundreds of meters away and beyond the influence of the ship's structure, providing reliably accurate data.

- **Vertical profiling:** These instruments can measure wind at different heights, revealing the wind shear profile crucial for optimal sail positioning.

- **Wide-area scanning:** Some lidar systems can scan a large area around the ship, multiple kilometers away, offering a comprehensive view of the wind field.

Wind lidars can help optimize the performance of WASP systems by providing accurate and reliable wind measurements, contributing to greater fuel savings and reduced emissions.

### WASP Sea Trials

As mentioned, advanced wind measurement technology plays a crucial role in validating and optimizing the performance of wind propulsion systems.

The Maritime Research Institute Netherlands (MARIN) executes predictive work (such as CFD simulations and model testing) and uses the Vaisala WindCube suite in real-world testing of wind-assist propulsion vessels. One notable project is testing the ship *Canopée*, which integrates a WindCube Nacelle to acquire undisturbed wind data in front of the boat. Collected while crossing the Atlantic Ocean, this robust lidar data helps build trust in the predicted savings from wind propulsion and encourages investment and adoption by ship owners.

BAR Technologies is another key



Vaisala WINDCAP  
Ultrasonic Wind Sensor  
WMT700s and WindCube  
Nacelle lidar installed on  
Canopée vessel.

Photo courtesy of Vaisala



player in the wind-assisted shipping industry, with its WindWings technology for wind propulsion and route optimization. WindWings uses large, rigid sails to capture wind energy and provide additional thrust to the ship. The company uses three methods for predicting or analyzing fuel savings at sea:

- Comparing performance with wings up versus folded down.
- Using equivalent segments and digital twin modeling.
- Direct measurement of wing thrust using strain gauges.

Accurate wind data is essential for all these methods, allowing companies to fine-tune their systems and provide verifiable performance data to clients. This validation, in turn, builds confidence in WASP system technology and accelerates its adoption across the maritime sector.

### Realizing the Future of Green Shipping

Wind-assisted ships are here to stay. As the technology continues to evolve, we can expect to see improved integration, advanced weather routing and even the integration of artificial intelligence and machine learning to fine-tune system performance.

The maritime industry's journey toward sustainability is being propelled by the winds of change — literally and figuratively. WASP, backed by advanced wind measurement and monitoring technologies, offers a viable path to significantly reduce the sector's carbon footprint.

With companies like Vaisala, MARIN, and BAR Technologies leading the way in developing and implementing advanced wind measurement and wind-based propulsion solutions, the maritime sector is well positioned to navigate modern shipping challenges. Continuing to invest in and develop these technologies will empower the maritime industry to achieve significant fuel savings and emissions reductions, propelling the way to a greener future.

### The Author

## Nikkanen

Mikko Nikkanen leads strategy and development for Vaisala's Maritime and Ports segment. He has established Vaisala's maritime focus in modern weather awareness solutions.



## PRECISION SOLUTIONS REDEFINED

Testing & Analysis

Alignment

Machinery Services

Product Solutions

AME is a mechanical services company specializing in predictive, preventative, and corrective maintenance for machinery assets on land and sea. Condition monitoring using cutting-edge technology, methods, and procedures is the backbone of the support AME provides. Others make claims of their abilities, but AME has the backing of the American Bureau of Shipping/ABS as a recognized external specialist for condition monitoring and 30 years under their belt achieving successful solutions.

**AMESOLUTIONS.COM**  
Vibration & Alignment Specialists

**Providing Results Worldwide Since 1992**

# Inside the Coast Guard R&D Center



# *A Partner in the Service's Efforts to Thwart Narcotics and Human Smugglers*

*By Dr. Joe DiRenzo & Bert Macesker*

In 2011 the 210-foot Coast Guard Cutter VIGILANT was on patrol in the Caribbean when it came upon a suspected maritime narcotics smuggler. As the chase ensued, the suspected smuggler jettisoned bales of what turned out to be cocaine. The VIGILANT crew marked the position on their radar and gathered the latitude and longitude for the bales, then went in pursuit of the suspect vessel. After the suspect was apprehended, the VIGILANT returned to the original position in search of the bales, eventually finding one. At that time, it was standard practice to use paper plates to help track jettisoned contraband. The requirement to track and retrieve bales, which serve as evidence, is a critical part of the interdiction process.

Following that mission, the cutter's crew sent a message to both USCG Atlantic Area and the Coast Guard Research and Development Center (RDC) asking for research to be conducted regarding development of a mobile tracking system that could be jettisoned and inexpensively serve as a moving beacon for the bales. The RDC took on the challenge and developed multiple prototypes of the Maritime Object Tracking Technology or MOTT. This included drift studies to determine tracking object characteristics like bale drift parameters.

Over the next few years, the RDC developed prototypes and deployed them to major cutters in the Atlantic and Pacific. Sometime after completing early prototype evaluations as part

of a research project in 2014, one innovation adapted the electronics found in GPS-tracking hunting dog collars with a small floating buoy printed on RDC's 3-D printer. Following that early prototype effort, the RDC Science and Technology Innovation Center (STIC) partnered with the Naval Air Warfare Center to develop a custom-designed Automatic Identification System (AIS) marker buoy. Twenty MOTTs, a MOTT User's Manual, and a MOTT Technical Design Package were produced. The RDC did all of that while continuing to work with

operational Coast Guard units to evaluate the operational use.

For example, in the Spring of 2020, U.S. Southern Command began enhanced counter narcotics operations in the Western Hemisphere to disrupt the flow of drugs. The RDC took this opportunity to help operational commanders by packaging promising technologies into easy-to-use Go-Kits and shipping them to cutters at the speed of need. (See picture of MOTTs next to the picture of a Coast Guard canine equipped with RDC protective technology.) Included

Steadfast  
**QUALITY**  
Unmatched  
**SERVICE**

Navigate into  
the future with  
**The Marshall  
Islands Registry**

CELEBRATING  
**20**  
CONSECUTIVE YEARS  
2000-2024

hamburg@register-iri.com  
www.register-iri.com

The advertisement features a large image of a cargo ship's deck filled with colorful shipping containers. To the right of the ship, there is a blue and white graphic with the text 'Steadfast QUALITY Unmatched SERVICE'. Below this, it says 'Navigate into the future with The Marshall Islands Registry'. At the bottom right, there is a circular logo celebrating '20 CONSECUTIVE YEARS 2000-2024' and a QR code with the contact information 'hamburg@register-iri.com' and 'www.register-iri.com'. The Marshall Islands flag is also visible in the top right corner of the graphic area.

in these kits were MOTTs and Human Language Translators (HLTs) along with a low cost remotely operated vehicle, narcotics detection device, x-ray backscatter, firearms trainer, and imaging systems. Both the MOTTs and HLTs were successfully employed by the crews.

The MOTT and HLT were then transferred to the Department of Homeland Security (DHS) Science and Technology (S&T) Silicon Valley Innovation Program (SVIP) to get the MOTT and HLT to private industry for production. SVIP invests in startup companies for prototyping projects to adapt capabilities that are commercially sustainable while meeting the needs of DHS operational components. Both the MOTT and HLT are technologies that will be great tools for the operational Coast Guard and had their start with RDC.

The RDC receives an appropriation from Congress of \$7.5 million to support the execution of research for the entire Coast Guard. The limited resources are applied deliberately to priority research projects and support of commercial and government-off-the-shelf (COTS/GOTS) technology evaluations.

The discipline of research is important to the service in building toward new strategic capabilities. For RDC, these discipline ingredients include adherence to scientific integrity; human subject research protocols; solid experimental design; risk-based project management; adherence to environmental and privacy protection policies; and compliance with the many enterprise authorities to test and evaluate on Coast Guard systems and assets. These disciplines apply to RDC research projects that are typically longer-term and potentially transformative --- projects like the Next Generation Aids to Navigation (ATON), VHF Data Exchange System (VDES) --- essentially the next generation of AIS, and recent adoption of Starlink/Starshield communications aboard Coast Guard cutters. However, Coast Guard operators want technology rapidly to enhance mission performance today and to counter bad actors that have access to the same innovation ecosystem. With its limited resources, RDC does both strategic research and evaluations of high technology readiness COTS/GOTS technologies. These efforts are often mutually complimentary.

Time horizons for a typical RDC research project may be several years before it is fully transitioned to Program Office ownership. It stands to reason that high readiness COTS/GOTS technologies should have a shorter path to operations, especially if unit funding is available for mission performance tools.

RDC thought that there was a near-term win for operators when RDC completed the MOTT and the HLT evaluations. DHS S&T SVIP stepped in to assist with these two efforts. RDC completed the MOTT and HLT projects in 2017 and 2019. They are currently in the final phase under SVIP transition. SVIP funded business partners to develop HLTs with cur-

rent plans to have units ready for operational testing in 2026. A benefit of SVIP is that items that are ultimately developed can be procured under the sole source process. There will be many useful applications for an HLT in the Coast Guard and probably the most challenging is to provision boarding teams with a universal translator that works at the speed of natural language in disconnected environments. While RDC recommended, at the time, not to use devices evaluated in some tactical interactions because of its translation time delay, COTS/GOTS technology advanced quickly with existing solutions that could be immediately deployed while longer-term and more sophisticated solutions were developed.

The MOTT is but one of many examples of a long history of engagement in technologies and research that enhance the capabilities of Coast Guard units and their parent commands in detecting, disrupting, discovering, and interdicting human and narcotics smuggling operations. Each of the RDC's projects have contributed to Coast Guard mission success. Examples of the type of research that originated at RDC to help thwart smuggling:

- **Non-lethal stopping capability** – including the use of pepper balls, various unambiguous warning technologies, engine disabling capabilities, and various entanglement systems.

- **Derelict abandoned vessel marking** – so that air and surface assets identify vessels that have been previously checked so precious response resources are not expended more than once for the same vessel.

- **Small Unmanned Aircraft Systems (sUAS)** – extensive testing of sensors and capabilities including detect and avoid technology to enable sUAS surveillance beyond line-of-sight on Coast Guard cutters – especially for those without helicopter flight decks.

New efforts include testing of body worn cameras in support of future requirements and efforts that engage both public and private sectors in helping the Coast Guard think differently. An example includes an upcoming deterrence-focused EVERGREEN event that aims to formally define deterrence and offer Coast Guard ways to embrace and employ it across mission areas, including counter drug, and migrant patrol planning. (The purpose of EVERGREEN is to provide the Coast Guard with the essential tools, knowledge, and insights to act effectively despite much greater uncertainty about the future. The process is not designed to supersede or diminish the tradition of rapid response and tactical flexibility that has been the hallmark of the Coast Guard.)

In addition, the RDC has the Coast Guard's only optionally crewed and uncrewed small boats. One of these craft is a converted 29-foot Response Boat Small (RBS) that was deployed to the southwest border. Equipped with an array of sensors, the platform provided force multiplying capability linking with air, surface, and shoreside assets. The flexibility that this



platform provided was significant to the hosting Coast Guard Sector and Station.

The RDC, located in New London CT, has 82 staff members, and consistently delivers impactful products designed to support the operational and tactical components in completion of their mission. In fiscal year 2023, the RDC completed 16 research projects and delivered 69 products to the Coast Guard. A great deal of the RDC portfolio focuses on strategic research but understanding the operational advantages and efficiencies of existing and emergent technology will always be a focus. A particular challenge is to find ways to energize the faster adoption of lower investment technology solutions to equip operators at the speed of need. RDC is fortunate to have lab partners in DoD like U.S. Army Combat Capabilities Development Command, Air Force Research Laboratory, and Office of Naval Research, and in DHS like National Urban Security Technology Laboratory and Customs and Border Protection that value research but also the need to put high readiness technology into the hands of the Nation's warfighters and first responders as quickly as possible. RDC also turns to the private sector to help the Coast Guard with awareness of emergent technology and direct partnering of technology investigations.

If you are interested in working with this small, dedicated team in support of Coast Guard missions, watch for future RDC requests for information and cooperative research and development agreement opportunities posted on [SAM.gov](https://www.sam.gov), [Federal Register.gov](https://www.federalregister.gov) or [HSWERX.org](https://www.hswerx.org), respectively. The Commandant of the Coast Guard **Admiral Linda Fagan** says, "Tomorrow looks different ... so should we." The Coast Guard RDC lives this every day with a significant focus on stopping illegal maritime smuggling.

#### The Author

### DiRenzo

Dr. Joe DiRenzo is the Partnership Director at the USCG Research and Development Center. A career cutterman, he has also led the RDC's Science and Technology Innovation Center (STIC).



#### The Author

### Macesker

Bert Macesker is the RDC's Executive Director and is responsible for all facets of center operation. He has served at the RDC for 30 years including stints as a Project Manager and Branch Chief.



## RELIABILITY WHEN IT COUNTS

The pounding, corrosive seawater and tight machinery space make these applications unique and challenging, and a perfect match for Carver pumps. We've been building heavy-duty marine pumps for decades and are a recognized leader in the industry for seawater and other marine-duty services.

At Carver Pump, we do more than make pumps. We solve problems before they develop.



LEARN MORE AT  
[carverpump.com](https://www.carverpump.com)



**YOUR SHIP DOESN'T HAVE TO BE THAT LOUD!**

ASK US ABOUT OUR NOISE AND  
VIBRATION REDUCTION SYSTEMS.



**SCHIEDEL**

[WWW.E4POWERLLC.COM](https://www.E4POWERLLC.COM)

754-715-0818



# SUBSEA CABLING: A GROWING FLEET

***The subsea cable segment has become an increasingly important technology for the energy transition. The international cable layer segment, excluding fiber optic and telecommunications layers, is witnessing an increase in newbuilding activity, with some seven large and ultra large cable layers due for delivery in 2025-2027. This article analyses the trends in this segment.***

*By Philip Lewis, Director of Research, Intelatus Global Partners*



The following chart presents the international fleet of cable lay barges (CLB - generally for near shore/shallow water cable lay) and cable lay vessels (CLV). The chart excludes ~30 cable layers that are operating in the ring-fenced Chinese market and domestic (mainly) CLBs operating in Taiwan, Japan, South Korea and the USA. The remaining 50 or so vessels are effectively global. Driven by increasing offshore wind activity, the deployment of bigger turbines with larger wind turbines, and wind farms being built further offshore is driving the investment in larger cable layers.

In terms of offshore wind cable layers, this article will focus on four main groups of subsea cables, inter-array, export, oil & gas electrification, and interconnectors.

**INTER-ARRAY CABLES: BOTTOM-FIXED PROJECTS**

Array and collector cables create loops or individual strings of turbines that are generally connected to an offshore substation. Originally medium voltage alternating current (MVAC) cables of 33kV, the development of larger turbine output has driven an increase in inter-array cable, from 33kV to 66kV high voltage AC (HVAC) cables today. The next evolution in array cable manufacture is the 132kV, capable of supporting larger turbines (beyond 15 MW).

HVAC cables are three-phase cables that are generally manufactured and laid as a bundle in a three-core formation. In this configuration, each phase is a metallic conductor core, such as aluminum. As such, the bundle contains three insulated conductors (three “wires”) surrounded by an outer cor-

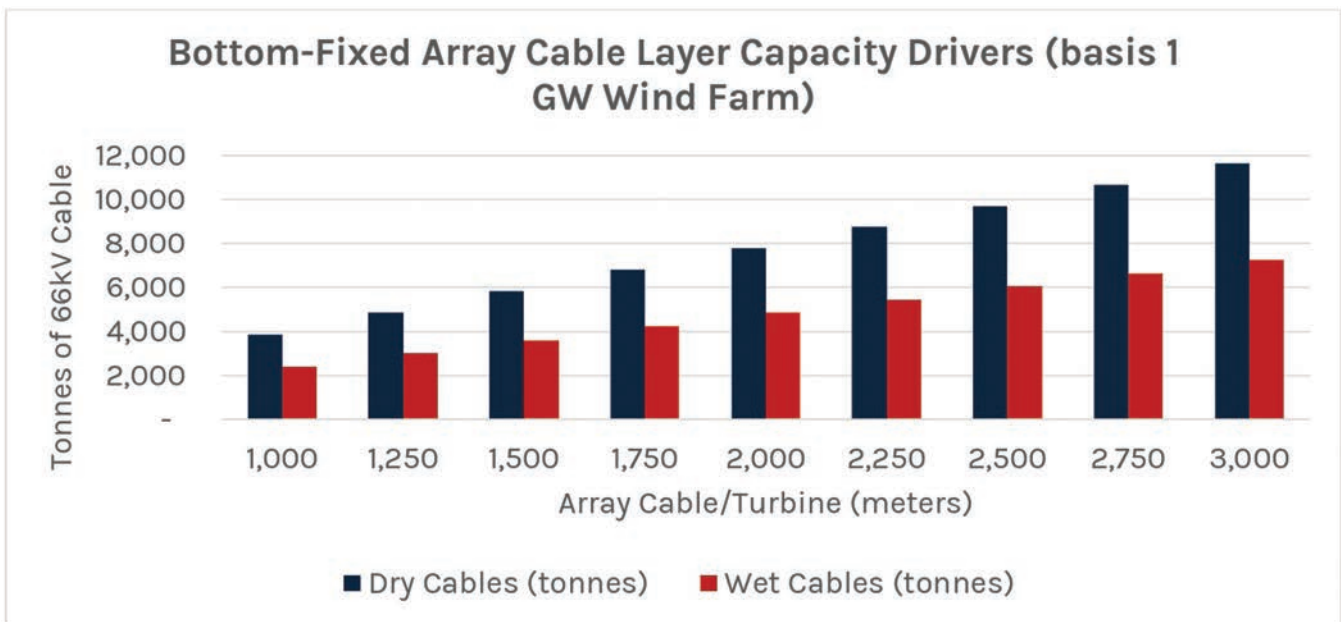
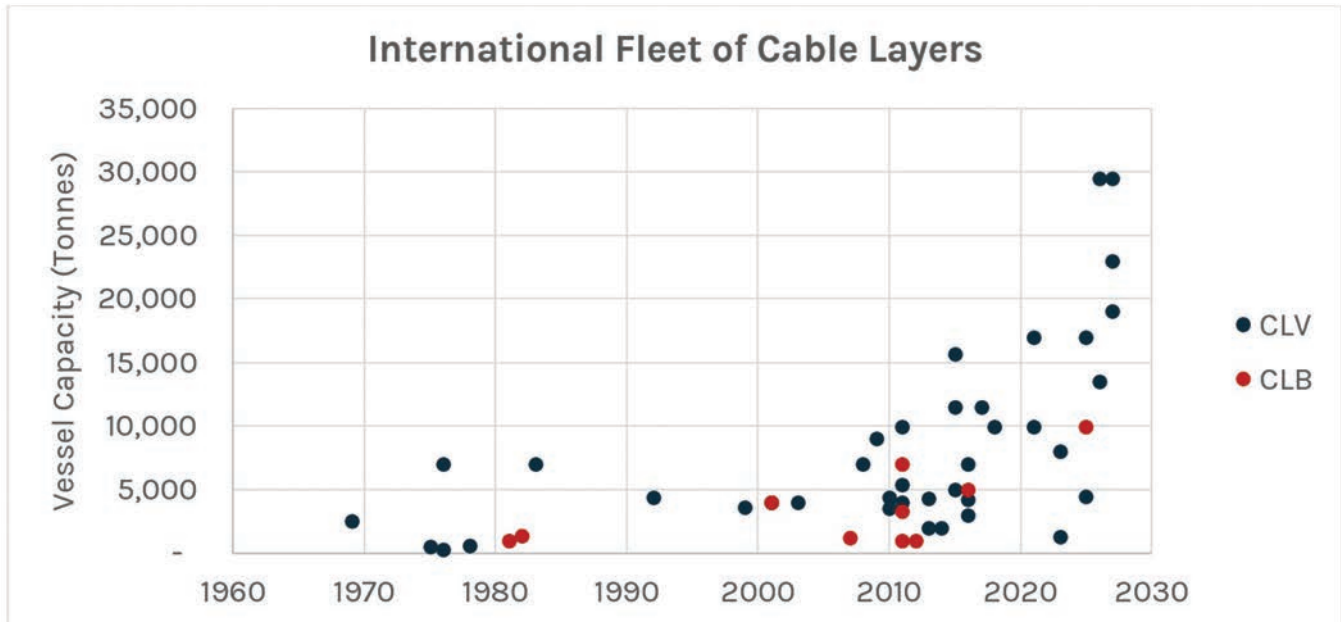

All charts courtesy Intelatus Global Partners

## SUBSEA CABLING

rosion protection sleeve.

Array cables are generally laid by cable lay vessels (CLVs) equipped to accommodate up to ±10,000 tonnes of cable.

The following chart demonstrates the foundation for the deployment of larger array cable layers of ~5,000-10,000 tonnes cable capacity. The chart examines the impact of key variables for a 66 kV inter-array cable system, linking 14-15 MW wind turbines on a 1 GW wind farm - the spacing between turbines/ amount of array cable per turbine (driven by specific country planning factors, site conditions, turbines, etc.) and the cable design, either the heavier traditional dry design cables or the lighter and more flexible wet design systems.

### FLOATING WIND ARRAY CABLE LAYERS

Floating wind is an emerging market that will develop at scale towards the end of this decade. A key difference in floating wind projects compared to traditional bottom-wind projects is the design of the cable. In a bottom-fixed wind farm, the array cable is referred to as a static cable as it is generally placed on the seabed and laid by a horizontal laying system.

A floating wind farm features dynamic cables, which may or may not sit on the seabed depending on site water depths and requires buoyancy aids to support the cable once laid. It is anticipated that floating wind turbines will largely be connected by 66-132kV HVAC wet design array cables. Dynamic cables are suited to the vertical lay systems seen in the oil & gas subsea vessel fleet. We expect that array cable lay installation for floating wind to rely on subsea vessels with AHC cranes of 250-400 tonnes, given that we anticipate the current fleet of CLVs to be fully occupied on bottom-fixed wind and

interconnector projects.

Globally there are ~75 subsea vessels with 250-400 tonnes AHC cranes. Please note that the vessels shown as being delivered in 2000 were delivered earlier but are shown as 2000 for convenience.

### EXPORT CABLES

There are two main offshore transmission system models:

- Radial transmission, where the wind farm owner builds a range from medium voltage (MV) to high voltage (HV) and extra high voltage (EHV) AC or DC transmission systems from the wind farm to connect to an onshore grid connection and networked grids. AC systems have been a common feature in radial transmission markets like the UK, China, some European countries and the USA. Till now, radial export systems have generally featured 33kV, 66kV, 132kV, and 220kV, although China has deployed several 500kV EHVAC systems. However, as wind farms become larger and are located further offshore, we anticipate that there will be an increase in HVDC radial export cable laying, especially in China, the UK and the USA.

- Centralized or networked grids popular in many European markets, where we see large networked offshore substations or substations located on offshore manmade energy islands collecting electricity from one or multiple wind farms and transmission power to the onshore network, originally though AC systems and increasingly through high capacity HVDC cable systems.

Most AC systems deployed till now are below 80 kilometers in length to minimize transmission losses. As noted previously,

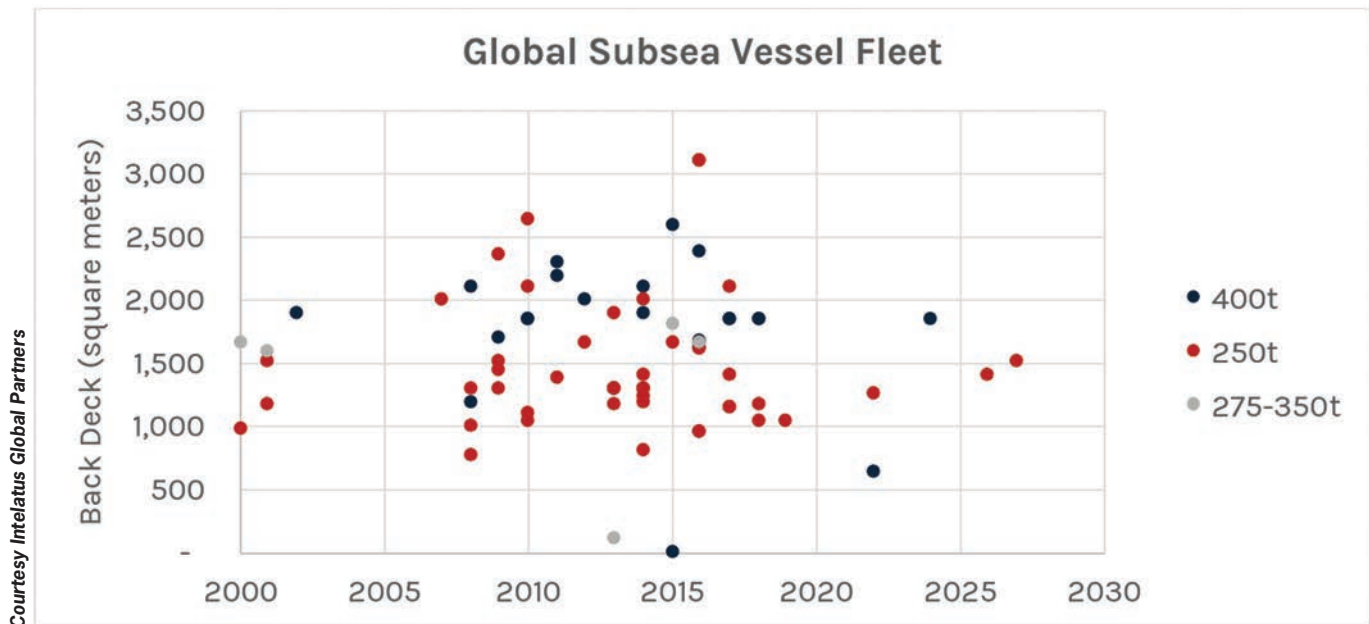

\* We can note from the chart above that limited newbuilding is currently ongoing. We expect more orders for new vessels to be placed given that these vessels are in high demand for oil & gas, and bottom-fixed wind cable lay and repair work.



## A GROWING FLEET

AC cables are three-phase cables that are generally manufactured and laid as a bundle in a three-core formation. Windfarms that deploy HVAC transmission systems usually transmit electricity over multiple circuits connecting to several offshore substations, with a maximum of ~400 MW per substation/export cable. Based on a review of European offshore wind farms (which drive the demands for international cable layers) that have deployed ~220kV HVAC export cable, the average project cable weight is ~11,500 tonnes. These cables drove the investment in CLVs with total capacities up to 15,000 tonnes.

HVDC systems, generally in the range of 320-525kV, has supported the emergence of wind farms located further offshore and larger capacity substations (~1.2-2 GW). There are two main types of DC systems, mono-polar or bi-polar. The systems generally consist of two conductors, either laid separately, bundled together or in a coaxial arrangement. Separation of the poles is needed to minimize mutual heating while at the same time close laying results in lower electrical losses and is favored. Most European DC cable systems feature at least two cables laid together, with one cable a positive and one a negative pole. Many of the new European high-capacity transmission lines will also feature a metallic return (which allows the system to operate at 50% in the event of a cable fault) and a fiber optic cable, all laid concurrently.

Again, looking at the European market, which has driven the international fleet of cable layers, 320kV systems are generally driving a requirement for CLVs with two carousels and a cable capacity of ~12,500 tonnes. When we look at 525kV systems, the average cable weight of systems currently in development in Europe for commissioning from around 2028 is ~26,000 tonnes, which is driving the investments in a third generation of cable layers, with capacities of 19,000-29,500 tonnes.

In terms of floating wind, we expect that most connections will feature traditional static export cables. Array cables will connect to either bottom-fixed substations, floating substations and even subsea transmission infrastructure.

### OIL & GAS ELECTRIFICATION

The world is not going to stop producing oil & gas, whether it be onshore or offshore. But there is a trend to address the emissions arising from the production of these hydrocarbons. One solution being developed is to electrify the existing oil & gas fields, with sources including offshore wind. We will touch on three countries deploying offshore wind solutions, often floating wind technology, to decarbonize existing oil & gas operations:

- Norway began electrifying offshore oil & gas platforms from onshore power in the 1990s. Offshore wind is now part of the solution. Equinor currently supplies ~35% of the annual electricity power demand of the five production platforms in Gullfaks and Snorre oil & gas production fields from the 88 MW Hywind Tampen floating wind plat-

form, commissioned in 2023. The government has asked the developer of the 1.5 GW Sørlige Nordsjø II project (Ventyr) to discuss the possibility of electrifying Conoco Philipps' Ekofisk oil field. The 75 MW GoliatVIND floating wind demonstration project aims to supply electricity to the Goliat oil & gas production facility in the Barents via a 75-kilometer export cable. Projects off Vestland in the Norwegian Sea have been identified as potential candidates to produce electricity of offshore oil & gas platforms operating in Norwegian waters. The area is home to Equinor's Troll and Oseberg oil & gas fields, whose partners (Equinor, Petoro, TotalEnergies, Shell and Conoco Philipps) are interested in electrifying the field with offshore wind.

- Scotland's INTOG 2022-2023 leasing round awarded seven oil & gas projects directly connected to oil & gas infrastructure (TOG projects) with a capacity ranging from 3 MW to 1 GW. All INTOG projects will deploy floating wind technology. Of the TOG projects, Harbour Energy plans to electrify the Judy production platform with one 15 MW turbine, TotalEnergies plans to supply its Culzean field with 3 MW of offshore wind and the Green Volt 525 MW project aims to electrify CNOOC's Buzzard production platform.



### Shipboard Nitrogen Generators

We are nitrogen experts enabling the transition to green fuels. The market leader since 1984 with 2500+ shipboard nitrogen systems on LNG carriers, dual fuel ships, and chemical tankers.

[tell me more](https://www.airproducts.com/marine-solutions)  
[MembraneSolutions.com/Marine-Systems](https://www.airproducts.com/marine-solutions)



© Air Products and Chemicals, Inc., 2024 (46246)

## SUBSEA CABLING

- China: Connected in May 2023, CNOOC's Haiyou Guanlan floating wind demonstration turbine supplies part of the power to 13 production facilities in Wenchong oil & gas field via a 5km subsea cable.

The oil & gas electrification segment will likely feature shorter export cable volumes than for commercial scale wind farm exporting to shore connections, but this is still expected to be a growing sector.

## INTERCONNECTORS

Interconnectors are being developed to move power from where it is most efficient to where it is most needed, which can

be in the country or within a wider region. Today, interconnectors not only connect remote locations to main domestic electricity networks but also interconnect countries and regions. These long cables are generally EHVDC. Interconnectors are often bi-directional. Today, large international interconnected grids are being developed to deliver easier, lower cost and more efficient cross-border electricity transmission that allows for a more effective balance of international supply and demand.

Cable layers in this segment are evolving from second generation export cable layers to third generation CLVs with carrying capacity of  $\pm 25,000$  tonnes.

As we can see from the following chart, Europe, Europe-

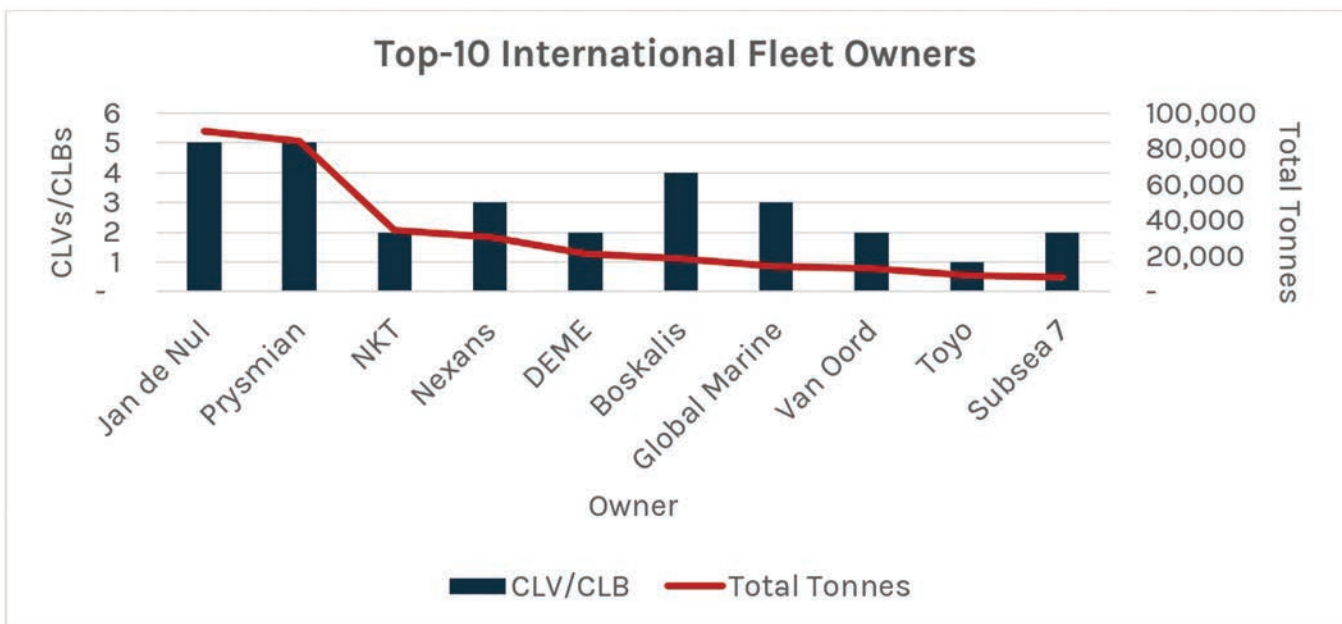
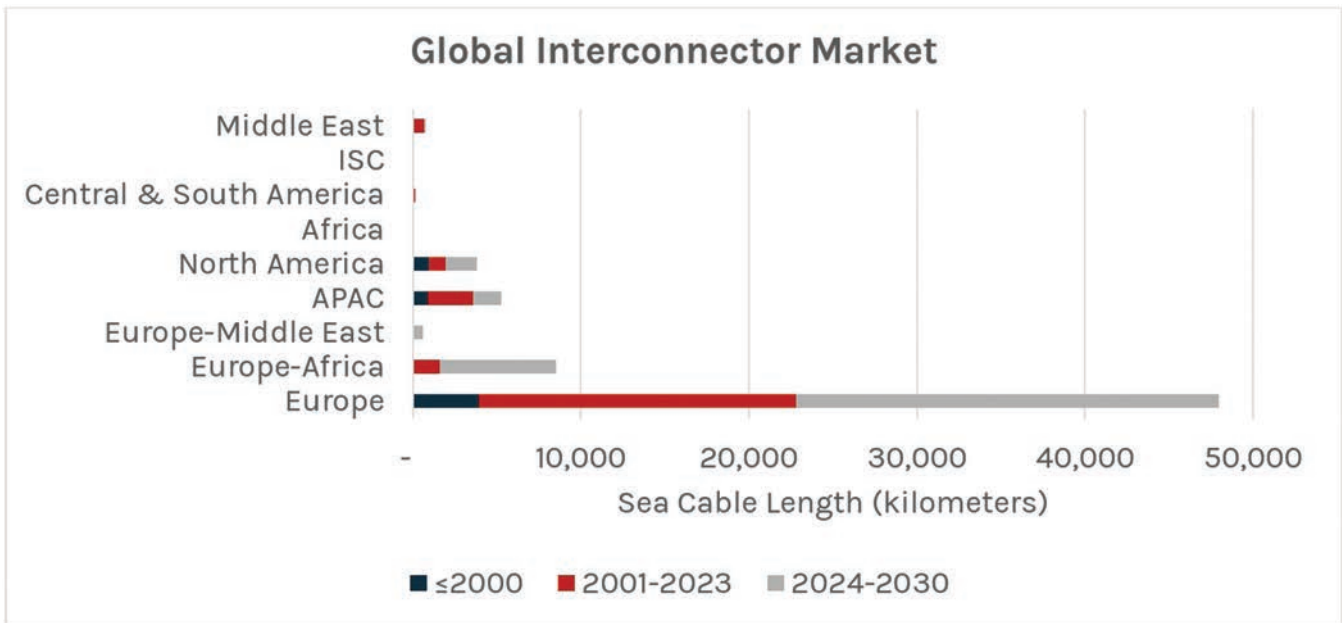

All charts courtesy Intelatus Global Partners



## A GROWING FLEET

Africa and APAC account for most of the market quantity by 2030. We note that the forecast beyond 2030 is significantly less certain than the forecast for 2024-2030, due to a current lack of firm plans, although projects amounting to 140,000 kilometers of interconnectors have been identified, of which ~80% are in Europe and ~16% in APAC. We anticipate that most of these projects will be realized during the next decade.

It is interesting to note that the Europe-Africa interconnectors not only include cables linking North African countries to European countries with Mediterranean coasts, such as Greece, Italy and Spain, but also includes extremely long connectors designed to bring renewable electricity from North Africa to the UK.

### WHO OWNS; WHO BUILDS?

Focusing on the international segment of CLBs and CLVs (in service and on order), we can see that cable manufacturer Prysmian and European EPCI Jan de Nul are the largest players. These two companies are also the most active in the new building segment in the ten-year period of 2018-2027. The five largest CLVs are all under construction and have capacities of 19,000-29,500 tonnes and all feature three carousels, indicating their suitability to simultaneously lay two 525kV HVDC poles and a return cable, seen in large interconnectors and networked offshore wind export grids. Two of these large cable layers are being built by European EPCI Jan de Nul, two are owned by European cable manufacturers NKT Cables and Prysmian and one is being planned by new UK manufacturing and installation player XLCC (minority owned by China's Ningbo Orient Cable). Four of the CLVs will be busy with Ten-

net's 2 GW project in the Netherlands and Germany through this decade and XLCC's vessel is planned to support the construction of the Morocco-UK green electricity interconnector.

VARD is both the largest builder and designer of vessels ordered for delivery in the ten-year period of 2018-2027. VARD designs account for half of the cable layers delivered in this ten-year period.

### A CONNECTED FUTURE

Whatever one's views are on the energy transition, the trend remains for our economies to become increasingly electrified. This means moving ever larger amounts of electricity through on- and offshore networks. Europe/UK and China will be the major drivers for offshore wind cable laying activity for the foreseeable future and the European/UK markets will continue to grow interconnection capacity, to manage the intermittent nature of wind farms, to balance grid loading and to integrate other sources of renewable energy from their own country, region or from another region. All this demand will drive utilization of existing cable layers and support demand for new vessels to meet the specific challenges of installing varied designs and sizes of cable systems.

#### The Author

### Lewis

Philip Lewis is Research Director at Intelatus Global Partners, a firm of business consultants specializing in strategic planning and market analysis.

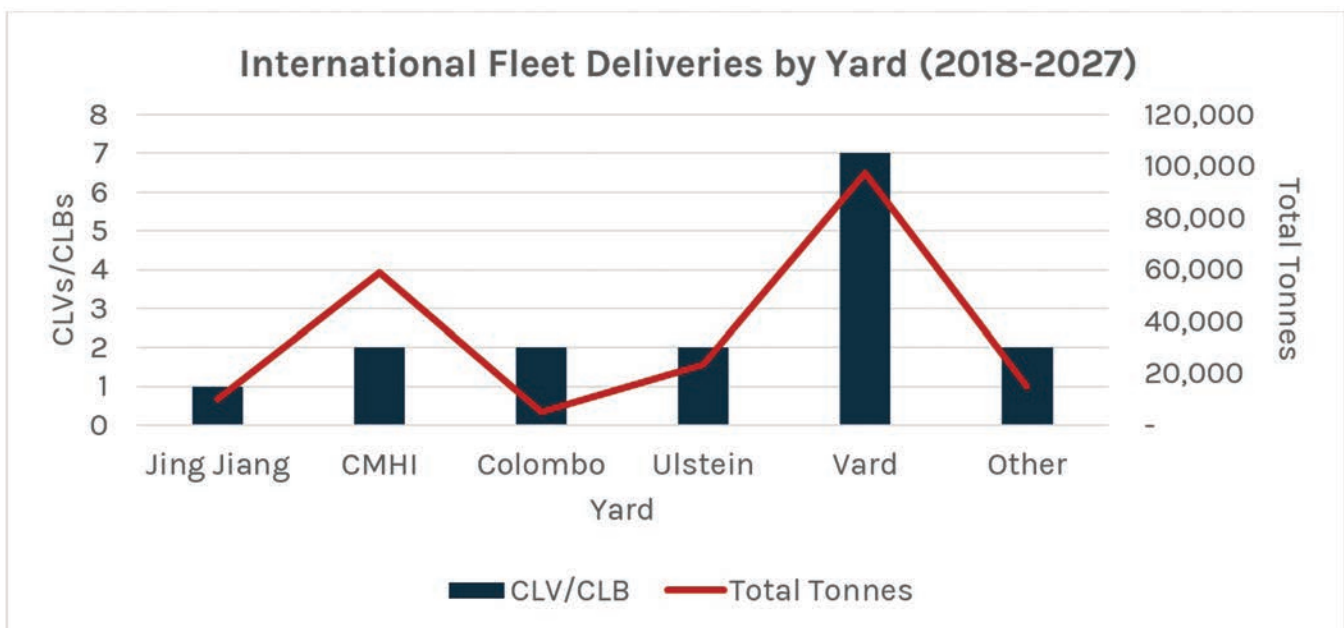

A portrait of Dr. Gunnar Stiesch, Chief Technology Officer of MAN Energy Solutions. He is a middle-aged man with short brown hair, wearing black-rimmed glasses, a dark suit jacket, a white shirt, and a red patterned tie. He is smiling slightly and looking directly at the camera. The background is a blurred office setting with light coming from a window.

MEET THE CTO

Chief Technology Officer  
MAN Energy Solutions

# STIESCH

*As the shipowners stare down **decarbonization mandates** that grow increasingly strict through 2050, the engine makers are at the tip of the spear of this **energy transition** phenomena, working to design and build engines and components that are built to operate on a long and growing list of alternative fuels. We recently visited with **Dr. Gunnar Stiesch, CTO, MAN Energy Solutions**, to take a look inside the research and development process at this global power leader, for insights on **'what's next' in ship propulsion.***

**By Greg Trauthwein**



## PRODUCTION HALL IN AUGSBURG, GERMANY



### **Dr. Stiesch, to begin, can you give a brief career biography with insights on how you came to your position as CTO of MAN ES, as well as your current responsibilities?**

I am what you could call an “engine guy”, having worked with the technology in various functions for close to 30 years.

I was appointed to the executive board of MAN Energy Solutions as a CTO at the beginning of 2023, and my current function involves all responsibility for all our technology and product development activities, including both our two- and four-stroke engines, but also for our turbomachinery-related business.

### **Can you give us an overview of the department under your guise?**

Globally we have roughly 2,000 development engineers, with about 60% related to our engine business. The majority are located in Europe, primarily in Germany and Denmark, and part of our turbomachinery business in Switzerland.

### **Can you discuss the engine test facilities that you have at your disposal?**

For the engines business we have eight engineering sites in six countries which are specialized on engines. That is in Augsburg, Germany; in Copenhagen, Frederikshavn and-Holeby, Denmark; Saint-Nazaire, France; Aurangabad, India; Changzhou, China; and in Busan, South Korea. Almost all of these sites have their own engine testbeds, and also component test rigs to validate our products and technologies before we put them on the market.

In regards to the R&D efforts, Copenhagen is our center for two-stroke technology, with two large research engines and several component test rigs, whereas Augsburg is our primary center for four-stroke R&D activities, including full and single cylinder test engines and component test rigs. We also

have some sophisticated, specialized laboratories for solid materials, and for fuels and lubricants, labs we share for all parts of our engineering.

### **Can you put in perspective how mandates from the IMO to cut ship emissions have helped to shape the work that you and your team do on a daily basis?**

It's absolutely crucial. The technologies are available, but without regulations they will not be cost-competitive compared to fossil fuel technologies. The overall target has been set, but more detailed targets will have to be broken down and be decided within IMO within the next year, coming into force in 2027. That is crucial that this time schedule is met and is not further delayed, because basically you could say it is too late already. The technologies are available, but we need regulations to incentivize investments to make the new technologies, the new fuels cost-competitive compared to fossil alternatives. Another important part is to accelerate the production of green synthetic fuels. Investments in that area are also necessary and they will only start if regulations require the use of those clean fuels.

### **What kind of challenges does the broad diversity of potential fuel choices, particularly with an industry that's run successfully for about a hundred years or more on the same fuel, present to you and your team?**

The first obvious challenge is to make sure that we allocate our resources to the right topics and the correct technologies. As you indicated, what we see at the moment is a combination of biofuels, methane, methanol, and ammonia. Hydrogen is probably something we'll see [more] on stationary applications onshore and not so much on vessels, but the other fuels are serious candidates, and available to a large extent today.

When we look into our ‘crystal ball’ we see that right now,



## MEET THE CTO

methanol has been very attractive in the last two years. We have gained a lot of orders, especially for container vessels, but also [there has been much] interest from ferries and cruise vessels. We expect that to continue to ramp up quickly, with maybe some 30% of all dual-fuel engines being on methanol. We expect ammonia to ramp up towards the end of this decade. Technology will become available soon [but the transition, with ships lasting 25-30 years] will take a very long time.

There is a need to address the existing fleet with retrofits. We are doing this and there is significant interest from customer, too.

[In analyzing the market for potential retrofit candidates] there is a significant number, maybe around 2,000 vessels with two-stroke engines, and another 1,000 four-stroke engines that are potential candidates for retrofit.

**When you change fuels there will be impacts on the engine as a whole as well as the ancillary systems. I know that the potential future fuel spectrum is broad, but can you discuss some tangible impacts you've seen to date?**

A good example may be the two-stroke ammonia engine we are developing. The combustion characteristics of ammonia are very different from any other hydrocarbon fuel: it burns slower, it has different emission types, and also there are different safety aspects to be considered. We need to make sure that we get complete combustion, and we also need to make sure that, for example, laughing gas [N<sub>2</sub>O] emissions are controlled.

Also the exhaust after-treatment will have to be looked at, as with the ammonia engine for example, balancing a potential ammonia slip with nitrogen oxides emissions and making sure it can be fully converted and neutralized in an SCR catalyst. It looks like that is possible, but again, more detailed work is needed.

Looking at the safety system, ammonia is highly toxic, so a safety philosophy needs to be adapted and crews need to be trained to do basic maintenance work at sea. For that reason,

we have entered into cooperation agreements with customers, with ship operators, to set up training facilities and programs for crews.

**Decarbonization is a massive challenge in and of itself, but aside from that, what other technological evolutions are you seeing today that will or could significantly impact cumulatively the life and efficiency of the engines that MAN ES designs, builds, and delivers?**

The other big topic next to decarbonization is digitization, and large marine engines are equipped with smart electronic controls. They have hundreds of sensors around the engine, and with today's technologies, we can make the data available on a vessel and transmit it via satellite to shore to a remote operation center, for example. With that we can give new and much more detailed insight into the operation of the engine, into the health status of the engine, and make sure these equipment runs more safely, more efficiently, more cost-effective than it has ever done before.

At MAN, we offer to our customers a service called PrimeServ Assist, where we utilize this data and propose and suggest mechanisms and steps to always keep an engine in the most efficient state and most fuel-efficient, but also if there is a need for troubleshooting. We have approximately 1,600 vessels connected, and we are gaining more and more experience every day.

**When you look back in your career, can you point to an accomplishment by you or your team of which you are most proud?**

Engine development projects are complex, with dozens of people involved, so it's always a team effort. Nevertheless, I admit that I'm also personally proud on some of the achievements and successful executed projects. The first one is the two-stroke methanol engines which we have developed in

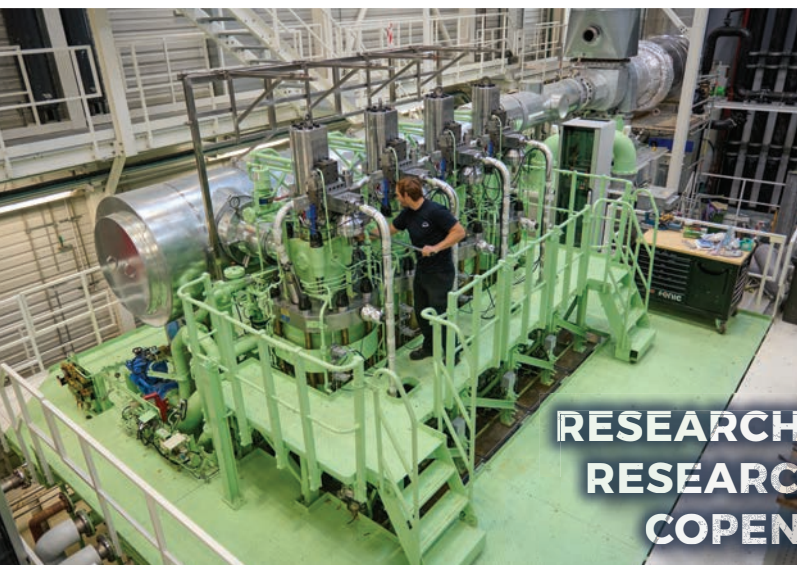





Scan the QR code to watch the full interview with Dr. Gunnar Stiesch



# ENGINE ROOM WITH MAN V48/60CR ENGINE

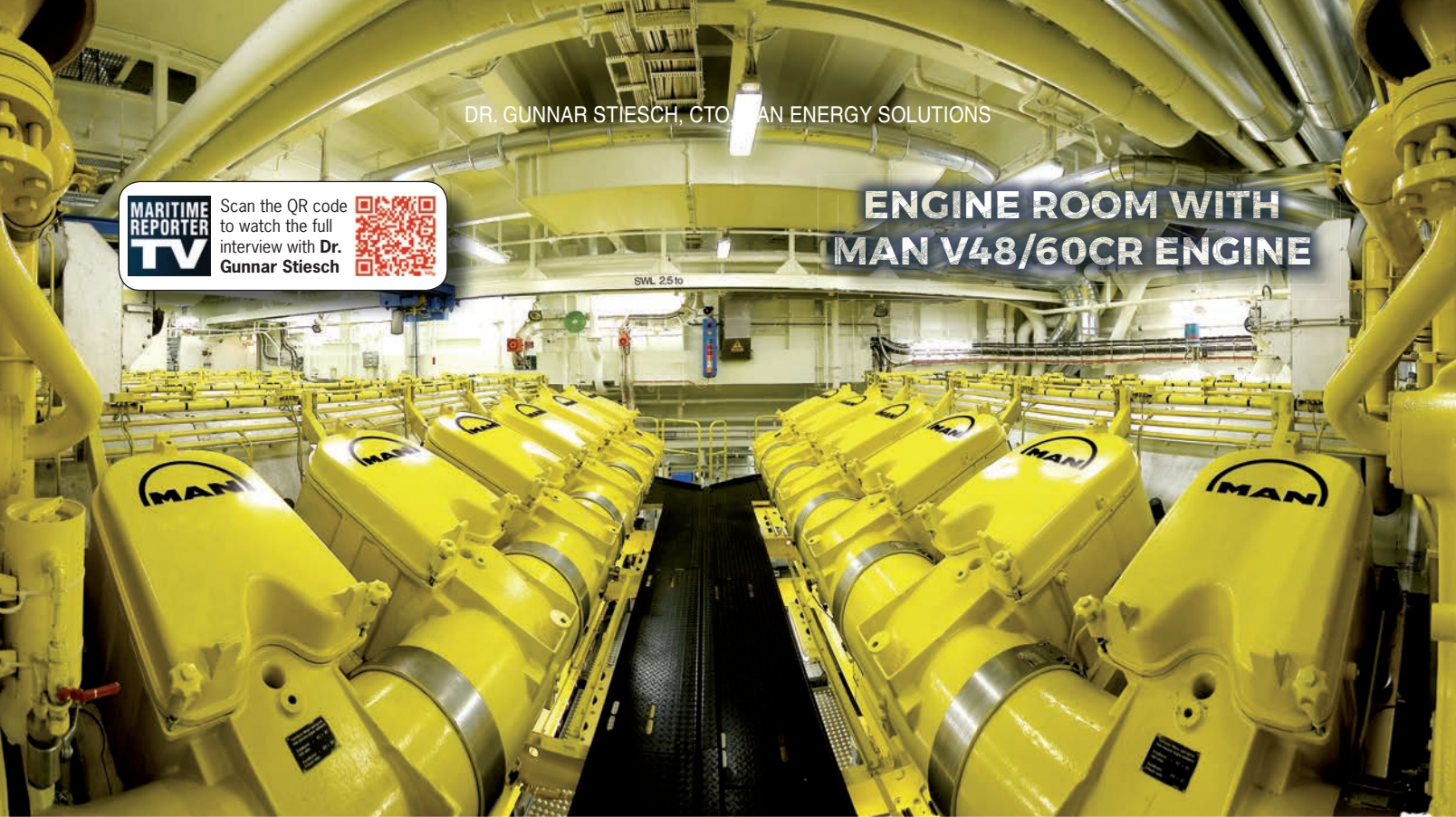

2015, with the first vessel sailing in 2016. It really took off in 2021 with many large orders, especially for container vessels, and today we have more than 200 large two-stroke engines on order, a number have been delivered and are in operation.

The second I would like to mention is on our four-stroke engine side, the development of our all new 49/60 engine platform; an entirely new platform with both inline and V-type engines, both for marine applications, for stationary applications, and prepared for all different kinds of fuel, at sea and on shore. And the first engines, both for marine applications but also stationary have been delivered are now going into operation. This engine family will set a technical benchmark for many years, and I'm really proud on that development too.

### What are your top priorities in the next 12 to 24 months?

A couple of things. On the two-stroke side, finalizing the development of the ammonia engine, with a large first commercial engine ready for delivery end of the year, and then pilot installations and later on roll out to the market. On the four-stroke engine side, it is certainly methanol engines both for new builds and for retrofits, where a large number of engine types will come out in the next couple of years because there's a large interest, especially on methanol on the four-stroke engine side. But also, a priority remains looking at methane engines, on methane slip and reducing methane slip. There we have come a long way. There are two-stroke MEGI engines with close to zero methane slip today, but also on four-stroke engine side substantial reductions have been achieved.



**45 Years of Experience In Humidity Control**

**- Rusting & Corrosion - Prevention Is Better Than Repair !**

**Refrigerant & Adsorption Models Capacities From 17 ppd to 3,173 ppd**



**Refurbishing, Mothballing or General Enviromental Control - EIPL Have The Solutions.**

**Experts In Humidity Management !**

**Ebac Industrial Products Inc**

<b>East Coast Office</b> 700 Thimble Shoals Blvd, Suite 109, Newport News. VA 23606-2575	<b>West Coast Office</b> 2060 Chicago Ave, Suite C7, Riverside. CA 92507
--	--

**Toll Free 1-855-873-6800 [www.ebacusa.com](http://www.ebacusa.com)**

**01 | January 2025**  
Ad close Dec. 20, 2024

## Dredging

E-Magazine Edition

- Technology: Safety Equipment

**Events**  
Floating Wind Solutions  
PVA Maritrends  
Maritime Week Africa

**Podcast:**  
Mega Machines – The Dredgers

**02 | February 2025**  
Ad close Jan. 21

## Cruise Shipping

- Navy Shipbuilding & Repair
- Digitalization: Cyber Security
- Technology: Maritime Coatings & Corrosion Control

**Events**  
CMA Shipping 2025  
Sea Air Space  
Seatrade Global Cruise

**Podcast:**  
Mega Machines – Cruise Ship Systems

**03 | March 2025**  
Ad close Feb. 21

## Maritime Training & Education

E-Magazine Edition

- Technology: Icebreaker Construction & Equipment

**In Partnership with & Powered by**  
**MaritimeJobs.com**

**Podcast:**  
Maritime University Leadership

**04 | April 2025**  
Ad close Mar. 21

## Offshore Energy: Oil & Gas + Wind

- Floating Production & Power
- Deck Machinery & Cranes
- Technology: Maritime Propulsion

**Events**  
IPF Wind Conference • Norshipping 2025 •  
CIMAC Congress 2025 •  
Maritime Risk Symposium • OTC '25, Houston

**Podcast:**  
Mega Machines – The Heavy Lifters

**05 | May 2025**  
Ad close Apr. 21

## Green Marine Annual

E-Magazine Edition

- Technology: Robotic Hull Grooming

**Events**  
Norshipping 2025 • Inland Marine Expo 2025 •  
BariShip 2025 • Green Marine

**Podcast:**  
Maritime Classification Societies

**06 | June 2025**  
Ad close May 21

## Electrification of Everything

- Ship Repair & Conversion
- Marine Salvage
- Technology: Water Jets, Thrusters & Propellers

**Events**  
MarineMoney Week, New York  
Multi-Agency Combat Craft Conference  
[MACC] 2025

**Podcast:**  
Marine Electrification

**07 | July 2025**  
Ad close Jun. 20

## U.S. Navy, Coast Guard & Government Ships

E-Magazine Edition

- Fast Attack and Patrol Craft Builders

**Podcast:**  
Mega Machines – Navy Shipbuilders

**08 | August 2025**  
Ad close Jul. 21

## Shipbuilding

- Artificial Intelligence Onboard
- Ballast Water Management
- Technology: Shipbuilding Tools – Cutting & Welding

**Events**  
Offshore Europe 2025  
SNAME 2025  
Breakbulk Americas 2025

**Podcast:**  
Decarbonization & Ship Design

**09 | September 2025**  
Ad close Aug. 21

## Marine Design Annual

E-Magazine Edition

- Technology: Digital Twins

**Podcast:**  
Emission Optimized Ship Designs

**10 | October 2025**  
Ad close Sep. 22

## Marine Hybrid Propulsion

- Marine Ports & Logistics Annual
- Training & Education
- Technology: Marine Electronics

**Events**  
Europort 2025  
Shipping Insight 2025

**Podcast:**  
Mega Machines – The Future of Maritime

**11 | November 2025**  
Ad close Oct. 21

## The Workboat Edition

- Emission Reduction Technology
- Deck Equipment: Winches & Cranes
- Technology: Marine Gears & Transmissions

**Events**  
International Workboat Show

**Podcast:**  
Mega Machines – Tugboats

**12 | December 2025**  
Ad close Nov. 21

## The Future of Maritime: Alternative Fuels \* Robotics \* Hybrid Propulsion

E-Magazine Edition

- Great Ships of 2025

**Podcast:**  
The Future of Maritime



# THE INDUSTRY'S LARGEST NETWORK OF PRINT, DIGITAL, AND SOCIAL MEDIA

**MARITIME  
REPORTER**  
AND  
ENGINEERING NEWS

**Marine**  
News

**OE** **OFFSHORE  
ENGINEER**

**MARITIME LOGISTICS**  
PROFESSIONAL

**MARINE  
TECHNOLOGY**  
REPORTER

**MAGAZINE CIRCULATION:**

**72,389**  
SUBSCRIBERS

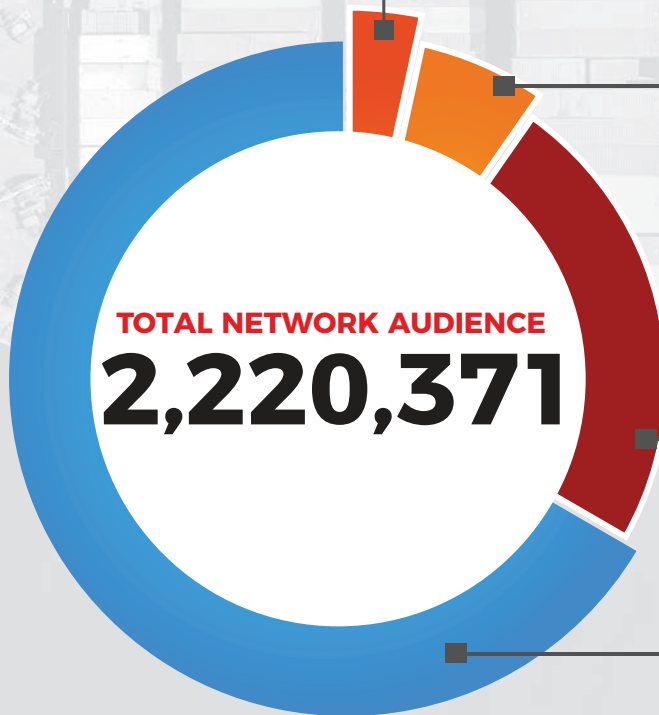

**TOTAL NETWORK AUDIENCE**

**2,220,371**

**MOBILE APPS:**

**80,101**  
DOWNLOADS

**SOCIAL NETWORKS:**

**551,109**  
MEMBERS

**WEB TRAFFIC:**

**1,516,772**  
PAGEVIEWS/MONTH

New Wave Media is the premier media company serving the Commercial Maritime, Shallow Draft Workboat, Underwater Science, and Offshore Energy Industries.

Download our media kits and learn how we can help your company grow.

**WWW.NEWWAVEMEDIA.COM**



IN THE SHIPYARD

# MS AMER



**Undocking of Amera @ Remontowa Shipyard in Gdansk, Poland.**



MS AMERA

# AMERA

## GETS A NEW LEASE ON LIFE



*Cruise ship upgraded in Poland with **Wabtec** engines, **Flender** gears, **Kongsberg** props and thrusters and a whole lot more.*

**By Greg Trauthwein**

Image copyright Phoenix Reisen / BSM Cruise



*“Most other next-generation power solutions that could have been considered require an SCR system. This was not an option for the Amera for construction reasons, as this would have required a new exhaust system and urea storage. The solution from Wabtec is based on an exhaust gas recirculation system. We have already had good experience with such solutions from Wabtec, for example with smaller versions of auxiliary diesel engines on the Amadea. An alternative fuel refit would have not been possible due to space limitations.”*

## **- Tim Mass, Technical Superintendent, BSM Cruise**

**S**hipowners in all sectors face the same decision: build new or refurbish older tonnage. In the booming cruise sector the decision is more pressing, particularly as new construction ships can take two to three years to build, perhaps longer today with global shipyard orderbooks packed full.

When the decision was taken to upgrade the nearly 40-year-old MS Amera, trust for the project landed with BSM Cruise, the technical ship manager of MS Amera, and Wabtec channel partner VMS Group, charged with providing a modern power package to propel the ship for a new generation of cruise ship passengers.

The ship was built in 1988 as Royal Viking Sun at Wärtsilä-Marine-Perno shipyard in Turku, Finland, and operated from 2000 as Seabourn Sun; from 2002 as Prinsendam; and since 2019 as Amera, sailing for the German cruise operator Phoenix Reisen. Throughout its career it has received regular upgrades, conversions and renovations, most recently at the end of 2023/beginning of 2024 at **Remontowa Shipyard** in Gdansk, Poland.

**Tim Mass, Technical Superintendent, BSM Cruise** since 2018 and a long-tenured maritime professional, was responsible for the conversion and retrofitting of Amera, in-

cluding the Tier III engine upgrade, steel construction, IT and hotel technical modifications.

### **FIT FOR REFIT**

Tightening emission reduction regulation globally is the primary driver today for shipbuilding and refit projects, from tugboats to tankers and every sector in between. According to Mass, the conversion and refit of Amera followed this formula, driven by regulation and sustainability aspirations of its owner. Also, the ship was to be upgraded in terms of technology (replacing obsolete machinery like gearboxes) and comfort.

“Phoenix Reisen is constantly investing in the renewal and improvement of its fleet,” said Mass. “Phoenix Reisen relies on traditional cruise tonnage because these ships fit perfectly into the portfolio and suit the taste of the Phoenix cruise customers. BSM Cruise started the first project phase in 2020 by determining different technical options to meet the requirements.”

In 2021, the contracts were signed with VMS for four **Wabtec** main engines and two **Flender** gearboxes, and at the end of September 2023, the ship entered drydock at Remontowa Shipyard in Gdansk, Poland. In addition to the aforementioned suppliers, other major contributors in the project



included **C-Job; ABB; Kongsberg; and On Site Alignment.**

While the biggest part of the project was the completely new engine setup, featuring the high-efficiency main engines and advanced exhaust gas recirculation technology, critical too were the new generators and electrical power solutions, new bow thrusters, the addition of a shore power system and a new antifouling hull coating.

The ship's previous four main engines and three auxiliary engines of the ship were removed and replaced with four new Wabtec 16V250MDC engines.

"MS Amera will be repowered with the cleanest diesel engines available," said **Patrick Webb, Senior Director – Global Sales, Marine & Stationary, Wabtec.** "After all these years of faithful service, the four Wärtsilä – Sulzer Marine Diesel Engines have been replaced with the most innovative clean engine solutions in the world. The four Wabtec 16V250MDC Dual compliant (EPA Tier 4 and IMO Tier III) Simply Clean Marine Diesel Engines make this older lady one of the cleanest cruise ships in the world. These low emission engines take advantage of breakthrough technology design (originally funded by General Electric) and now owned by Wabtec Corporation. These engines are best-in-class clean, quiet, and fuel efficient with no need for any after-treatment, Dox Cabinets, Scrubbers, DP Filters, nor SCR systems. With this simple plug and play solution, the MS Amera was able to receive a full repower with no need for urea tanks or any other space absorbing systems."

According to Mass, the new main engines are connected on one side of the crankshaft via a clutch and gearbox to the propeller for propulsion and on the other side of the crankshaft to an alternator for electric power production. "With this setup there is no need any more for auxiliary engines and the main engines can be operated in optimized load ranges," said Mass. "Each

main engine has 16 cylinders with a cylinder size of 250 mm operating at 1,000 rpm. The rated power per engine is 4,700 kW given a total power of 18,800 kW to the ship."

Key to the selection of Wabtec power was the fact that the exhaust recirculation system ensures compliance with the IMO TIER III requirements without the need of an SCR system and have no urea consumption, said Mass.

Energy efficiency extends down the powertrain. For example, the two new bow thrusters from Kongsberg have a power rating of 1,033 kW each. "The thrusters are differently designed compared to the previous ones as they are fixed pitch and variable speed – previous ones were fixed speed and variable pitch," said Mass. "This allows a reduction in power consumption because the thrusters are only running when they are operated. In standby mode they are not rotating, and therefore don't con-

sume any energy."

In addition, a new DC switchboard together with new alternators, transformers, bow thruster electric motors, and the new shore power connection system were supplied by ABB.

## THE POWER PACKAGE

Selecting the powerplant is always a critical choice in a newbuild or conversion project, and Mass explained the rationale for the move to Wabtec.

"Most other next-generation power solutions that could have been considered require an SCR system. This was not an option for the Amera for construction reasons, as this would have required a new exhaust system and urea storage. The solution from Wabtec is based on an exhaust gas recirculation system. We have already had good experience with such solutions from Wabtec, for example with smaller versions of auxiliary diesel engines on the

detyens.com  
drydock@detyens.com

f in t+ c

QR Code

**Detyens**  
Shipyards, Inc.  
Charleston, South Carolina

"We  
Fix  
Ships"

Ship Repair | Conversions | Drydocking



**IN THE SHIPYARD**

**LINE IT UP:** Alignment of one of the new main engines (right) with generator (left).



One of the new **Flender gearboxes**.



# THE MACHINERY



**IN WITH THE NEW:** Engine room showing two of the four new main Wabtec engines and the engine crew of the "Amera" (Tim Mass, front right).

Image copyright BSM Cruise



**OUT WITH THE OLD:** Removal of one of the old main engines via an port side hull hole.



Amadea. An alternative fuel refit would have not been possible due to space limitations.”

Prior to the refit, the ship was equipped with four main engines which were used for main propulsion and could supply via two shaft generators electric powers for the bow thrusters during maneuvering. All other electric load was supplied via three auxiliary engines. Propulsion was completed via two variable pitch propellers where each was driven by two main engines via a double in/single out reduction gear. All electric load was distributed via a 6.6kV AC main switchboard from which the two bow thrusters and the three air condition chiller units were directly fed. All other ship electrical consumers were supplied via 440V and 230V switchboards. The two bow thrusters were fixed speed variable pitch thrusters.

“After the refit, the ship now has four main engines which have fixed coupled generators which produce 780V AC,” said Mass. “On the other side of the engines, they are connected via a clutch to two double in/single out gearboxes which drive the two variable pitch propellers. There are no more auxiliary engines installed. The electric load is now distributed via a 1000V DC switchboard which directly supplies variable frequency to the bow thrusters and chillers. The rest of the ships consumers is still supplied via the original 440V and 230V switchboards. The bow thrusters are now fixed pitch variable speed.”

In addition, the ship has been refit with a 6.6kV shore connection which can, due to the DC main switchboard, be operated at 50 or 60Hz.

“With the new setup we are achieving significantly more efficient and environmentally friendly ship operations in compliance with IMO Tier III regulations: less fuel consumption (10 to 15% expected), less NOx emissions (approx. 90%), optimized engine layout, more efficient electrical design (DC main switchboard), shore power system, and a low-friction hull coating,” said Mass.

### MEETING CHALLENGES HEAD ON

Anyone that has engaged in an extensive ship refit project knows that challenges abound, particularly with the integration of extensive new machinery and power systems.

“A particular challenge was the coordination of so many different technical teams,” said Mass. “After all, not only the main engines were renewed, but all auxiliary systems were also touched and converted. A lot of systems had to be integrated and aligned with one another.”

Another challenge was tougher to control: Mother Nature.

“The weather conditions were challenging as we faced a very cold and snowy winter in Poland – not ideal for a hull coating. You have to be patient.”





IN THE SHIPYARD

**NEW PAINT:**  
M/V Amera docked  
in Gdansk, hull  
coating in progress.

# IN THE SHIPYARD



**SAIL AWAY:** Undocking  
of the Amera in Gdansk.

Images copyright Phoenix Reisen / BSM Cruise



With that, Mass offers a few bits of salient advice for anyone mulling an extensive conversion project. “Take your time in planning and don’t trust the original drawings. We experienced a few surprises. Only believe what you have seen, measured and verified yourself. An older design can have good prerequisites, but you have to look very closely, if you want to

combine the old with the new.”

Upon completion, MS Amera started again a worldwide itinerary, in the spring of 2024 sailing in South America, the Caribbean and North America. She will then cross the Atlantic to Europe, where to spend the rest of the year including cruises to the Atlantic Westcoast, Norway, Baltic Sea, Iceland, Greenland, Mediterranean and Canary Islands. At the beginning of 2025, Amera will go back across the Atlantic to South America.

“It is interesting that my mariner career started nearly the same year as the inception of the MS Amera,” said Webb from Wabtec. “While she was in her design and build stage, I was in a maritime school preparing for my career launch in New York City. Certainly, as we both circumnavigated around the globe we crossed paths from time to time. With her sleek lines, the 205 meter MS Amera has maintained her youth and attractive shape better than I have! These new engines make this once grand lady a supermodel once again,” concludes Webb.

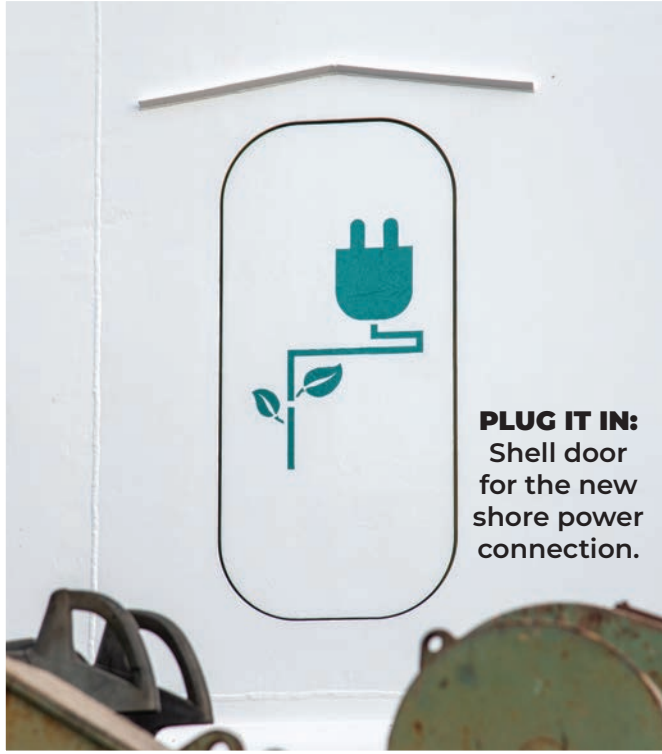

**PLUG IT IN:**  
Shell door  
for the new  
shore power  
connection.



## PRINT AND DIGITAL FEATURED CONTENT

A multi-platform featured content package is a great way to built brand awareness to the industry’s largest verified circulation - in print and digital! With this powerful marketing tool, a professional marine industry writer will help you to create an effective message and communicate it to the global maritime industry. Your message will be seen by decision-makers, purchasers and buyers through various media platforms and websites.

**For pricing or to learn how *Maritime Reporter & Engineering News* and the Maritime Network can help build brand awareness across multiple platforms, contact your sales representative today, or call +1-212-477-6700.**



IN THE SHIPYARD

**Bow Thrusters**  
The two new bow thrusters from Kongsberg have a power rating of 1,033 kW each.



Copyright Phoenix Reisen / BSM Cruise



# VMS Group: Engines, Gears & Engineering

Wabtec channel partner VMS Group combined the propulsion package consisting of four Wabtec 16V250MDC propulsion engines rated 4700 kwm @ 1000 rpm with two Flender twin-in/single out marine gears.

Wabtec L/V250 series diesel engine with the unique EGR technology meet EPA Tier 4 and IMO's tier III emission standards without the use of a selective catalytic reduction (SCR) equipment or urea-based after treatment, offering also the lowest possible footprint and significant weight savings in combination with the custom built Flender marine gear designed to fit the existing foundation and hull structure with minimum steelwork for the retrofit. VMS, in cooperation with the technical team from BSM, designed and fabricated the foundations for generators, engines and gear that adapted to existing vessel foundations with minimum steel work and time savings for the shipyard during the retrofit.

The propulsion layout is complex, with the four main engines operating both as main propulsion through front PTO



to gear and flywheel to shaft alternator covering the full main propulsion and the electrical power of the vessel saving three auxiliary gensets. Wabtec MDC series engines delivered with a front PTO shaft can take full load on both PTO and

flywheel end which gives the advantage to position the engine best suited to the engine room layout and attached pipework like exhaust, which on this installation didn't have the large exhaust pipes crossing the engine room.

## M/V Amera Refit Specifics

Vessel Owner	Phoenix Reisen	Engines	4 x Wabtec 16V250MDC engines, 4 x 4,700 kW
Ship Management	BSM Cruise	Gearboxes	Flender
Project Supervision	BSM Cruise	Naval Architecture/Engineering	C-Job
Shipyard	Remontowa Shipyard	Electrical Power, Automation	ABB
Entered Shipyard	September 2023	Propellers & Bow Thrusters	Kongsberg
Exited Shipyard	February 2024	Machinery Alignment	On Site Alignment
Total Project Cost	\$54 million	Ice class	1C
Gross Tonnage	39,051 GT	Shore power	Yes
LOA	205 m	Speed	14 to 18 knots cruising speed
Beam	29 m	Passengers	835
Depth	7.25 m	Cabins	425
Passenger decks	9	Classification	Lloyd's Register
Flag	Bahamas		

# HEAVY HAULER

## UHL ADDS TO ITS FLEET, WORKS ON NEW SHIP DESIGN

*Just shy of 10 years old, **United Heavy Lift (UHL)** recently welcomed its 19th ship to the fleet, an **F900 Eco-lifter**. In advance of the ship delivery festivities in mid-July, we had the chance to chat with **Andreas Rolner, Managing Director of UHL**, a man who with his father parlayed cumulative experience in the heavy lift business into **one of the world's largest heavy lift companies**.*

By Greg Trauthwein





“Shipping has always been a part of my DNA,” said Andreas Rolner, noting his family moved from Denmark to Germany when he was a young boy, and his father Lars joining SAL back then in 1980. Andreas officially started his own shipping career in 2006, but unofficially his summer holidays were spent like many adolescents in strong shipping families: with his father in the [SAL] office.

After about 10 years of experience traveling the globe working in shipping, in 2015 “Lars and I decided to launch UHL.”

Today, UHL is part of the United Shipping Group based in Hamburg's HafenCity, with a worldwide team of 150 employees in 10 offices globally.

#### **FROM THE ASHES [OF ZEAMARINE]**

“End of 2014, beginning of 2015, the market was a different one,” said Rolner. “We saw that German banks were becoming ship owners, a situation they did not want to be in.”

So team father and son started off doing commercial management on a transparent, open book basis for banks.

“We took fixed commissions; we did cash flow projections; we took over all of the services [where they didn't want the hassle]. We started running these ships as our own, and, with time, we made enough cash also to charter vessels on our own.”

The big break came with Zeamarine going out of business, allowing UHL to take over the F900s.

“Back then, it was a big gamble,” said Rolner. “Vessels were expensive. [But we] phased out the older tonnage, and we went from this small operator doing commercial management now to placing our own orders and now looking at a new generation of vessels. It's been a nice voyage.”

“We took over the vessels from Zeamarine when they went bust four years ago,” said Rolner. “With the latest new building [UHL Fable, a F900 Eco-Lifter, a multi-purpose (MPP) heavy lift vessel, built at the **CSSC Hudong Shipyard** in Shanghai] we're at 19 vessels, 19 identical F900 eco-lifters, [which gives us] the youngest, most modern and most homogeneous fleet in the market.”

While Rolner is not particularly enamored with an odd number fleet size of 19, he does not see the need to order more F900s, though he does admit “we are developing our successor to the ship. In shipping, of course, it's all about timing. When is the right time to approach the yards? When it's the right time to look at financing? If we had a crystal ball, it would be nice, but no, right now, it's a difficult decision.”

He said the new ship design is almost complete, and in the coming months it may approach shipyards for build quotes.

#### **IN FOR THE LONG HAUL**

From the start, the UHL vision has been long-term, and with that it has a vessel contracting philosophy that seeks strong,



## UHL Fable in front of Hamburg's Elbphilharmonie

long-term contracts for big projects; but at the same time it has the vessels and crews to tap the spot market, too.

“Right now, for the rest of this year, the vessels are basically booked out,” said Rolner. “Until 2028, we already booked 30% of the capacity of the fleet for the long-term projects, and I think that will go up maybe to around 50%. I think it's a healthy 50/50 [split between contracts and spot].”

The wind turbine business specifically, renewable energy in general, has been a big driver in the heavy lift sector for years. “Especially onshore has been massive, that's where the volume is,” said Rolner. “But it is shifting fast. We see that oil and gas is coming back on track,” effectively expanding UHL's exposure across energy markets.

While the energy markets are fluid, growing and in need of heavy lift, UHL is not immune from the challenges that provide headwinds for all international shipping today, namely:

- **One-Way Roads:** “We see 95% of the export is out of Asia; there's not a lot of export coming out of Europe. In the end, we might have to send the vessels back empty just to cater for the contracts that we have in place.”
- **Freedom of Navigation:** With Iranian-backed Houthis attacking ships at will in the Red Sea and a prolonged low-water situation at the Panama Canal, two major shortcuts have been eliminated and/or minimized. “We are routing around the Cape, and that's costing us 10 days each way. If you have commitments of three to four shipments every month, it's quite challenging.”

### THE FUTURE FLEET

As any shipowner knows, there are inherent advantages to operating a fleet of identical ships, and though “on a piece of paper they all look alike, there are a few small differences on all the vessels,” said Rolner.

In particular, the two newest ships – Fable and Fresh – have cranes that sit on a crane pedestal that has been raised by six

meters. “This allows us to load much more spacious cargo on the deck, so we have much more lifting height,” said Rolner. “We changed the hatch covers too; they're strengthened and they're a different size compared to the other ships: they're 40-ft. size instead of 20-ft.

Despite the minor nuances, Rolner said having 19 [almost] identical ships “gives us a lot of flexibility when it comes to planning,” particularly when accounting for blank sailings from Europe to Asia and the additional time needed to avoid the geopolitical mess, rockets and drones targeting commercial shipping in the Red Sea.

“If our clients have a situation where cargo needs to be delayed for a month, we're very flexible on finding new solutions ... we don't have to re-engineer the whole thing,” said Rolner. “We can switch things around easily, and it's a very cost-effective solution. On the other side, it's also easy for us when we need to bid on projects. We know that we're going to have four to five vessels on the continent every month and the same in Asia, so we don't have to calculate in a lot of pre-ballast.”

The ‘Eco-Lifter’ name far exceeds marketing brochure fodder, and in fact UHL recently issued its second ESG report and can boast efficiencies of 30-50%. While much energy is spent discussing the maritime fuel transition, digitalization and automation in the name of efficiency, Rolner admits the efficiencies his company sees “is not actually rocket science:” UHL has a young fleet running modern, clean two-stroke engines and sporting updated design and cargo handling premised on the longer and heavier loads of the day.

“If you take our average age of the fleet being three years compared to the general average age, which is more than 20, of course, something has happened on the engine side as well, but also on hull design. If you take also the amount of cargo that we can transport on these vessels compared to the consumption that we have, that is just a very simple reason,” said Rolner.

When mulling the ‘fuel of the future’, the path for Rolner and UHL is a bit fuzzier, premised predictably on alterna-



ANDREAS ROLNER, MANAGING DIRECTOR, UNITED HEAVY LIFT

## UHL Fable United Group Team



tive fuel price and availability. At any given time up to 50% of the UHL fleet may operate on the spot market, meaning availability of fuel would largely dictate the ability to take a cargo, not an attractive option for any shipowner.

“Our industry, especially the project cargo business, are not the trendsetters,” said Rolner. “The container vessel owners, might be [looking at] methanol, ammonia, or LNG, but they can create the infrastructure. Us being worldwide trampers, we don't know if we're going to Australia tomorrow or to Greenland. We need to make sure that there's enough fuel wherever we go, and right now there's no infrastructure that can replace oil.”

That said UHL, particularly in the design of its new ships, will consider biofuel and dual fuel, and additional energy saving devices to set the efficiency bar even higher. “We're not going to be the front-runners in our industry, we're going to be fast followers instead ... I think that's better,” said Rolner.



**MARITIME REPORTER TV**

Watch the full interview with Andreas Rolner @



**Anchor**  
MARINE & INDUSTRIAL SUPPLY, INC.

**ENDLESS SUPPLY OF MARINE HARDWARE**

REQUEST A NEW CATALOG • SALES@ANCHORMARINEHOUSTON.COM

**AUTHORIZED YOKOHAMA FENDER DISTRIBUTOR**

- New, Used and Rental Options Available
- New Harness Installation Or Harness Repair with Quick Turnaround
- Foam and Pneumatic Fenders Available

**NEW & USED**

**LARGEST INVENTORY IN THE USA**

- Anchors
- Chains
- Fittings
- Towing
- Hardware
- Wire Rope
- Cordage
- Blocks
- Dock
- Fenders
- Buoys
- Spill Boom

IN STOCK & READY TO SHIP  
WORLDWIDE  
**24/7**

(800) 233-8014 • ANCHORMARINEHOUSTON.COM

# GETTING THE NUMBERS RIGHT

*It was never going to be realistic to expect treated ballast water to have zero viable organisms on discharge.*

**BY WENDY LAURSEN**

**T**he G8 guidelines that define the type approval process for ballast water treatment systems were initially agreed at the IMO before any systems had actually been developed.

The IMO had already been working on the issue of invasive species being transferred around the world in ballast water for a couple of decades. It was on the radar back in the 1970s. At MEPC 31 in 1991, the IMO adopted voluntary guidelines that focused on non-release of ballast water, ballast water exchange or discharge into shoreside reception facilities. On-board treatment systems were mentioned as a possibility for future research.

In the years after the adoption of the Ballast Water Management Convention in 2004, treatment systems grew in type and number, and over 80 gained type approval. However, G8 specified a limited salinity range for testing these systems, and there were no requirements to test with fresh water or differ-

ent water temperatures. Concern had also been raised about the need to only monitor the effectiveness of the disinfection process for five days. In any case, G8 was only guidance and results could reflect the individual nature of the test water obtained near a particular testing house.

Then the US Coast Guard refused to embrace treatment that rendered organisms permanently non-viable although not necessarily dead. This caused OEMs that use UV treatment to meet two different standards to gain global approval for their systems.

Fast forward to MEPC 81 in March this year, six months before all ships have to comply with the D-2 standard (requiring treatment rather than just exchange), depending on survey anniversary, and the details are still being resolved. After much discussion and three rounds of votes, text for the interim guidance for ships ballasting in challenging, high sediment water was finally approved.





*“In reality, for all practical purposes, we have just started talking about challenging water quality and malfunctioning ballast water treatment systems.”*

– **William H. Burroughs,**  
 Founder and CEO of Monstrant Viam

## The Nature of the Beast

The control of invasive species has proved to be an ongoing battle against the diversity and tenacity of life. The round goby epitomizes the ability of some species to not only survive but thrive in new environments. It is a voracious and aggressive fish; a renowned invader that has been transferred to many countries. Originally from the Black and Caspian Seas, it thrives in a range of salinities, warm or cool water, and on a wide variety of foods.

It’s now at home in the Great Lakes, along with zebra and quagga muscles, amongst others, many considered to have arrived in ballast water. No new instances of invasive species have been reported since ballast water exchange was fully implemented by ships before entering the seaway, but lakers, operating only within the seaway, have spread those already introduced further. A study published this year found that untreated samples from lakers could contain thousands of eggs or resting stages of organisms per cubic meter of ballast water.

Despite its success in the Great Lakes, ballast water exchange hasn’t been considered adequate because even vessels with no ballast on board have been found to harbor living organisms in sediments left in the bottom of their tanks, ready for dispersal when ballasting is undertaken again.

## Counting on Performance

It’s tempting to believe that the efficacy of treatment systems has improved over time as the industry has developed and regulations have been tightened. A study of 228 ships during 2017–2023 found that this was not the case. Nearly all ships were compliant with the D-2 standard for indicator microbes and organisms  $<50\mu\text{m}$ , but almost half of all samples exceeded the limit of 10 viable organisms per cubic meter for organisms  $\geq 50\mu\text{m}$ .

Inspection house SGS has played an important role in developing sampling and testing techniques for taking representative samples of the large volumes required to verify that ship’s discharges meet the D-2 standard. The company has

conducted compliance testing and commissioning testing on over 2,000 vessels worldwide.

“Our sampling experts often work alongside crews during sampling events, providing valuable training,” says Cameron Talbot, Australian Marine Services Manager at SGS Australia. “As compliance and voluntary due diligence sampling become more widespread, I anticipate that crews will gain expertise in critical sampling aspects, such as the disposal of filtrate and the maintenance of sampling points. Regular sampling will also offer vessel operators better insights into whether their systems and procedures meet the D-2 performance standard, leading to higher compliance rates and enhanced protection of the marine environment.

“Currently, compliance is often assumed rather than verified.” He says, many port state controls may require assistance to build capacity for this task or may need to collaborate with specialized, accredited laboratories.

## Pointing the Finger

By September 8, 2024, an estimated 40,000 ships will have installed a treatment system. The phased approach to compliance between entry into force on September 8, 2017 and September 8, 2024, was widely seen as a victory for common sense, as it gave OEMs, shipyards and shipowners time to install so many systems.

However, it has also been the start of more problems for shipowners. Manoj Subramanian, International Chamber of Shipping (ICS) Marine Technical Adviser, says it is still common for a ballast water management system to be bypassed during ballasting, and it is increasingly difficult for relevant stakeholders to determine what went wrong, whose fault it was and how to improve the situation. It is important to note, he says, that it is significantly more difficult for the ship to meet D-2 standards once the ballast water management system is bypassed.

“Shipowners who are put in position where they must bypass the system are often considered ‘guilty’ and can get a bad environmental reputation, as it is seen as choosing an inferior, cheaper ballast water management system, but they are caught



*Shipowners who are put in position where they must bypass the system are often considered ‘guilty’ and can get a bad environmental reputation.*

– **Manoj Subramanian,**  
International Chamber of Shipping (ICS)  
Marine Technical Adviser

in a difficult regulatory situation.

“Rather than holding the shipowners solely responsible for bypassing the system, the inherent flaws in the system must be addressed. Therefore, ICS strongly advocates for a more consistent regulatory approach that results in a more uniform and stricter set of requirements from the type approval stage of a system to the implementation stage of the Ballast Water Management Convention.”

ICS has identified several root causes that crews might have for bypassing their ballast water management system: unfamiliarity with the equipment onboard the ship and gaps in the information provided by the manufacturer’s manual, lack of timely support, machinery not fit for purpose in real-life conditions and a lack of availability of spares.

## Redrawing the Battle Lines

An experience building phase was established at MEPC 71 in 2017 and then a review plan was approved at MEPC 80 in 2023 that allows for amendments to the convention in 2026.

“This is 10 years too soon,” says industry veteran William H. Burroughs, Founder and CEO of Monstrant Viam, who has variously worked on class, OEM development, research and regulation development projects. “In reality, for all practical purposes, we have just started talking about challenging water quality and malfunctioning ballast water treatment systems. That is not going to be solved for another decade or more. Amendments are being drafted for the Convention now. It is important to get approval for the use of mobile BWMS either for contingency measures or for portable systems shared across a fleet of vessels.”

He is working to get recognition for “ballast water reception ready” treatment systems that have pipework that enables ships to discharge to shore. “These retrofits will be 10% of the cost of installing a ballast water management system and nothing compared to the lifecycle maintenance and operating costs of a system.”

Shoreside treatment systems will serve a regulatory purpose when onboard systems fail to meet D-2, and they could also be a source of pre-treated, fully IMO compliant ballast water to ships, he says. It would, however, require a change to US Coast Guard regulations.

## A Victory Unnoticed

For now, there’s little point trying to determine whether the number of invasive marine species is declining. Such studies are tricky at best as is the conclusion that a species has been introduced from ballast water when other mechanisms (biofouling, aquaria release, etc) could also be feasible. And, by definition, the Convention’s limits on the number of viable organisms allowed to be discharged are above zero.

If the transfer rate of potentially invasive species is never going to be zero, are complex, expensive and time-consuming mitigation efforts worth it? Organizations such as the Intergovernmental Science-Policy Platform on Biodiversity and Ecosystem Services could point to the billions of dollars lost in infrastructure and biodiversity as justification for action, but a study of the Port of Douala, Cameroon, offers a more focused approach for port states.

Cameroon receives 95% of its merchandise via maritime transport, and Douala receives ballast water from 41 ports and 20 eco-regions. Examining specific trades, such as those from: Antwerp, Durban and Dakar, the researchers evaluated the invasion risks that could be mitigated by compliance with D-2. They modelled the probability of a species being an alien based on biogeographic dissimilarity, the probability of its introduction based on ballast water volume, voyage time and treatment efficiency, and the probability of its establishment based on the similarity of factors such as salinity and water temperatures between the two ports. They concluded that the D-2 standard would reduce the probability of biological invasion at Douala by at least 97%. At least 97% but not 100%.



## BALLAST WATER MANAGEMENT SYSTEMS

After much discussion and three rounds of votes, text for the interim guidance for ships ballasting in challenging, high sediment water was finally approved at MEPC 81.

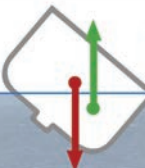

Image courtesy IMO

Ballast water sampling.



Image courtesy ICS



# GHS

General HydroStatics

**Software for Naval Architects**  
Stability | Strength | Seakeeping

*GHS 19.00 is our most reliable and comprehensive version yet.*

Features include:

- \* New wind force method for wind stability:
  - Fully 3D method.
  - Analyze wind forces from any axis.
  - User defined shielding distance.
  - Graphic display of active & inactive wind surfaces.
- \* MAXVCG unlimited trims/LCGs.
- \* DAMSTAB manual layer enhancements
- \* Drag & drop support for run, geometry and print files.

\* GHS Load Monitor (GLM) provides operators the ability to quickly check the safety of present and anticipated loading conditions. Special versions of GLM can be produced to meet special requirements.

---



**Creative Systems, Inc.**  
P.O. Box 1910 Port Townsend, WA 98368 USA  
+1 (360) 385-6212 | sales@ghsport.com  
[www.GHSport.com](http://www.GHSport.com)

For 52 years, the software that naval architects love.



## IN THE ENGINE ROOM

Image courtesy Rolls-Royce

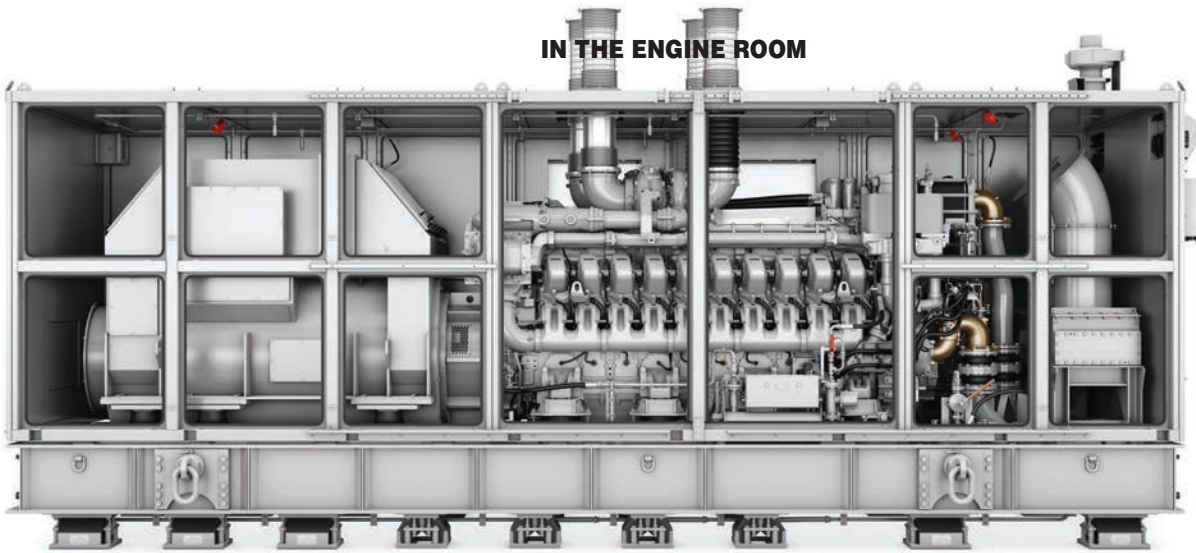

Four MTU 20V 4000 gensets will provide a total power output of 12MW for propulsion and onboard power supply for the U.S. Navy's Constellation Class Guided-Missile Frigates.

# NAVIES INCREASINGLY EYE ALTERNATIVE FUELS

**Alternative fuels are not top of the list of naval requirements for gensets, but they are inching their way up.**

*By Wendy Laursen*

**T**he naval world is largely exempt from the decarbonization pressure faced by commercial shipping, but it can't ignore it entirely. As a famed naval strategist once said: "Fuel stands first in importance of the resources necessary to a fleet."

Navies must therefore consider their fuel supply options carefully given that commercial shipping is currently rewriting supply and demand dynamics.

Indeed, DNV surveyed some 130 naval, shipyard and fuel supply stakeholders from 12 countries in 2022 and found that logistics (fuel availability / fuel change flexibility) was ranked as one of the top four concerns by 79.2% of respondents. More than 83.3% of respondents chose biofuels as an alternative fuel over ammonia and methanol, and the majority believed that non-combat vessels would be the first to adopt alternative fuels, rather than frigates and destroyers.

Engineering research teams at the University of South Carolina are already designing a non-carbon fuel supply chain for the U.S. Navy. Funded by the Office of Naval Research, the three-year project aims to reduce the Navy's CO<sub>2</sub> emissions through alternative fuels that could be implemented in the Navy's next-generation fleet.

Oak Ridge National Laboratory (ORNL) and Fairbanks Morse Defense (FMD) are collaborating on the development and integration of alternative fuel technologies into engine technologies based on the reasoning that global decarbonization efforts are expected to limit the availability of diesel fuel and drive-up costs. In anticipation of this shift, the Department of Defense is exploring options to transition to low-lifecycle carbon fuels such as methanol, ammonia, hydrogen and biodiesel.

Many OEMs are ready for biodiesel. The MAN 175D engine, for example, has been formally approved for operation on biofuels. These gensets feature in a recent order for four new European anti-submarine warfare frigates. The first engines and generator sets are scheduled for delivery in August 2025 with Damen Naval expected to start delivering the frigates to the Royal Netherlands and Belgium Navies from 2028.

Late last year, Anglo Belgian Corporation (ABC) unveiled the third engine model from its multi-fuel ready Evolve engine platform. The Evolve 6EL23 joins the entry-level 4EL23 and the 20EV23 at the top end of the Evolve range. A defining feature of the Evolve engine platform is its multi-fuel and future-proof design. The adaptable cylinder head design enables effortless transition from liquid fuel to dual fuel, and to 100%



## NAVAL GENSETS

Image courtesy MAN ES

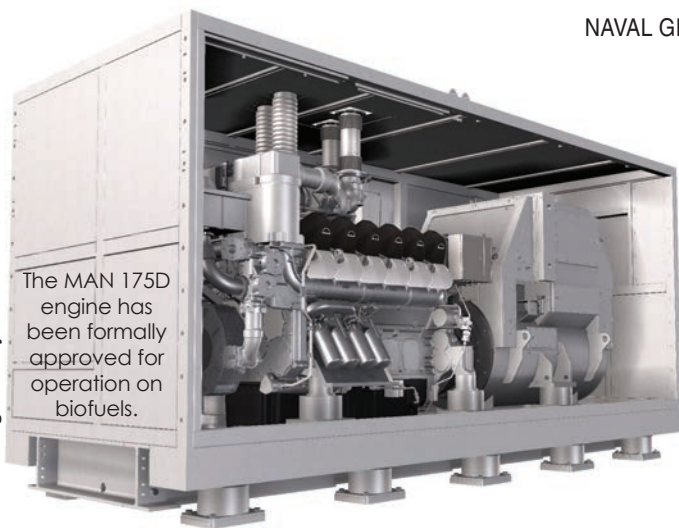

The MAN 175D engine has been formally approved for operation on biofuels.

Efficiency was key for the choice of Wärtsilä's 31 engines for a new Canadian Coast Guard polar icebreaker.

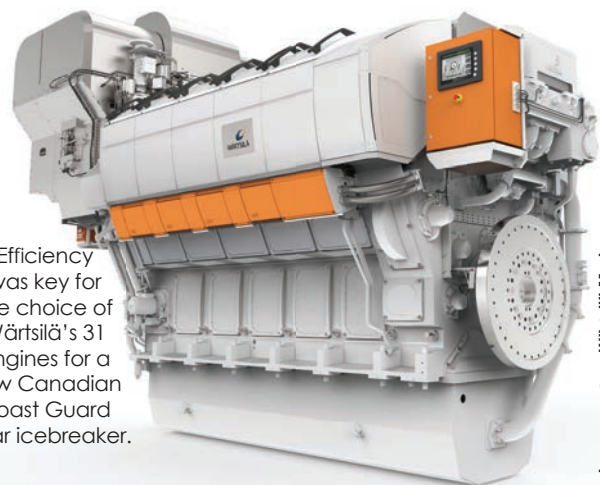

Image courtesy Wärtsilä Marine



A defining feature of the Evolve engine platform is its multi-fuel and future-proof design.

Image courtesy ABC

gaseous fuels, eliminating the need for a specific fuel commitment.

The Evolve platform is very suitable for naval applications, says Jean-Christophe Van Acker, Sales Manager for military projects, as it has:

- A 1200RPM engine, allowing max power at 60Hz for diesel electric applications
- A full range of engines allowing the customer to take main engines and generator sets from the same family from 1,000-8,000kW
- An improved power to weight ratio in the V models
- Two-stage turbochargers for higher efficiency and longer range
- Mechanical versions for simple maintenance
- A special Navy rating of 400 kW/cylinder.

Different navies are considering alter-

natives to diesel and studying the pros and cons of switching or adding extra fuel options to their ships, Van Acker says, including diesel electric or diesel hybrid solutions to reduce their footprint and add redundancy in their power needs. This is important as many navies are increas-

ingly looking for multi-mission vessels.

“New is the growing involvement of the EU via the European Defence Fund programs which aim at increasing the collaboration between countries on the subject of design, interoperability and strategic sourcing and industrial capabilities,” he says.

# Drill All Day, Every Day

## HMD920 Mag Drill

- 2-3/8" Diameter x 3" Depth
- 100% Hougen Reliability
- Hidden Motor Cord
- Available Accessories
- 3 Speed - 250/450/700 RPM
- Two Year Warranty

Hougen

800-426-7818 SERVICE • INTEGRITY • RELIABILITY HOUGEN.COM

## IN THE ENGINE ROOM



*“Different navies are considering alternatives to diesel and studying the pros and cons of switching or adding extra fuel options to their ships.”*

– **Jean-Christophe Van Acker**,  
Sales Manager for military  
projects, ABC Engines



*“Alternative fuels such as hydrogen, ammonia or green methanol could constrain of naval operations which may not be compatible with the limited supplies and potential bunkering locations of those fuels.”*

– **Romain Cazal**, Global Market  
Leader – Navy Ships, Bureau  
Veritas Marine & Offshore



*“We have updated our engine controllers with faster processors, which assist our naval and coast guard customers with faster load ramps.”*

– **Simon Riddle**,  
GM, Naval Sales –  
Wärtsilä Marine

Romain Cazal, Global Market Leader – Navy Ships, Bureau Veritas Marine & Offshore, says that alternative fuels such as hydrogen, ammonia or green methanol could constrain of naval operations which may not be compatible with the limited supplies and potential bunkering locations of those fuels.

While the risks of fire or explosion related to the use of hydrogen limit the potential use of fuel cells aboard surface vessels, fuel cells can be considered for submarines and could provide longer underwater autonomy when combined with conventional propulsion, he says. Air independent propulsion systems, powered by different generations of fuel cells, have been demonstrated by some countries.

Despite consideration of the potential for alternative fuels, noise, vibration and shock characteristics remain important naval genset features, particularly for combat vessels. Klaus Schmidt, responsible for engineering naval systems at Rolls-Royce Power Systems, notes that four MTU 20V

4000 gensets will provide a total power output of 12MW for propulsion and on-board power supply for the U.S. Navy’s Constellation Class Guided-Missile Frigate program, including the first ship in the class, USS Constellation (FFG-62).

This genset model is an evolution of earlier models that combines updates from the civil engine range, such as more digitalization, as well as naval-specific features. These features include sophisticated fuel injection systems, shock resistant crank case materials and deep oil pans for extended performance during incline. Acoustic requirements are becoming more stringent as detection systems become more sophisticated, says Schmidt, and Rolls-Royce is working with suppliers on enhanced mounting systems, including active mounting.

Simon Riddle, general manager, Naval Sales – Wärtsilä Marine, points to the need for engines to have the ability to deliver fast response and maneuverability. “We have updated our engine

controllers with faster processors, which assist our naval and coast guard customers with faster load ramps. This is a common platform that we offer for the entire range of Wärtsilä engines.”

Fuel efficiency is important for existing fuels, not just future fuels, and efficiency was key for the choice of Wärtsilä’s 31 engines for a new Canadian Coast Guard polar icebreaker being designed and built at Seaspan Vancouver Shipyards. The engines will meet the requirements for the long operational range required for the vessel’s employment in Arctic waters.

Riddle is also seeing interest in alternative fuels, and he points to the technology link between commercial and naval markets: “We are seeing a general interest from naval vessels, as well as coast guard and research vessels, for alternative fuels, especially at a European level,” he says, but due to the conservative nature of naval vessels, they are focused on following commercially proven engine technologies which are robust and reliable.



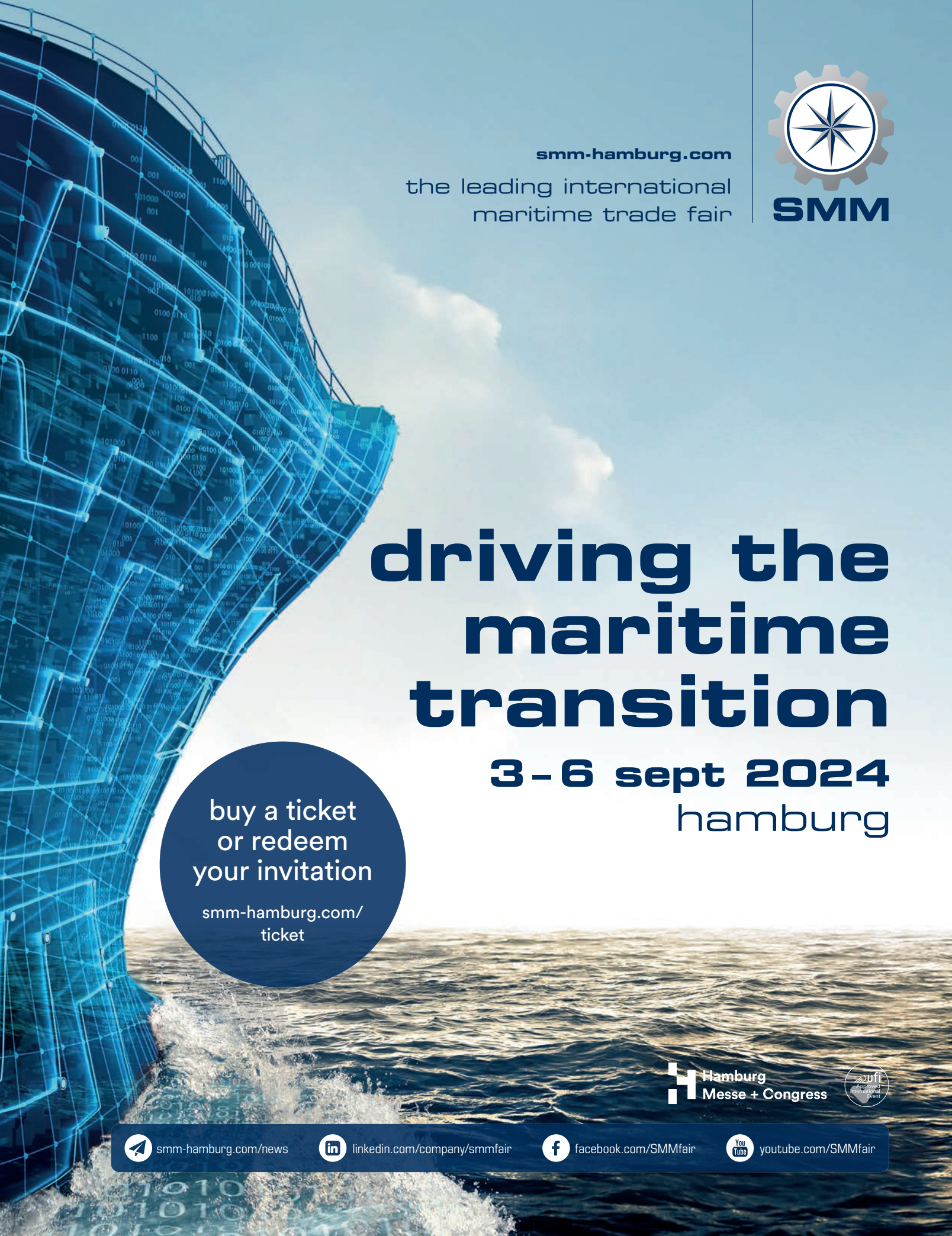

[smm-hamburg.com](http://smm-hamburg.com)

the leading international  
maritime trade fair



# driving the maritime transition

**3-6 sept 2024**  
hamburg

buy a ticket  
or redeem  
your invitation

[smm-hamburg.com/  
ticket](http://smm-hamburg.com/ticket)

 Hamburg  
Messe + Congress



[smm-hamburg.com/news](http://smm-hamburg.com/news)



[linkedin.com/company/smmfair](https://linkedin.com/company/smmfair)



[facebook.com/SMMfair](https://facebook.com/SMMfair)



[youtube.com/SMMfair](https://youtube.com/SMMfair)



# The Building of E





# Europe's Gas Carrier Repair Hub

*EDR Antwerp Shipyard has undergone a complete rebrand, but the transformation is far more than skin deep. **Philippe Trouillard**, Commercial Manager, discusses with **Maritime Matters: The Marinelink Podcast**, not only the transformation of the yard and its facilities, but also too that challenges of successfully competing with much cheaper repair yards in the Far East; and insights on an exciting new **electrostatically applied paint in the drydock** which has shown the potential minimize overspray and **save 40% in paint applied**.*

*By Greg Trauthwein*

**Phillippe, to start us off, please give a brief professional biography with insights on your position and responsibilities at the shipyard.**

The maritime life has always been in my blood. This industry is so demanding that you have to be made for it. I started at the Nautical Academy – Deck in 2004, graduated as Master in 2008 and achieved highest distinction in 2009 in Maritime Management and Transport Management. Initially the plan was to go sailing, but I opted for a career ashore. Gradually I evolved towards the Marine Insurance and Finance. After 10 years, I decided that I needed to return back to my roots – ships, and what is closer than working for a shipyard. At EDR Antwerp Shipyard I have a primary role as Commercial Manager and Marketing Manager. I'm also handling legal, contracts and insurance along with GDPR. A significant portfolio of activities, but having knowledge in and of every sector is convenient and time-saving.

**Can you give us a 'by the numbers' overview of the company that give size and scale to your operation?**

We are the largest shipyard in Benelux area and one of the largest ship repair and conversion yards in North European continent. We dock approximately 60 vessels every year in four different drydocks, and repair around 150 vessels at our 2,500-m long repair berths in the Port of Antwerp Bruges. With our team of 700, we also undertake approximately 1500 technical interventions in the Port of Antwerp Bruges and ports in the vicinity thereof.

**I know that EDR Antwerp Shipyard is celebrating its 10th anniversary next year, but its roots go back to the 1990s. Can you give an overview of the facilities history and its**

**contribution to the maritime industry?**

The roots of the company were started in the early 90' with Engine Deck Repair NV. This company was born to undertake and serve technical interventions and repairs on board of ships in the Port of Antwerp. Gradually the company portfolio of clients and activities expanded and resulted that EDR was active as subcontractor for steel repairs in the drydock of the Port of Antwerp, at that time being managed by Antwerp Shiprepair. EDR became subsequent partner in a new consortium Antwerp Drydocks after ASR went belly up. In 2014 we took over the entire consortium and started managing the entire shipyard facilities in Antwerp. At that time it was already obvious that the site where we were operating was significantly neglected by our predecessors and our management decided to undertake one of the largest (maybe even the largest) shipyard renovations in Europe. In 2020 our core activity was more focused on drydocking, so we rebranded the company to EDR Antwerp Shipyard, which to date is still the commercial name of Engine Deck Repair nv.

**What, specifically, are the 'crown jewels' of the shipyard, by equipment or expertise, what differentiates EDR Antwerp Shipyard from other ship repair yards?**

If we would look to "hardware" and facilities, you cannot ignore the amount of work and funds invested in our premises. Our entire shipyard infrastructure is renewed or currently being renewed with aim to be completed end 2025. This includes a new 21,000-sq.-m. maritime logistical center; 18,000-sq.-m. of renovated and new workshops; renovation of our drydocks, reactivation of rail-mounted cranes and renovation of existing 100-ton cranes. One of the icons in the Port of Antwerp is certainly our new office facilities as well. All was designed and

## SHIPYARD IN FOCUS EDR ANTWERP SHIPYARD

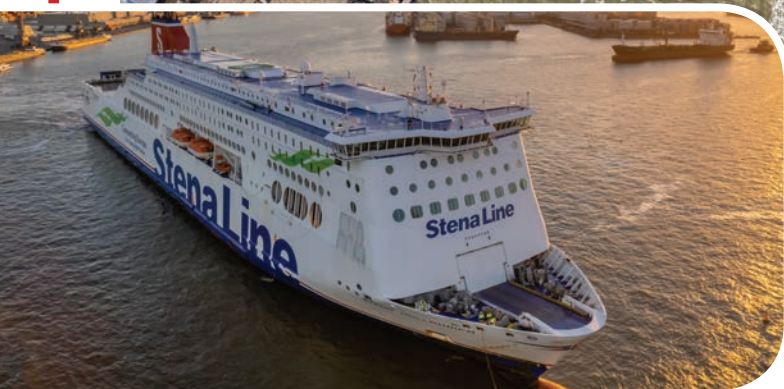

Watch the interview on the **Maritime Matters:** The Marinelink Podcast by scanning the QR code:



constructed to the highest environmental standards. Hence, by execution, EDR Antwerp Shipyard is becoming one of the leading ESG performing shipyards for shiprepair and conversion in the Heart of Europe. However, these facilities aside, the secret sauce of our success is surely the teams working for EDR Antwerp Shipyard – our FTE and dedicated subcontractors are like family who will go the extra mile to exceed expectations of our clients. We have a strong stakeholder management in order to increase engagement throughout. We differentiate on the market by communication and transparency. We shouldn't hide the fact that docking in Europe will be more expensive than Turkish or Asian shipyards. This is pure logic and the result of various social, environmental, and quality factors. Hence, when owners decide to dock at EDR, on time and in budget will be elemental.

### Can you discuss in depth one project – either ongoing now or recently completed – that you feel best demonstrates the yard's capabilities?

Selecting just one is hard. But what comes to mind at first instance is the ongoing thrive for innovation during project execution. Last month we executed with PPG the electrostatic painting of a vessel, resulting in significant overspray reduction and up to 40% savings on paint volume. Talk about a quick ESG win-win situation!

### This is a transcendent time in maritime, with fuel transition, digitalization and automation driving change to the way in which ships are built and outfitted. How is the shipyard investing in technology or people to meet the challenges ahead?

Now that the shipyard renovations are as good as completed, we can apply for GTT approval. We are already working on gas vessels (excluding cargo tank operations), but we want to offer a one-stop-shop for LNG fueled vessels or LNG carriers. Our teams on all levels are obliged to follow LNG training courses. Still the war for talent acquisition and retention is real. We work with 21 different nationalities at our yard!

Our focus on ESG performance is driven by the question we pose loudly. With vessels being built green (EEDI) and operated optimally (EEXI/CII) and even scrapped green, why is no one talking about maintaining, converting, and retrofitting vessel at a green shipyard? This is, for us, very striking. Applying marine sails, alternative fuel retrofitting, ultra smooth paint applications, bulbous bow retrofitting .. etc. in locations where social, safety/health and environmental governance is not as important goes against all logic. Yes, new technologies will be the basis for a more green shipping environment. To which transition this will bring us is also unknown to EDR and we therefore discuss various innovations with specialists and makers. That is why it's also very important visit and represent EDR during various maritime exhibitions in the world.



# ALL PATHS LEAD TO CLEAN WATER @ MARINFLOC

Marinfloc debuts an online library of professional content to deliver insight on wastewater treatment trends, products and servicing. **Martin Gombrii, CEO Marinfloc Sales and Production, Marinfloc**, discussed with *Maritime Reporter TV* the company and its mission.

**M**arinfloc is a 28-years-old company which is focused on solving a simply stated but technically complex maritime problem: ensuring only clean water is discharged overboard. Today, it has in the market more than 2,500 treatment units in principally four different segments: bilge water treatment, sewage treatment, offshore water treatment, and exhaust gas water treatment, which cumulatively to date has treated more than 200 million tons. Most recently Marinfloc added to its industry leadership by creating a series of professional maintenance guidance videos. “It’s actually an extension of the video content presented on the HMI screen on the treatment unit,” said Gombrii. “The new generation of seafarers like to get their information from video, so by having this inside the engine room in the control cabinet, they can access useful information instruction videos. However, we wanted to expand this offering to also our users that has older integration of treatment systems so they can access these videos on this website”

## Lifecycle Maintenance Support

As most anyone on any vessel can attest, the dearth of technical spec on ancillary equipment is problematic as ship and equipment age. The level of support varies widely by product, system and OEM, and the education specifically on water treatment systems in advance of serving on a ship is sparse at best. This is where Marinfloc steps up.

“I think this is a really important topic, because I believe that quite a few engineers can agree that the amount of training they got at the maritime university” on wastewater treatment systems is very limited, if existent at all, said Gombrii. “We have our own training program. We have trained more than a thousand engineers through the years. We can do it at our office, onboard ships and in (our customers) offices. We also have our double decker bus (which allows us to) visit ship owners universities. But I believe, again, this video content is really the way to go to make sure that those on board have the information right in front of them.”



Marinfloc’s WhiteBox system

Image courtesy Marinfloc

While training competence is a focus, so too is new product and system development as the maritime industry collectively faces increasingly stringent water and air emission restrictions. To that end, earlier this year Marinfloc launched its water treatment system for EGR, with a 12.5 tons per hour capacity, “required for big ships that produce a high amount of condensate,” said Gombrii. In particular, Gombrii notes that the energy transition will spur more wastewater for treatment – particularly with methanol as a marine fuel.

Marinfloc’s WhiteBox system is designed as a failsafe system for the overboard discharge of water, “designed so that no water with oil content above the set limit can accidentally be pumped overboard,” said Gombrii.

Positioned between the oily water separator and the overboard valve, the Whitebox is designed to prevent non-compliant bilge water discharge, helping to ensure operations remain within the regulatory bounds of MEPC 107(49).

The Whitebox guarantees consistent monitoring of all vital discharge data and is integrated with the vessel’s GPS to help provide transparent and accountable operations with recorded data on oil content, valve settings and flow metrics.

Marinfloc is also part of the ‘digitalization’ discussion, currently developing a data analysis program to allow more proactive condition-based monitoring.

The region's largest trade event for  
the project cargo and breakbulk industry

# BREAKBULK

**AMERICAS OCT 15-17 2024**

George R. Brown Convention Center

[americas.breakbulk.com](https://americas.breakbulk.com)



*Business deals for digital solutions are fraught with risk and shipping companies need to choose software vendors wisely.*

# A MATTER OF TRUST: The Million-Dollar Question of Software Vendor Selection

**T**he rapid pace of technological change makes it challenging for shipping companies to implement sustainable digital solutions that can generate value over time. Focusing on long-term partnerships with vendors that understand your evolving business needs and offer future-proof solutions is a prerequisite for successful software investments, says OrbitMI.

“Tomorrow’s needs will require more innovation, so understanding a company’s roadmap for digital transformation is really important. Close client-vendor collaboration with trust and transparency is necessary to ensure solutions are the right fit for the company’s process automation requirements and are also adaptable and scalable as needs change,” explains OrbitMI CEO Ali Riaz.

Technology adoption requires investments in time, money and effort but selecting the right solution can be difficult

amid the cacophony of competing vendors, so due diligence is vital in software decision-making to avoid the pain of wasted resources from failed projects farther down the line, according to Riaz.

This requires a thorough internal assessment process prior to making software investment decisions to evaluate current systems and workflows, identify areas for improvement, determine the problems that need to be solved and establish the desired goals of process automation, such as cost reduction, emissions control, compliance reporting or safety improvements.

## **Plotting Course for Tech Adoption**

“The initial evaluation stage is essential to plot a course for what the company wants to achieve at a strategic level so that it can research solutions able to meet its specific needs, look-



*“Collaboration between solution providers, shipping and logistics companies, and most importantly, the very people that will be expected to work with new technologies, is key to their successful integration.”*

**– Ali Riaz, CEO, OrbitMI**

ing at the longer-term gains, and avoid buying into those that are not fit for purpose,” Riaz explains.

Shipping companies are under mounting pressure to adopt new technologies for operational efficiencies to meet demands for regulatory compliance and must also navigate a confusing software marketplace following the proliferation of myriad digital solutions over the past decade or so.

Data from research firm Thetius indicates digital transformation in ship operations and management technology is a \$11 billion industry with around 600 players and a compound annual growth rate of about 4.5%.

Against this backdrop, companies face challenges in finding the best tools and sourcing solutions that remain relevant as the industry evolves and business needs change. The fast pace of technological advancement can result in solutions becoming outdated quickly, according to Thetius’ study ‘Navigating New Financial Seas’.

But Riaz says an abundance of data and rapid adoption of new software do not necessarily amount to digital transformation, which is defined as enhancing business performance by integrating people and technology to make operational processes more efficient and profitable.

#### **Vendor Evaluation Criteria**

As well as having a strategic and structured approach to technology adoption with clearly defined goals, a further priority is proper software vendor evaluation criteria with a view to long-term partnership, he says.

The ability of a vendor to collaborate, both with clients and other third-party suppliers, should be a key factor for shipping companies making software investment decisions, according to Riaz.

“Without collaboration in the maritime tech industry, the burden of integration and therefore value creation is left with

the end-user. It is a bit like selling car components and expecting the customer to put it together, and not many people want to do that,” he says.

This is also an issue highlighted by the Thetius study ‘Avoiding the Digital Divide’ that states: “Many organizations are still implementing digital and automation projects in silos, largely due to a lack of alignment between departments and industry-wide fragmentation.

“Collaboration between solution providers, shipping and logistics companies, and most importantly, the very people that will be expected to work with new technologies, is key to their successful integration.”

Riaz points out that a lack of integration presents a business risk as companies with several ‘black box’ systems from different suppliers may be left high and dry with unsupported and outdated systems if one or more of these vendors goes out of business or is acquired.

#### **No ‘One Size Fits All’ Solution**

“It is unrealistic to assume that any one vendor can provide a ‘one size fits all’ solution covering all aspects of ship operations. Vendors must realize they are part of an ecosystem and must collaborate within this ecosystem through data-sharing to best serve customer needs and deliver value through innovation,” he says.

The Orbit vessel performance system developed by NYC-based software-as-a-service company OrbitMI integrates multiple APIs from various vendors to create intelligent connected workflows, using data analytics with AI and machine learning to provide real-time actionable insights for faster voyage decision-making to support efficiencies, cut costs and reduce emissions.

“Integrated, holistic solutions that are also integrable with existing IT infrastructure can provide the necessary system



agility and scalability to adapt in line with the evolving needs of the business, as well as future regulatory and other changes,” Riaz says.

As a founding member of the industry group Get SET Maritime, OrbitMI helped develop the independent Software Evaluation Toolkit (SET Maritime), providing a useful checklist for technology adoption, which can be freely downloaded here.

An important consideration in vendor selection is a human-centric view of software implementation. “Focus on end-user needs with a non-disruptive approach that respects existing business processes rather than trying to change them,” Riaz says.

### **Empathetic Vendors, Tailored Solutions**

Riaz believes shipping companies should seek empathetic solution providers that understand the challenges a company is facing and are willing to work together with them to come up with tailored solutions that are simple to implement and make life easier for the end-user, which will accelerate value creation.

Companies should be able to pilot the software without cost to test its functionality and effectiveness. A feedback loop for user input is necessary to make adjustments before full implementation, according to Riaz.

Balancing the cost of technology adoption with expected payback is clearly a prime concern for shipping companies, so it is necessary to assess the total cost of ownership (TCO) including initial costs, implementation costs and ongoing maintenance fees. This TCO analysis should be calculated prior to making software investments.

A further benefit of a close client-vendor collaboration is that the performance of the software can be continuously monitored post-implementation to optimize workflows and processes based on data and user feedback. It can be beneficial to engage a software vendor able to handle all kinds of data and can standardize processes as they are



MMC International Corporation manufactures vapor control valves, quick connect coupling flanges, product sampling equipment, and its various product measurement instruments, which meet or exceed the standards for “intrinsically safe” equipment set by national governments and certifying agencies around the world.

MMC’s primary products include cargo UTI measurement devices and product sampling for closed and restricted applications, tank gauging and sampling stations, deck valves (vapor locks), CL couplings and CL deck cover and other retail items for the maritime petroleum and chemical transport industry as well as land based petro-chemical facilities.

MMC is widely acknowledged for its long history of technological innovation, dependability, and quality of its products.

**MMC International Corp.**  
Inwood, New York USA • 1-800-645-7339  
Fax: 516-371-3134 • www.mmcintl.com • info@mmcintl.com  
MMC (Europe) Ltd. (01670) 738789 • info@mmc-europe.co.uk

being automated to create added value.

Thetius states in ‘Avoiding the Digital Divide’: “Making use of process automation requires a level of trust, not just across the organization implementing the automation, but also between the end-user and supplier. Transparency and openness between stakeholders are the building blocks required for a trusted relationship.”

### **Data Accuracy a Key Factor**

The study also emphasizes the importance of working with reliable and trustworthy vendors that have robust data governance and standardization policies to safeguard clients’ valuable data. In this regard, it is relevant for the shipping company to ask questions about a vendor’s experience in automation projects, track record of deliveries and understanding of associated risks.

Data accuracy is another important criterion in vendor selection as the quality of decision-making and potential for value creation is ultimately determined by the reliability of data inputs used in analytics, according to Riaz. “Incorrect data can lead to dangerous decisions,” he cautions.

Recognizing the industry need for data assurance, OrbitMI is working closely

with class society Bureau Veritas (BV) under their strategic partnership to develop solutions based on trustworthy, validated data, including their integration with Veristar Green, a convenient, cloud-based application designed to help ship-owners stay up-to-date and comply with the IMO (EEDI, CII, DCS), EU-ETS, EU-MRV and UK-MRV regulations.

“By working with BV, we are making data quality our highest priority,” Riaz concludes.

### **The Author**

## **Marshall**



Steve Marshall is a business writer with long experience in maritime and offshore media, having worked for leading industry publications TradeWinds and Upstream, and now with media consultancy Blue-C.

# Tech Files

Innovative Products & Systems

## Austart: ATS203 Engine Air Starters

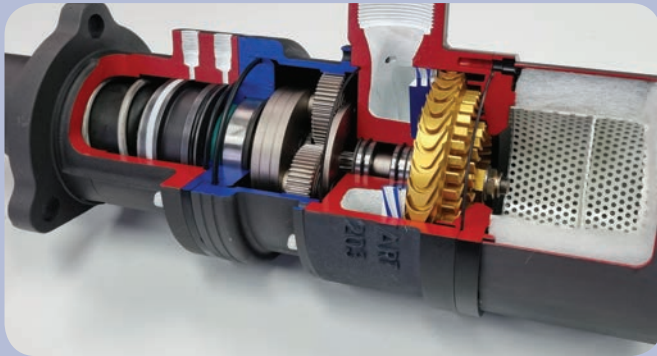

Austart

Austart launched the ATS203 Engine Air Starters. Designed for marine, industrial, and oil & gas applications, the ATS203 Engine Air Starters are engineered to provide unmatched starting power for diesel and gas engines.

Key features include:

- **High Power-to-Weight Ratio:** Ensures efficient starting

of large engines with minimal air consumption.

- **Durable Construction:** Built to withstand harsh environments, including mining, marine, oil and gas, and power generation sectors.
- **Maintenance-Free Operation:** The ATS203 features a lubrication-free design, reducing downtime and maintenance costs.
- **ATEX Certification:** Certified for use in hazardous environments, ensuring safety and compliance with international standards.

“The ATS203 represents a significant leap forward in air starter technology,” said Dave Rawlins, Business Development Manager at Austart. “Our Engineering team has worked tirelessly to develop a product that not only meets but exceeds the expectations of our global customers and in the most demanding industries.”

[www.ussales@austart.com](mailto:www.ussales@austart.com)

## Warrior Edge 500

ESAB’s Warrior Edge 500 CX system makes it possible for both new and experienced welders to achieve excellent welding results without a complex set-up process. It has built-in connectivity and comes with a subscription to the InduSuite WeldCloud Fleet online software application. RobustFeed Edge CX also features a new digital gas control technology called TrueFlow that improves welding quality, saves gas and helps avoid weld defects caused by improper flow rates.

The Warrior Edge 500 CX has a rated welding output of 500 amps at 60 percent duty cycle for synergic MIG/flux cored, pulsed MIG, Stick, gouging and Live TIG.

[www.esab.com](http://www.esab.com)



## TVRO Antenna

Cobham Satcom unveiled its most advanced maritime satellite TV antenna, designed primarily for use on cruise ships and mega yachts. The 3.7 meter Sea Tel 370s TV is a solution designed to expand on-board access to the highest quality programming anywhere in the world, while significantly reducing lifetime technical costs. The Sea Tel 370s TV leverages the newest generation Sea Tel Integrated Marine Electronics (IMA) platform. The TVRO antenna features automatic C-band switching between circular and linear polarization.

[www.cobhamsatcom.com](http://www.cobhamsatcom.com)

## SLP Side Channel Pump

SERO Pump Systems presents the new SLP high-performance pump for providing methanol to dual-fuel engines on seagoing vessels. It is available in three versions with flow rates from 1 to 30 cu.m./hr. The modular design concept of the side channel pump provides a safe high-pressure casing and was developed in accordance with the IMO-IGF regulations. Type approval from the relevant classification societies will be granted by the end of this year. Low viscosities, which are a particular challenge for many positive displacement pumps, especially at higher temperatures and high differential pressures, are easily handled with the side channel pump.

[www.seropumps.com](http://www.seropumps.com)

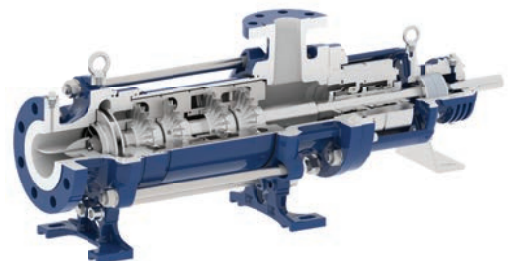



# Tech Files

## Innovative Products & Systems

### 250kW Hydrogen Fuel Cell

Sydrogen enters the maritime market with a 250 kW fuel cell power module. Developed in a collaboration signed with Shanghai Hydrogen Propulsion Technology Co., Ltd. (SHPT), this aims to accelerate the adoption of hydrogen technology in the shipping industry. This 250 kW hydrogen fuel cell power module, incorporating advanced cooling systems, is scalable from kW to MW for large and small vessels, and capable of accepting reformed fuels. Developed in Singapore for the international market, this maritime fuel cell power module will convert hydrogen from various sources and produce clean electricity without carbon emissions.

At the heart of this innovative solution is Sydrogen's proprietary metal bipolar plate technology, SydroDIAMOND, which is designed to offer durable, high-performing components for the fuel cell stack. The technology is expected to significantly enhance the longevity and efficiency of maritime fuel cell systems. The system is scheduled for availability in 2025.

[www.nti-sydrogen.com](http://www.nti-sydrogen.com)

### Cold Pad Fastening Technology

Cold Pad, an engineering company with bonded fastener technologies, has secured \$7.7 million in funding to accelerate the development of its cold bonding product line. Cold Pad's bonding technology and non-intrusive fastening solutions offer an alternative to traditional welding and drilling. The funding will enable Cold Pad to expand from offshore and oil and gas markets to other sectors, including wind turbines, nuclear power, shipping and civil engineering.

The company's patented heavy-duty bonded fasteners, known for their ease of installation and possibility of removal, ensure durability that lasts for decades, even in harsh marine environments. Cold Pad has introduced a new product line of anchor points for steel, offering quicker installation, enhanced safety, and greater reliability compared to existing bonded technologies. Cold Pad's technology is set to significantly impact the wind turbine sector by reducing

the consumption of rare earth elements and steel. For instance, and for large wind turbines, Cold Pad's innovation is expected to save up to 100 tons of steel per wind tower, translating to approximately \$327,000 in savings and 180 tons of CO2 saved per tower.

[www.cold-pad.com](http://www.cold-pad.com)

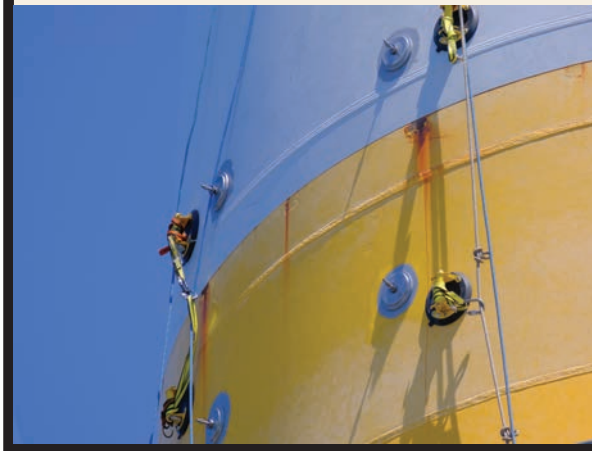

## WinGD: X52-S2.0 Compact Two-Stroke Engine



WinGD said it successfully completed type approval and factory acceptance testing for its X52-S2.0 engine, a compact, medium-bore two-stroke engine. The tests at Yuchai

Marine Power Co (YCMP) confirmed the engine's performance and compliance, while the prototype project validated its ease of assembly and maintenance.

The X S series succeeds the RT flex50 and RT flex58 engines and is available in 52cm and 62cm bore sizes, with confirmed orders already for diesel, LNG and methanol configurations and an ammonia fuel option under development. The combination of small footprint and best in class fuel efficiency – around 10g/kWh lower than equivalent RT flex engines, a saving of around 4% depending on operating profile – make the new platform ideal for vessels requiring a compact, medium-bore solution.

The type approval tests followed similar successful tests for the larger X62-S2.0 engine at Dalian Marine Diesel in April. The first order for the X52-S2.0 was received in February 2023 followed by a second order with iSCR, WinGD's on-engine NOx abatement solution, in July that year.

# In the Shipyard

Green Ship Designs & Deliveries

## SV Juren Ae sets Sail

*SV Juren Ae* (IMO no. 1021245) was delivered to the Marshall Islands Shipping Corporation (MISC) July 31, 2024, a 'low carbon' vessel funded by the International Climate Initiative (IKI), built at **Asia Shipbuilding** in Geoje City, Korea and classed by KR. *SV Juren Ae* is a 48-m, 300 dwt supply vessel, the result of a collaborative effort led by the German Society for International Cooperation (GIZ) through its project 'Transition to Low-Carbon Sea Transport in the Republic of the Marshall Islands' for the German Ministry for the Environment, Nature Conservation, Nuclear Safety and Consumer Protection (BMUV) since 2017.

Partners of the project include KR, the University of Applied Sciences Emden-Leer in Germany, MISC, Asia Shipbuilding Co. Ltd., and naval design company Kostec Co. Ltd. in Busan.

Developed at the maritime campus of Emden/Leer University of Applied Sciences, *SV Juren Ae* is powered by a partially-automated sail system designed by German naval designer HSVA, adapted from a traditional Indonesian sail design. This "Indosail-Sailing Rig," complemented by installed PV units and a hybrid drive system, is projected to reduce CO2 emis-



Copyright: GIZ LCST

sions by approximately 80% compared to similar-sized ships.

The vessel's hybrid power system consists of a propeller and engine that are used for slow-speed maneuvering, while the propeller can also function as a turbine to generate electricity via a hybrid gearbox and generator, a propulsion set up which allows a service speed of approximately 12 knots under sail and around 7 knots with the auxiliary diesel engine. It also is outfitted with a battery rack charged by excess wind power, which powers the vessel's electric drive during low-speed operations.

The ship is intended to offer domestic sea transportation within the Marshall Islands and the Pacific Region.

## Hong Kong Fireboat

**Incat Crowther** partnered with Guangzhou-based **AFAI Southern Shipyard** to design and deliver the first of two new emergency response vessels for the **Hong Kong Fire Services Department**. Capable of travelling at speeds of up to 41 knots, the vessels boast a low draft and are designed for missions in both deep sea environments as well as hard to reach coastal locations. Maneuverability is bolstered by the inclusion of four **Hamilton** HTX52 waterjets.

The vessels have been designed to accommodate up to 300 people including patients and people rescued from emergency situations. In addition, the vessels feature two rescue jet skis, port and starboard knuckle boom cranes, two dual fire monitors with foam fighting capability, telescopic flood lights for nighttime operations, and a helicopter winching platform on the upper deck. The second vessel is under construction and both are expected to be in service by 2025.



© INCAT CROWTHER



Höegh Autoliners

## Höegh Aurora

Höegh Autoliners' *Höegh Aurora*, the world's largest pure car and truck carrier (PCTC) vessel, is the first of 12 Aurora Class vessels being built by **China Merchants Heavy Industry**. Featuring 14 decks—including five liftable decks—the ship can carry up to 9,100 CEU. With enhanced decks and ramps, the vessel is designed to carry electric vehicles on all decks, and will be very flexible for most cargo. Designed by **Del-tamarin**, the ships will be powered multi-fuel engines from **MAN ES** that can run on marine gas oil (MGO) and liquefied natural gas (LNG). They also have **DNV's** ammonia ready and methanol ready notations.

Following the 12 Aurora Class vessels currently on order, Höegh Autoliners has an option to build another four vessels (vessels 13-16), as well as slot reservations for additional four vessels (vessels 17-20).



# In the Shipyard

## Green Ship Designs & Deliveries



Conrad Shipyard

### Conrad Shipyard: First-of-class US Navy Barge

Conrad Shipyard held a ceremony recognizing the first-of-class yard, repair, berthing, messing vessel (YRBM) it is building for the U.S. Navy. Scheduled for delivery to the Navy later this year, YRBM-57 will serve as pierside living accommodations for U.S. Navy sailors. It is capable of berthing 199 mixed gender personnel, messing for 300 personnel and includes spaces for medical offices, classrooms, workspaces, laundry rooms, storerooms and lounge areas. Conrad senior vice president and Director Dan Conrad said, "When Conrad was awarded this contract in 2022, my father and Conrad Chairman, Johnny Conrad, told our management team that this was our opportunity to give back to American sailors who sail into harm's way. He framed it as a thank you for their service and sacrifice."

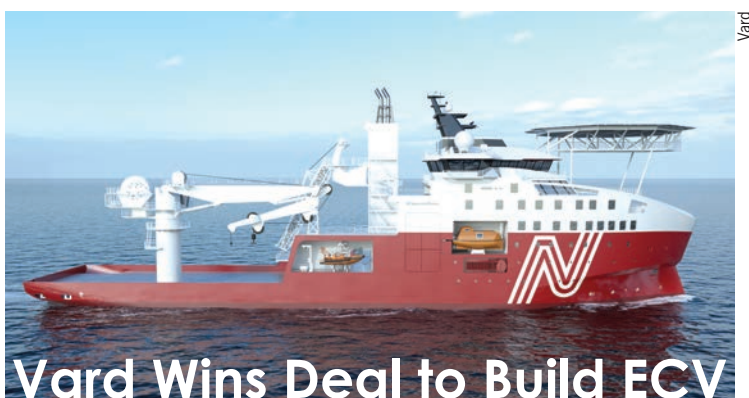

Vard

### Vard Wins Deal to Build ECV

Vard signed a contract with Wind Energy Construction for the design and construction of a new energy construction vessel (ECV), securing an option, too, for one additional vessel. Wind Energy Construction is a Norwegian company partly owned by the founders and owners of Norwind Offshore. The most recent order marks the sixth vessel the owners of Norwind Offshore have contracted with Vard since October 2021. The five previous vessels were CSOVs. The parties have also agreed on an option for one additional vessel which can be declared later in 2024. The ECV will be of VARD 3 11 design, tailor-made for the offshore wind and subsea market, including inspection, maintenance and repair of pipes, and construction and installation of infrastructure above and below sea level. It will be 111.5 m long with a 22.4-m beam. This is the first construction vessel Vard will build with a motion-compensated gangway (walk-to-work) permanently installed. The vessel will be built, outfitted, commissioned and delivered from Vard Vung Tau in Vietnam and is scheduled for delivery in the second quarter of 2027.

## ESG inks deal to Build Four Escort Tugs for Saltchuk

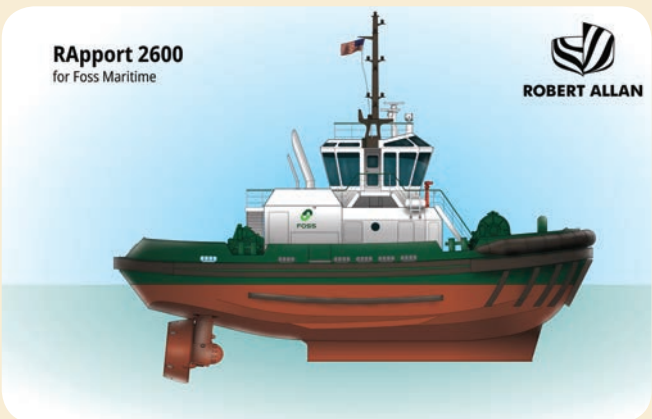

RAL

Eastern Shipbuilding Group (ESG) won a contract to build four new escort tugs for Saltchuk Marine. The vessels will be built at ESG's Allanton and Port St. Joe facilities, with delivery expected in 2026. Over the past 20 years, ESG

has delivered 35 ship assist tugs to customers. This contract marks the beginning of Saltchuk Marine's long-term fleet renewal project, with the new tugs set to support West Coast port operations and comply with EPA Tier 4 and California Air Resources Board (CARB) environmental requirements.

Main Particulars	
Owner .....	Saltchuk
Delivery .....	2026
Type .....	Ship Assist/Escort Tug
Length, o.a. ....	84 ft. (excluding fenders)
Breadth, molded .....	42 ft.
Depth, moulded .....	14 ft.
Draft, navigation .....	18.6 ft.
Accommodation for .....	8 persons
Speed, ahead .....	12 knots
Bollard Pull, minimum .....	95 Short Tons (86.2 MT)
Main Engines .....	Caterpillar 3516E, EPA Tier 4, 3500 hp (2610 kW) @ 1,800 rpm
Thrusters .....	Schottel RudderPropeller SRP 510
Hawser Winch .....	Markey Machine DEPGF-52, 75HP, Single Drum Class II Winch



# Time is Ticking Toward BWM D-2 Discharge Standards Deadline

*In the maritime world, time waits for no one—especially when it comes to regulatory compliance. The Ballast Water Management (BWM) Convention's D-2 standards deadline is fast approaching, with a cutoff date of September 8, 2024. Compliance with BWM is not merely a recommendation; it has become a necessity.*

**By Andrew Marshall, CEO Ecochlor**

**T**he D-2 standards outline the maximum allowable levels of viable organisms in ballast water discharge, including specific harmful microbes. We should remember that these regulations are not just bureaucratic red tape but are important measures designed to protect our oceans from invasive species. The approaching D-2 standards deadline marks a significant turning point that has been a long time coming. If you haven't yet installed a Ballast Water Management System (BWMS), now is the time to act.

If your current system isn't performing as expected, consider a replacement. The risks are considerable now that we are at the end-game in the BWM trial period.

Purchasing a BWMS use to be an afterthought, with decisions mainly driven by cost and type approval. However, feedback from shipowners has highlighted the significant impact BWMS can have on port entry and exit efficiency. Issues such as poor performance, lack of service support, complex operating systems and recordkeeping for the crew, and Port State Control (PSC) in-

spection failures can lead to delays and long-term compliance problems. These issues are far from petty annoyances; they present real financial and operational risks. Thus, if you are having difficulties with your BWMS, rather than spending a lot of money trying to fix an old system, consider replacing it with a new one. This choice can present a window of opportunity for shipowners—a chance to rectify past choices and make better, more informed decisions based on regulations that didn't exist when the initial decision was made.



Currently, we are witnessing a shift towards even more stringent environmental regulations. Notably, the International Maritime Organization (IMO) MARPOL VI objectives and the newly introduced Carbon Intensity Indicator (CII) ratings, not to mention the European Union Emissions Trading System (EU ETS) reporting requirements, are all compelling shipowners to adopt cleaner operating practices.

These initiatives aim to reduce carbon emissions from ships and are requiring major investments in greener technologies. Operational adjustments for energy efficiency and potential ship modifications are not just options but important steps forward. It's easy to dismiss small actions as insignificant, but I believe that this couldn't be further from the truth. With pressing climate challenges, every step counts!

Ballast water management and decarbonization are often seen as separate issues, but they are, in fact, closely interconnected. Addressing one problem often aids in resolving the other, creating a mutually dependent relationship between compliance and sustainability. Actions like route or weather optimization, slow steaming, hull air lubrication and carbon capture and storage systems, as well as investing in energy-efficient BWMS technology can collectively have a significant impact on a ship's emissions.

While the initial expense of decarbonizing ships or retrofitting a BWMS can be prohibitive, this way of thinking underestimates the long-term benefits. A ship's energy efficiency is indispensable in today's market and having a BWMS that operates with a minimal carbon footprint that aligns with the new decarbonization goals would be invaluable.

Over a vessel's lifetime, the efficiencies and savings achieved can often outweigh any initial investment. In short, it's a classic case of spending money to save money.

The clock is ticking towards the September 8, 2024 deadline for the BWMS D-2 discharge standards. Shipowners must act now and choose their BWMS wisely to ensure compliance. Investing in a reliable BWMS not only aligns with impending regulatory requirements but also enhances your crew's experience and ensures smooth port entries and exits. For those seeking answers, it's important to know that reliable, tried-and-tested solutions are out there.

If you don't know what they are, I'd be happy to assist you!

Don't wait until it's too late—make an informed decision today to secure a sustainable and efficient future for your fleet.

# Set a Course for your Career

## Become a NOAA professional mariner!

[marinerhiring.noaa.gov](https://marinerhiring.noaa.gov)  
1-833-SAIL-USA (724-5872)

*Sail  
with NOAA's  
fleet of research  
and survey ships!*

# BUYER'S DIRECTORY

THIS DIRECTORY SECTION IS AN EDITORIAL FEATURE PUBLISHED IN EVERY ISSUE FOR THE CONVENIENCE OF THE READERS OF MARITIME REPORTER. A QUICK-REFERENCE READERS' GUIDE, IT INCLUDES THE NAMES AND ADDRESSES OF THE WORLD'S LEADING MANUFACTURERS AND SUPPLIERS OF ALL TYPES OF MARINE MACHINERY, EQUIPMENT, SUPPLIES AND SERVICES. A LISTING IS PROVIDED, AT NO COST FOR ONE YEAR IN ALL ISSUES, ONLY TO COMPANIES WITH CONTINUING ADVERTISING PROGRAMS IN THIS PUBLICATION, WHETHER AN ADVERTISEMENT APPEARS IN EVERY ISSUE OR NOT. BECAUSE IT IS AN EDITORIAL SERVICE, UNPAID AND NOT PART OF THE ADVERTISERS CONTRACT, MR ASSUMES NO RESPONSIBILITY FOR ERRORS. IF YOU ARE INTERESTED IN HAVING YOUR COMPANY LISTED IN THIS BUYER'S DIRECTORY SECTION, CONTACT MARK O'MALLEY AT [OMALLEY@MARINELINK.COM](mailto:OMALLEY@MARINELINK.COM)

## ANCHORS & CHAINS

Anchor Marine & Supply, INC., 6545 Lindbergh Houston, Texas 77087, tel:(713) 644-1183, fax:(713) 644-1185, david@anchormarinehouston.com

## ENGINE ORDER TELEGRAPH

Prime Mover Controls, 3600 Gilmore Way Burnaby B.C. V5G 4R8 Canada, tel:604 433-4644, fax:604 433-5570, Michael.Combs@pmc-controls.com

## INERTIAL SENSING SYSTEMS

Silicon Sensing Systems Ltd, Clifton Road Southway, Plymouth, Devon PL6 6DE United Kingdom, UK, tel:+44 (0) 1752 723330, sales@siliconsensing.com

## INTERCOM SYSTEMS

David Clark Headset Communication Systems, 360 Franklin Street, Worcester, MA 01615, USA, tel:+1 (508) 751-5800, sales@DavidClark.com contact: Sales Department, www.DavidClark.com

## MARINE SENSORS

Falmouth Scientific, Inc., PO Box 326, Pocasset, MA, USA, tel:(508) 564-7640, fhogg@falmouth.com contact: Fred Hegg, Falmouth.com

## MEMS MOTION SENSING

Silicon Sensing Systems Ltd, Clifton Road Southway, Plymouth, Devon PL6 6DE United Kingdom, UK, tel:+44 (0) 1752 723330, sales@siliconsensing.com

## METEOROLOGICAL INSTRUMENTS

R.M. Young Company, 2801 Aero Park Dr., Traverse City, MI, USA, tel:231-946-3980, fax:231-946-4772, vsherman@youngusa.com

## MILITARY SONAR SYSTEMS

Massa Products Corporation, 280 Lincoln Street, Hingham, MA 02043-1796, tel:(781) 749-4800, nel@massa.com

## NAVIGATION AND CONTROLS

Prime Mover Controls, 3600 Gilmore Way Burnaby B.C. V5G 4R8 Canada, tel:604 433-4644, fax:604 433-5570, Michael.Combs@pmc-controls.com

## OCEANIC TRANSDUCERS

Massa Products Corporation, 280 Lincoln Street, Hingham, MA 02043-1796, tel:(781) 749-4800, nel@massa.com contact: Nick Landis

## REMOTE OPERATIONS TECHNOLOGY

Harvest Technology Group Limited, 7 Turner Avenue, Technology Park Bentley WA 6102, Australia, tel:61 429498089, alice.lewis@harvest-tech.com.au

## REMOTELY OPERATED VEHICLES

Harvest Technology Group, 7 Turner Avenue Technology Park Bentley, Australia 6102, tel:61 429498089, alice.lewis@harvest-tech.com.au

## SENSORS

Silicon Sensing Systems Ltd, Clifton Road Southway, Plymouth, Devon PL6 6DE United Kingdom, UK, tel:+44 (0) 1752 723330, sales@siliconsensing.com, www.siliconsensing.com

## SONAR TRANSDUCERS

Massa Products Corporation, 280 Lincoln Street, Hingham, MA 02043-1796, tel:(781) 749-4800, nel@massa.com

## UNDERWATER SONAR SENSORS

Massa Products Corporation, 280 Lincoln Street, Hingham, MA 02043-1796, tel:(781) 749-4800, nel@massa.com

## VESSEL BUILDING: RESEARCH, PASSENGER, CATAMARAN, PATROL AND SURVEY

All American Marine, 1010 Hilton Ave., Bellingham, WA, USA, tel:(360) 647-7602, Sales@AllAmericanMarine.com contact: Daniel Zech, AllAmericanMarine.com



THE INDUSTRY'S  
ULTIMATE  
ADVERTISING  
PLATFORM



- MarineLink.com
- OEDigital.com
- MarineTechnologyNews.com
- MaritimeProfessional.com
- MarineElectronics.com
- AOGDigital.com
- MaritimePropulsion.com
- MaritimeJobs.com

Drive audience and build brand awareness with New Wave Media's family of websites. Reach diverse audiences around the world with curated multiplatform marketing initiatives.

[WWW.NEWWAVEMEDIA.COM](http://WWW.NEWWAVEMEDIA.COM)



**MAXIMIZE YOUR POTENTIAL.**



**Find your new career at:  
MaritimeJobs.com**

Contact Kathleen Hickey to learn more: [k.hickey@marinelink.com](mailto:k.hickey@marinelink.com)

# MARKETPLACE

Professional

[www.MaritimeProfessional.com](http://www.MaritimeProfessional.com)

**GILBERT ASSOCIATES, INC.**  
**Naval Architects  
 and Marine Engineers**



100 Grossman Dr. Suite 205  
 Braintree, MA 02184  
 T: (781) 740-8193 • F: (781) 740-8197  
 E-mail: JGilbert@jwgainc.com  
[www.jwgainc.com](http://www.jwgainc.com)

**HEGER DRY DOCK INC.**  
 Marine Structural Engineers



Engineering for all types of drydocks

- Floating Drydock Design
- Caisson Gate Design
- Consultation (SME)
- Inspections/Certifications
- US Navy MIL-STD FCR
- Mooring System Designs
- Trolley System Designs
- Accident Investigations
- Drydocking Seminars

77 Main St., Suite 9,  
 Hopkinton, MA 01748  
 +1 (508) 429-1800  
[www.hegerdrydock.com](http://www.hegerdrydock.com)



**Herbert Engineering Corp.**

**SHIP DESIGN &  
 ENGINEERING SERVICES**

*Innovation • Analysis*

- Optimization • BWTS
- Post - 2020 Fuel
- Safety • Efficiency
- Environmental Performance

510-814-9700 | [www.herbert.com](http://www.herbert.com)



**INTELATUS**  
 GLOBAL PARTNERS

**OFFSHORE WIND MARKET INTELLIGENCE**

Get all the information you need to access this growing multi-billion dollar market today!  
[WWW.INTELATUS.COM](http://WWW.INTELATUS.COM)



Download the all new Maritime GlobalNews App from *Maritime Reporter*. All the relevant industry news at your fingertips.

Products & Services

[www.MaritimeEquipment.com](http://www.MaritimeEquipment.com)

**SIMPLE. RUGGED. RELIABLE.**

**KIENE Cylinder Pressure Indicators for measuring diesel engine firing pressures...**

- Easy to use - simple and reliable
- Reduce maintenance costs.
- Improve engine availability.
- Use to balance cylinders.
- Pinpoint engine Problems.
- Optimize fuel consumption.
- Fits any standard indicator valve.
- Recommended and used by major engine builders
- Minimal investment to monitor engine condition.



**Contact us now for more information.**

**KIENE** DIESEL ACCESSORIES, INC.  
 Phone: 1-800-264-5950  
 Fax: 630-543-5953  
[www.kienediesel.com](http://www.kienediesel.com)  
 E-mail: [info@kienediesel.com](mailto:info@kienediesel.com)

**Maritime Today**  
**E-News Service**

In business, time is of the essence.



Stay up to date with the latest NEWS & INFORMATION...

...from the industry's leading source; providing you with daily updates on the subjects that pertain to your business.

[www.marinelink.com](http://www.marinelink.com)

**RHOTHETA RADIO DIRECTION FINDERS**

DETECT • LOCATE • FIND



RT-300  
 TWO BAND  
 VHF AM-FM  
 TIMEZERO COMPATIBLE

+1 (954) 495-8700  
[rhotheint.com/marine](http://rhotheint.com/marine)

**RHO** International Inc  
*The Leader in DF*  
**THETA**

**MARITIME PROPULSION**



**Powering the Maritime Industry**

Maritime Propulsion is the largest online database for marine power & propulsion equipment - the fastest way to find engine reports, specs, suppliers and exclusive articles on industry developments.

[www.maritimepropulsion.com](http://www.maritimepropulsion.com)



# MARKETPLACE

## Products & Services

[www.MaritimeEquipment.com](http://www.MaritimeEquipment.com)

### HYDRAULIC NOISE, SHOCK AND VIBRATION SUPPRESSOR

Noise, Shock, Vibration & Pulsation in Quiet, Smooth Flow Out



Three Stage Noise & Pulsation in Reduction Chamber



#### QUALITY NACOL ACCUMULATORS

- Forged shells, no welds
- Long Lasting, No Seam, Pleated Bladders
- We stock 1/5 pint to 15 gallons in Chicago
- Sizes available to 40 gallons



WILKES & MCLEAN, LTD.

(877) 534-6445

[www.wilkesandmclean.com](http://www.wilkesandmclean.com)

[info@wilkesandmclean.com](mailto:info@wilkesandmclean.com)

## BOLLARD

MARINE GENERATORS

Powering the fleet for 60 years!

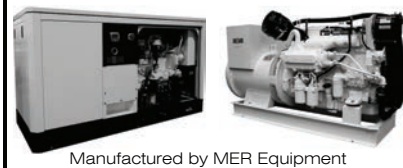

Manufactured by MER Equipment

(206) 286-1817

[www.merequipment.com](http://www.merequipment.com)



### Modular Exhaust System



Up to 70% lighter & 50% less labor cost

754-715-0818

[Info@e4powerllc.com](mailto:Info@e4powerllc.com)

**MARITIME REPORTER**  
AND  
ENGINEERING NEWS

**SUBSCRIBE NOW**

Log on to the [MarineLink.com](http://MarineLink.com) and register to receive your copy online or in print today!

Join the industry's #1 LinkedIn group



**THE MARITIME NETWORK**

<http://bit.do/MaritimeNetwork>

**REMOVE**  
paint, rust, scale & barnacles  
from steel ships



attach to your grinder

[www.swirloff.com](http://www.swirloff.com)

800.823.4670

## Vessels, Barges & Real Estate for Sale/Rent

List your maritime real estate here!  
Contact us today: +1 561-732-4368



Are you wasting money publications with unverifiable circulations numbers?  
It's Time To Audit Your Media Buy.

Insist on a  audit

# ADVERTISER INDEX

Page	Advertiser	Website	Phone#
23	.Advanced Mechanical Enterprises	.www.AMEsolutions.com	.(954) 764-2678
31	.Air Products and Chemicals, Inc.	.www.airproducts.com	.Please visit us online
53	.Anchor Maine & Supply, Inc.	.www.anchormarinehouston.com	.(800) 233-8014
66	.Breakbulk Americas 2024	.www.americas.breakbulk.com	.Please visit us online
27	.Carver Pump	.www.carverpump.com	.(563) 263-3410
11	.Chris-Marine AB	.www.chris-marine.com	.Please visit us online
15	.Cimolai Technology S.P.A.	.www.cimolaitotechnology.com	.011 39 049 0404 539
57	.Creative Systems, Inc.	.www.ghsport.com	.(360) 385-6212
43	.Detyens Shipyards, Inc.	.www.detyens.com	.(843) 308-8000
27	.E4 Power LLC	.www.e4powerllc.com	.(754) 715-0818
37	.Ebac Systems	.www.ebacusa.com	.(757) 873-6800
7	.Ecochlor	.www.ecochlor.com	.(978) 298-1463
5,18	.Greensea IQ	.www.greenseaiq.com	.Please visit us online
59	.Hougen Inc.	.www.hougen.com	.(800) 426-7818
25	.International Registries, Inc.	.www.register-iri.com	.(703) 620-4880
C2	.MAN Energy Solutions SE	.www.man-es.com	.Please visit us online
69	.MMC International	.www.mmcintl.com	.(516) 239-7339
75	.NOAA/Eastern Region Acquisition Division	.http://marinerhiring.noaa.gov	.Please visit us online
13	.Omnithruster	.www.omnithruster.com	.(330) 963-6310
C4	.R.W. Fernstrum & Company	.www.fernstrum.com	.(906) 863-5553
3	.Regal Rexnord Corporation	.www.marine.regalrexnord.com	.(608) 364-8800
17	.Resolve Marine Group	.www.resolvemarine.com	.(954) 764-8700
61	.SMM Hamburg 2024	.www.smm-hamburg.com/	.Please visit us online
1	.Survitec Group	.www.survitecgroup.com	.Please visit us online
C3	.Total LubMarine	.www.lubmarine.totalenergies.com	.Please visit us online
9	.Wabtec Corporation	.www.wabteccorp.com/marine-solutions	.Please visit us online

**Connect with colleagues around the world by  
joining the industry's largest LinkedIn Group.**

**228,000 members**



**<http://www.linkedin.com/group/44626>**

*The listings above are an editorial service provided for the convenience of our readers.  
If you are an advertiser and would like to update or modify any of the above information, please contact: [productionmanager@marinelink.com](mailto:productionmanager@marinelink.com)*





**Lubmarine**

Supporting  
**Operational  
Excellence**

**Together  
we go further**

At Lubmarine, our commitment to customers runs deep. Our trusted experts are dedicated to delivering cutting-edge marine lubrication solutions and services that empower your fleet to navigate with confidence and optimize every voyage.

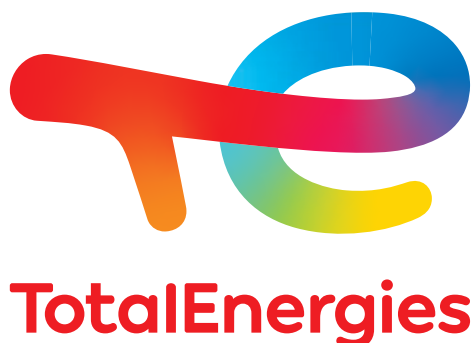

Visit Lubmarine at SMM  
Hall A3 Booth 304





# OUR HIGH SILVER CONTENT IS THE INDUSTRY GOLD STANDARD

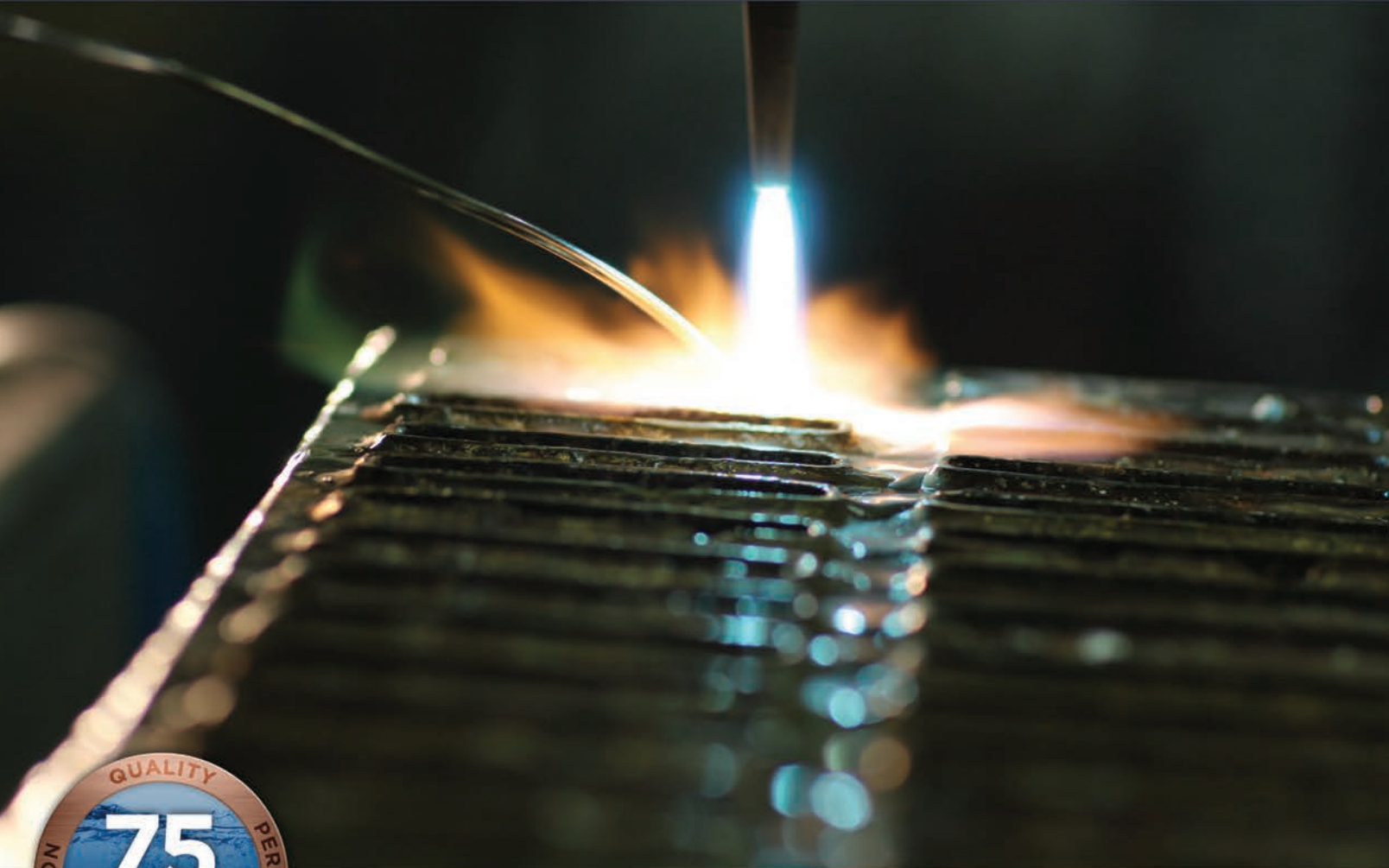

75 years as the World's #1 Keel Cooler, Boxcooler & Pillow Plate

GRIDCOOLER®  
Keel Cooler



By using 56% silver in every brazed joint, our Gridcooler® Keel Coolers hold more structural integrity and shock absorbant flexibility than our competitors- displaying a committment to quality in every joint. Between our Fernstrum Gridcooler Keel Cooler, Weka Boxcooler and Omega Pillow Plate, we offer customers a range of highly innovative solutions and promise the best in customer service. Call or visit our website for a custom quote.



fernstrum.com  
906.863.5553

**FERNSTRUM**®  
R.W. Fernstrum & Company