

# MARITIME REPORTER AND ENGINEERING NEWS

[www.marineink.com](http://www.marineink.com)

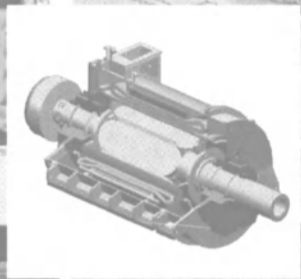

September 2002

# the marine technology edition

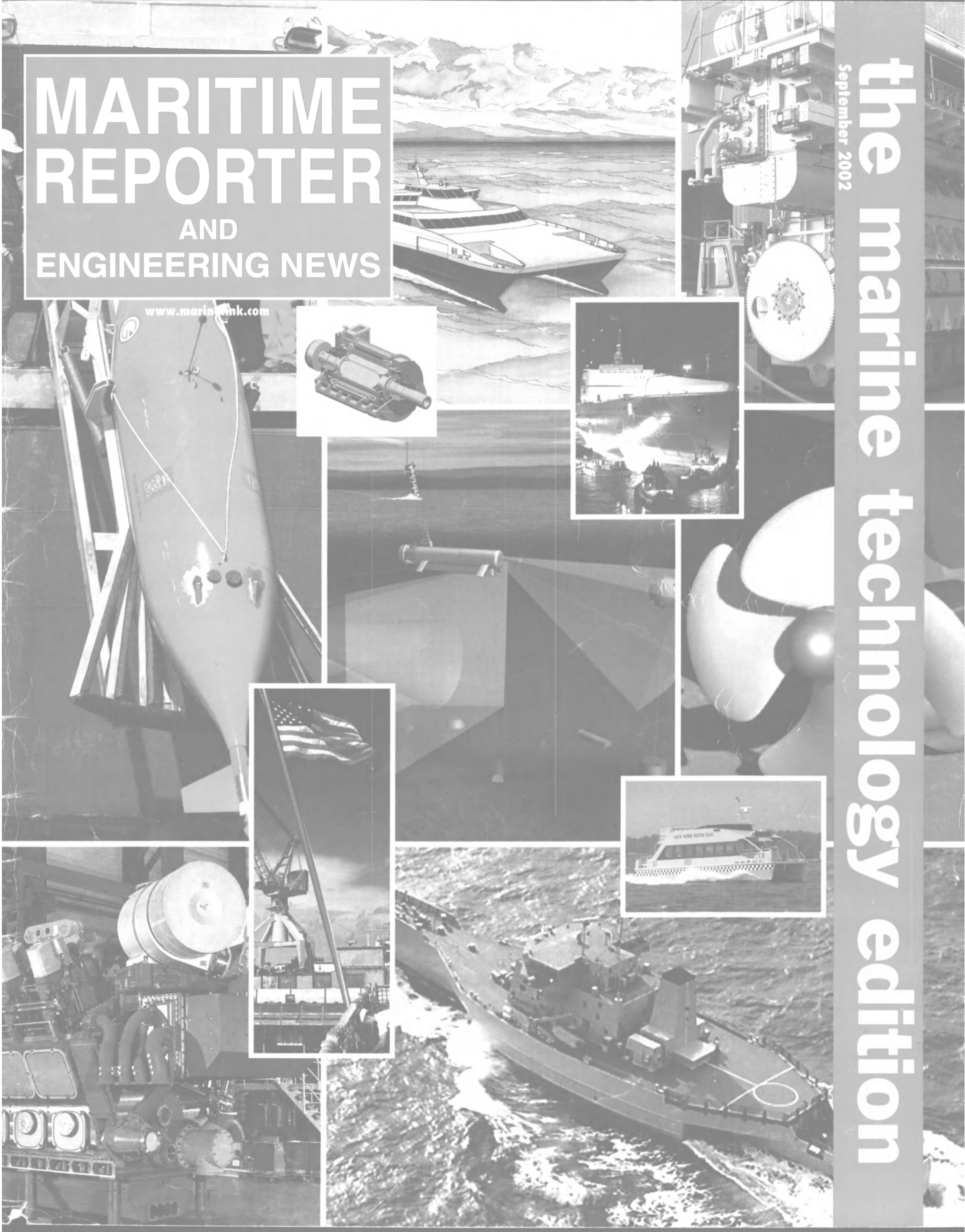

# WHY THE MARINE INDUSTRY IS STEERING TO CRAFT.

The word is out on the water-front. Yachts, tugs, ferries and work boats, they're all saying the same thing – Craft Bearings are the most reliable bearings for marine propulsion shafting, as well as conveyors and fans.

Engineers and maintenance hands love the ease of installation and at-sea repair capability. Captains and owners love the reduced downtime between repairs and the resulting improvements to the bottom line.

Simply put, our American-made Split Roller Bearings are built to last longer than other bearings. Craft Split Roller Bearings give you reliability and accessibility backed by exceptional customer service and technical support!

**Count on Craft to supply your next bearing order.**

- Standard base-to-center height
- Metric, special applications and custom bearings available
- Bore sizes from 1-7/16" to 32", same day shipment up to 12"
- Available in ductile iron and **NEW** stainless steel series
- Complete technical support
- The only split bearing Lloyds Register Type Approved
- Rapid response to larger sizes and special orders
- Craft bearings are directly interchangeable with foreign split bearings
- Made in USA

Circle 220 on Reader Service Card or visit [www.maritimereporterinfo.com](http://www.maritimereporterinfo.com)

**CRAFT**  
ENGINEERED TO MAKE YOUR JOB EASIER  
**Bearing Company, Inc.**



5000 Chestnut Avenue, Newport News, VA 23605  
PHONE: 757-247-6000 FAX: 757-247-6300  
EMAIL: [info@craftbearing.com](mailto:info@craftbearing.com)  
[www.craftbearing.com](http://www.craftbearing.com)

# MARINE ENGINEERING TRAINING

The United States Merchant Marine Academy (USMMA) at Kings Point, New York is one of the five federal service academies and the America's premier maritime institution. Along with the undergraduate program, USMMA offers the most extensive maritime and transportation continuing education program in the United States. Most courses are one to two-weeks in duration.

We teach over 35 Marine Engineering courses and over 100 other courses in Nautical Science, Maritime Business, and Intermodal Transportation. Our instructor staff includes outstanding USMMA faculty, guest lecturers, and industrial experts. "Hands-on" lab exercises compliment classroom lecture where we use the Academy's 22 magnificent engineering laboratories and waterfront vessels. In addition to regularly scheduled courses, we can also tailor programs to meet specific company or organization needs.



**FOR MORE INFORMATION, PLEASE  
CONTACT:**

**USMMA Global Maritime and  
Transportation School  
Samuels Hall  
300 Steamboat Road  
Kings Point NY 11024-1699**

**Phone: 516.773.5149  
Fax: 516.773.5353  
E-mail: frangoss@usmma.edu  
Internet:  
www.usmma.edu/gmats**



## Marine Engineering Training

(Over 35 Engineering Programs such as:)

5 Week Diesel Propulsion Systems

\*\*\*USCG Approved Crossover Course, good for 75 sea days\*\*\*

Repair Techniques for Slow/Medium Speed Diesels

Shipboard Electronic Control Systems

Basic and Advanced Welding/Pipefitting

Basic and Advanced Machine Shop

Auxiliary Systems for Marine Engineers

Sulzer Control Systems

Fundamentals of Diesel Engines

Pump Operation, Maintenance and Troubleshooting

Marine Diesel Surveyor

Marine Refrigeration

\*\*\*Certified under the new Environmental Protection Agency\*\*\*

Marine Engineering Economics

Ship Maintenance and Repair

Basic and Advanced Alignment Solutions

Autocad 2000

Vessel Activation for Strategic Sealift

Programmable Logic Controllers

**\*\*\*CUSTOMIZED TRAINING PROGRAMS  
ALSO AVAILABLE !!!**

UNITED STATES MERCHANT MARINE ACADEMY  
GLOBAL MARITIME AND TRANSPORTATION SCHOOL

***Vision: To be a world leader in providing professional maritime  
education and training***

# MARITIME REPORTER AND ENGINEERING NEWS

**NEW YORK**  
118 E. 25th St., New York, NY 10010  
Tel: (212) 477-6700; Fax: (212) 254-6271  
e-mail: mren@marinelink.com • Web: Internet: www.marinelink.com

**FLORIDA**  
215 NW 3rd St., Boynton Beach, FL 33435

## Associate Publisher

Gregory R. Trauthwein • trauthwein@marinelink.com

## EDITORIAL

### Managing Editor

Regina P. Ciardiello • ciardiello@marinelink.com

### Assistant Editor

Jennifer Rabulon • rabulan@marinelink.com

### Technical Editor

David Tinsley

### Editorial Consultant

James R. McCaul, president, international Maritime Associates

## MARKETING

### Marketing Manager

Richard Grable • grable@marinelink.com  
Tel: (561) 732-1659; Fax: (561) 732-6984

## PRODUCTION

### Production Manager

Michael Lowe • lowe@marinelink.com

### Asst. Production Manager

Oksana Martemy • martemy@marinelink.com

## CIRCULATION

### Circulation Manager

Dale L. Barnett • barnett@marinelink.com

## ADVERTISING SALES

### Vice President of Sales

Lucia M. Annunziata • annunziata@marinelink.com

### National Sales Manager

Rob Howard • howard@marinelink.com  
Tel: (561) 732-4368; Fax: (561) 732-6984

### North American Sales Manager

Brett W. Keil • bkeil@marinelink.com  
Tel: (561) 732-1185; Fax: (561) 732-8414

### Director, New Business Development

Jean Vertucci • vertucci@marinelink.com

### Manager, Information Services

Tina Angelino • angelino@marinelink.com

### Accounting Manager

Angelia Rivera • arivera@marinelink.com

### Classified Sales

Tel: (212) 477-6700

## PUBLISHERS

John E. O'Malley  
John C. O'Malley • jomalley@marinelink.com

## Chief Financial Officer

Al Adinolfi

## International Sales Operations

### Managing Director, International Sales

TONY STEIN

12, Braehead, Bo'ness, West Lothian EH51 0BZ, Scotland, U.K.  
Tel: +44 (0) 1506 822240; Fax: +44 (0) 1506 828085

### CHARLES E. KEIL, Vice President, International Operations

215 NW Third Street, Boynton Beach, FL 33435  
Tel: +561-732-0312; Fax: +561-732-8063  
24-hr Tel/Fax: +561-998-0313; Mobile Tel: +561-716-0338  
e-mail: ckeil@marinelink.com

### China

TED GREEN

Zhejiang International Advertising Corp.  
596 Tiyuchang Road, Hangzhou, Zhejiang 31007  
Tel: +86 571 5150937; Fax: +86 571 5150444

### Germany/Switzerland

TONY STEIN

12, Braehead, Bo'ness, West Lothian EH51 0BZ, Scotland, U.K.  
Tel: +44 (0) 1506 822240; Fax: +44 (0) 1506 828085

### Japan

KATSUHIRO ISHII

Ace Media Service Inc., 12-6, 4-chome, Nishiike,  
Adachi-ku, Tokyo 121, Japan  
Tel: +81 3 5691 3335; Fax: +81 3 5691 3336

### Korea

JO, YOUNG SANG

Business Communications, Inc., Kwangwhomun PO. Box 1916, Seoul, Korea  
Tel: +82 2 739 7840; Fax: +82 2 732 3662

### Scandinavia

STEPHAN R. G. ORN/LEON SCHULZ

AB Stephan R. G. Orn, Box 184, S-271 24 Ystod, Sweden  
Tel: +46 411-184 00; Fax: +46 411 105 31

### Spain

JOSE LUIS SEVA

Via Exclusivas S.L., C/ Viriato, 69 SC, 28010, Madrid, Spain  
Tel: +34 91 448 9136; Fax: +34 91 446 0214

## Contents

### 18 Crewing & Maritime Security

Increasing security means increased burden on crew and owners.

— By Dennis L. Bryant,

Senior Maritime Counsel, Haight Gardner Holland & Knight

### 22 Three Hulls = One Ship

RV Triton — helps to evolve warship design.

### SMM/Germany Report

34 Precision Ship-Handling Writ Large: Alan Haig-Brown offers an insider's look at German Harbor Pilot ops.

40 Modern Maid-of-All Work: David Tinsley reports on Rickmers-Linie's new Superflex Heavy multipurpose container carrier.

43 A German Ferry for All Harbors: The Hanseatic Port of Hamburg has never shied from innovation.

### Marine Propulsion Annual

50 More Power, Less Space ... Such is the claim of American Superconductor and its innovative HTS motor, a powerplant that has turned the heads of the U.S. Navy.

52 Fuel Cell Technology ... Millennium Cell Inc. has teamed with Seaworthy Systems to bring its fuel cell technology to the maritime world.

### 60 The New Hunter/Gatherers

The concept that a naval task force operating in littoral waters can detect underwater mines using remotely controlled unmanned vehicles is on the verge of being realized.

— by Frans Jurgens

### 68 Halter is Back for More

With a new owner and renewed vigor, Halter Marine will emerge from Chapter 11 with the urge to pick up where it left off.

### 78 Schubert Part II

U.S. Maritime Administrator William G. Schubert, in the second of a two-part interview with H. Clayton Cook, Jr., shares his views on invigorating the U.S. maritime industry.

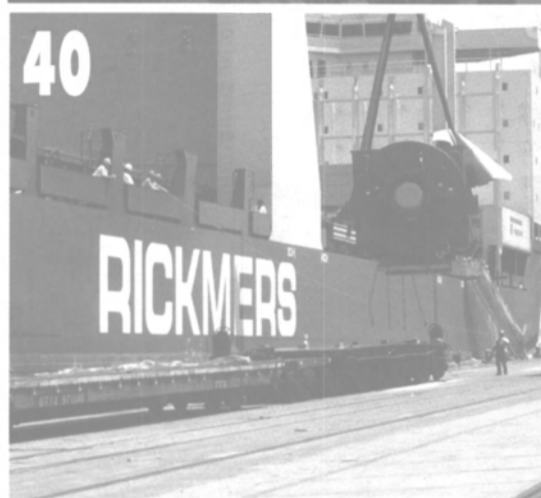

## EVAC—6,500 marine applications, 48 reps worldwide

### Standard design. Standard components.

#### EVAC toilets:

- Use only 3 pints per flush
- Is not affected by the pitch and roll of the vessel
- Use small 1.5" - 2" diameter piping
- Allow flexibility in pipe routing and vertical lifts
- Reduce sewage volume by 90%
- Reduce holding tank size by 80%
- Eliminate toilet vents
- Reduce material and labor costs
- Cut topside piping weight

#### ORCA® IIA sewage treatment systems\*

- Offer a choice of 6 standard pre-engineered models
- Have improved level floats
- Have a new chlorine pump
- Have a redesigned pressure relief valve
- Are fully automatic
- Use microprocessors for control, monitoring
- Are compact, lightweight
- Are easy to operate and maintain
- Operate in fresh, salt or brackish water
- Available with automatic chlorine generators

\* Large ORCAs are modular

USCGIMO and EC certified.  
ISO 9001 registered.  
On-staff marine engineers for technical assistance.

EVAC, developing vacuum technology in the U.S. since 1979.



For a FREE color brochure including dimensions, technical specifications and enhanced system features, contact EVAC or an EVAC representative.



ENVIROVAC INC.  
1260 Turret Dr.  
Rockford, IL 61115 U.S.A.  
888-GET-EVAC (438-3822) • 815-654-8300  
Fax: 815-654-8306  
E-mail: marine@evac.com  
Web site: www.envirovacinc.com

Circle 229 on Reader Service Card or visit [www.maritimereporterinfo.com](http://www.maritimereporterinfo.com)

# Thinking Repower?

Think **SERIES 60**.<sup>®</sup>  
The Profitable Solution.

Ask about the  
Core Buyback Offer  
and factory  
discounts



- Three-year limited warranty
- Low overall operating expense
- Low smoke for clean operation
- Extended service coverage options
- Smooth, quiet operation for crew comfort
- Outstanding acceleration, exceptional fuel economy



For more information contact your  
**mtu** or Detroit Diesel Distributor or [www.detroitdiesel.com](http://www.detroitdiesel.com)

**DETROIT DIESEL**



Circle 224 on Reader Service Card or visit [www.mar.timerepairerinfo.com](http://www.mar.timerepairerinfo.com)

## The Index

Directory of companies given editorial coverage in this edition of *Maritime Reporter & Engineering News*.

A&P Group	66	Derecktor Shipyards	16	Lindenau Shipyard	49	Port Authority of NY/NJ	87
ABB Ltd.	66	Detroit Diesel	16	Lloyd's List Events	66	PT Apexindo Pratama Duta	64
Alaska Tanker Co.	14	Disch Construction	21	Lockheed Martin	77	QinetiQ	22
Alfa-Laval	48	DNV	24	Lockheed Martin (NE&SS)	60	Raytheon	8, 62
ALSTOM	73	Electric Boat	8, 33, 64	MacGregor	66	Reederei F. Laeisz GmbH	36
American Classic Voyages	10	Elliott Bay Design Group	27	MAN B&W	37, 56	Regulateurs Europa	52H
American Superconductor	49	Entech Assoc.	87	MarAd	10, 78	Reintjes	21, 87
AmSteel	14	Federal Highway Administration	82	Marco Shipyard	14	Resurgence Software	48
Andros Maritime	59	Foran	30	Marine Transportation System	85	Rice	87
APL	37	Frank Mohn	46	Markey	14	Rickmers-Linie	40
Aquamaster	44	Friede Goldman Halter	68	Mauritius Polic	14	RINA	17
Atlantas Marine	66	Furmanite	66	McNulty Offshore	77	Rolls-Royce	16, 44
Atlantec	30	Gaz de France	73	Metropolitan Stevedore	89	Ross Engineering	77
Bach Dang	56	General Electric	52G, 52H	Mi-Jack Products	47	Royal Caribbean	52G
Bath Iron Works	26	Germanischer Lloyd	40, 49	Millennium Cell	52	RTK Marine	14
Baylor University	21	Ha Long Shipyards	56	Mitsubishi Heavy Industries	30	Rutter Technologies	48
Becker Marine	48	HADAG	43	MOL (America)	87	Saltchuk Resources	15
Beele Engineering	48, 76	Haight Gardner Holland & Knight	18	Montco Offshore	21	Schottel	46, 52H
Bender Shipbuilding & Repair	87	Haldor Topsoe	59	MWH	48, 66	Sea Boats	21
Benjn. R. Vickers & Sons	58	Halter Marine	15, 68	N.Y. Water Taxi	16	Seaworthy Systems	52
Blohm+Voss	37	Hamburg Nautical Institute	37	NASA	73	SENECO	21, 89
Blount-Barker Shipbuilding	16	Hanjin Heavy Industries	36	NASSCO	15, 78	Ship Repair & Conversion 2002	66
Bollinger Shipyards	21	Hanseatic Port of Hamburg	34, 43	NautiCast	38, 66	Siderise, Ltd.	52G
Bond Instrumentation	66	Hapag-Lloyd	37	Nautilus	21	Siemens Marine	52H
Bremer Vulkan	35	HDW	33	Nigel Gee & Associates	16	Simplex Turbulo	66
British Maritime Technology	66	HTS	50	NOAA	12, 70	SMIT	46
Bukser og Berging	14	ILS-Software	48	Northrop Grumman Corp.	8, 26, 31	SNAME	66
Carnival Corp.	13, 17	IMO	20	Norwegian Cruise Line	10, 13	SOCP	89
Caterpillar	14, 21, 46, 52H, 86	Inmarsat	12	Nupas	30	Southwest Marine	64
Celebrity Cruises	52G, 88	J&L, Inc.	15, 71	Ocean Logistics	48	ST Engineering	70
CMR	52G	Jets Vacuum	46	Oil Mate	46	Star Cruise Group	10
Columbia Shipmanagement	49	Jinling Shipyard	40	Oilsafe	47	STEP Tools	31
Comp Air	48	Jotron	46	P De Beer & Co.	66	STN Atlas	46
Contship	40	JRC	12	P&O Nedlloyd	40, 66	Stolt-Nielsen	59
COSCO Container Line	34	Keppel Corp.	64	Pacific Fisherman Shipyard	86	SUNY Maritime College	88
CP Ships	12, 52H	KMSS	77, 88	Pacific Richfield Marine	64	Survival Inspectorate	66
Crowley Maritime Corp.	14	Kvaerner Philadelphia Shipyard	78	Palmer Johnson	88	TACOM	71
Cummins	44, 62, 87	Kvaerner-Masa Yards	17	Paxman	25	Technip-Coflexip	77
Daewoo Shipbuilding & Engineering	40	L-3 Communications	47, 77	Pikkio Works Oy	17	Titan Maritime	11

**SELF-CLEANING FILTRATION**

Hellan Strainer is a leading manufacturer of filtration products for commercial and military ships throughout the world. ABS, UL, Lloyd's Register and NAVSEA approved. ISO-9001 certified.

Labels in diagram: HPAC, Fuel Compensating, Tube Oil Cooler, Reifer Condenser, CIWS Cooler, Reverse Osmosis, Distiller Plant, Fire Main, Fuel Transfer, CIWS Cooler, Aegis Cooler, Steering Gear Cooler, Stern Tube Seal, LPAC, Sea Chest Suction, SSGTO SW, Starting Air Cooler, A/C Plant.

THE HELLAN STRAINER COMPANY  
www.hellanstrainer.com  
Ph: (888) 4-HELLAN Fx: (216) 206-4242

Circle 239 on Reader Service Card or visit [www.maritimereporterinfo.com](http://www.maritimereporterinfo.com)

**ANCHORS**

**ANCHOR MARINE**

LARGEST INVENTORY OF NEW & USED IN THE U.S.A.

ALL TYPE ANCHORS & CHAIN ABS, LLOYDS GRADE 2, 3, K-4 CHAIN & FITTINGS

FAX: 713/644-1185  
WATTS: 800/233-8014  
PHONE: 713/644-1183

P.O. BOX 58645  
HOUSTON, TX 77258

sales@anchormarinehouston.com  
www.anchormarinehouston.com

Circle 207 on Reader Service Card or visit [www.maritimereporterinfo.com](http://www.maritimereporterinfo.com)

**Everywhere you need us!**

**PAN-STEEL™ System for Harsh Environments**

- WAVE-TY for high tension grip on non resilient objects
- Nylon 11 Coated Tie for the strength of steel and the protection of nylon
- General Purpose Tie for superior strength, for most bundling applications
- Excellent resistance to temperature extremes, corrosion, weather and UV radiation
- UL, ABS, DNV, Lloyds approved
- Available in 304 and 316 stainless steel, loop tensile strengths from 100–250 lbs.
- Self locking for quick installation, fully rounded edges for extra safety

www.panduit.com/eg

**PANDUIT**  
ELECTRICAL GROUP

PANDUIT® Corp., Tinley Park, IL 60477 • Customer Service: 800-777-3300  
For technical assistance call: 866-405-6659 or email: [tinfo@panduit.com](mailto:tinfo@panduit.com)

Circle 276 on Reader Service Card or visit [www.maritimereporterinfo.com](http://www.maritimereporterinfo.com)

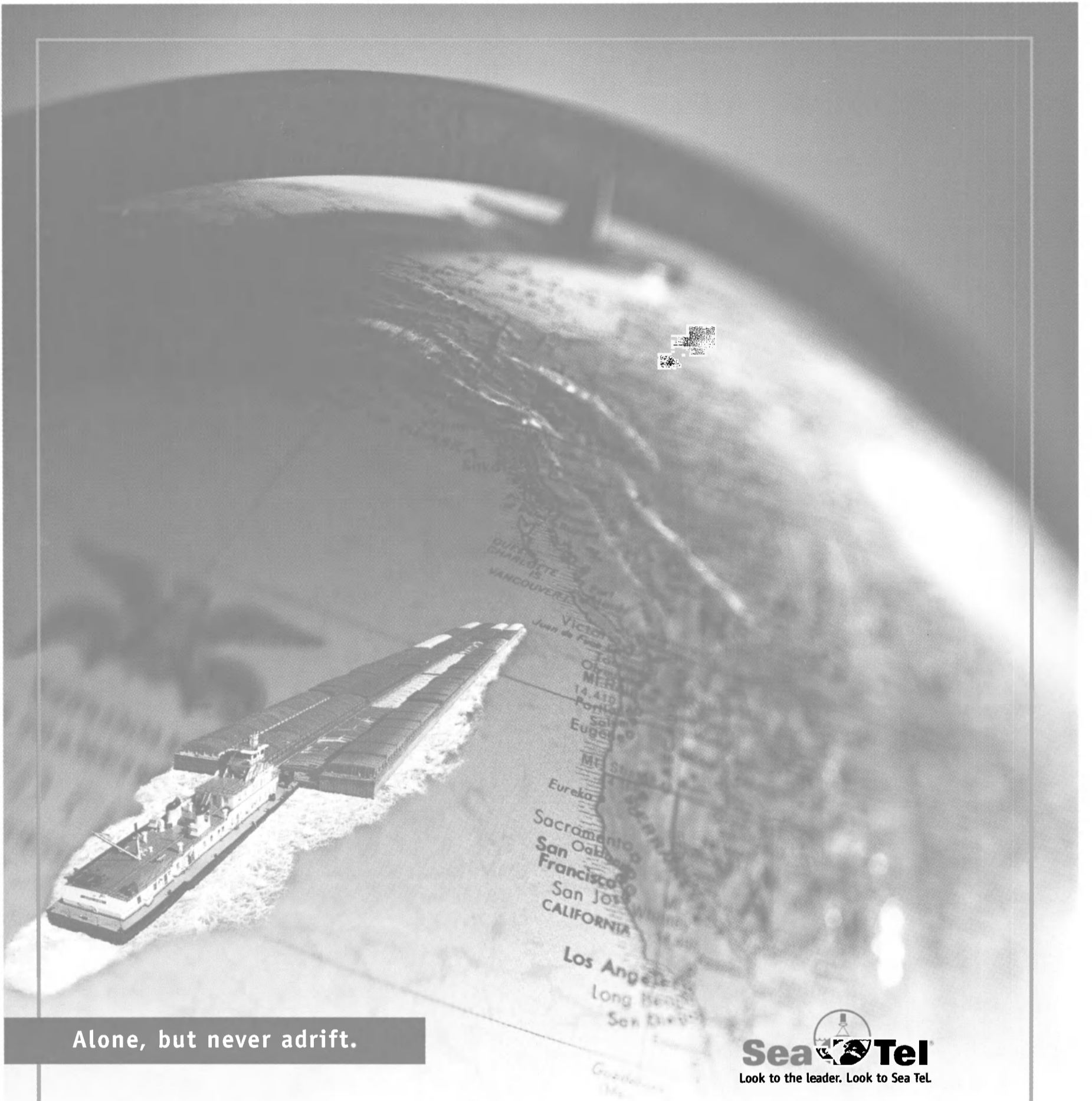

**Alone, but never adrift.**

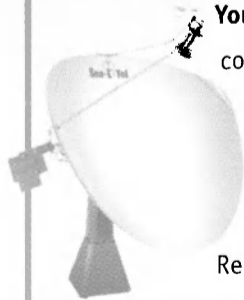

**Your ships are half a world away in nasty conditions. Relax.** You can depend on Sea Tel for reliable, uninterrupted satellite communications at sea. No other company has the depth and breadth of products from TV-at-Sea to mega bandwidth communications. No other company has the technology that allows you to monitor your antenna from halfway around the world. No other company even comes close for worldwide service and support. For more than two decades, twenty thousand plus large system installations prove Sea Tel is the one both navies and commercial fleets trust.

Reliability. Responsiveness. Ruggedness. When you want peace-of-mind inside, make it Sea Tel outside.

Sea Tel, Inc. 925.798.7979

[www.seatel.com](http://www.seatel.com)

Sea Tel Europe 44 (0) 2380 671155

Circle 288 on Reader Service Card or visit [www.maritimereporterinfo.com](http://www.maritimereporterinfo.com)

**A**merican Shipbuilding has, in my opinion, seen its lowest point, during the past year.”

Most of you might naturally assume that this is a recent quote from a high ranking shipyard, government or other informed source regarding the current status of the U.S. marine industry.

Wrong!

This quote is attributed to the opinion of Captain C.A. McAllister, president of the American Bureau of Shipping, published in the January 1, 1928 edition of *Marine Age* magazine. This, and something my five-year-old son said recently, struck a chord within me regarding the challenges facing the U.S. ship and boatbuilding industry. Upon coming home from the beach one hot August day, Shane, upon inspecting his “Adidas” sandals, said, “It says that these were made in Indonesia ... I thought everything was made in China.” From the mouths of babes.

This month I am pleased to present — with the dogged determination of Bastianelli, Brown & Kelly’s H. Clayton Cook Jr., and the much-appreciated cooperation of U.S. Maritime Administrator William G. Schubert — what I feel is one of the most comprehensive and thought provoking assessments of the U.S. Maritime market, current status and future prospects. Mr. Schubert — in the article starting on page 78 — addresses in a straight-forward manner the needs of the industry by vessel niche, as well as complex topics such as financing options and prospects of operating ships profitably

Another traditional maritime powerhouse, Germany, hosts SMM 2002 — arguably the best marine exhibition in the world — later this month in Hamburg. In conjunction with this exhibition, Alan Haig-Brown has recorded in words and photographs — in *On the Road with Charles Kuralt*-esque fashion — an unparalleled insight to German Harbor Pilots operations. Those of you who enjoyed his coverage of a journey down through the Germany country side aboard the 345-ft. Johannes Von Nepomuk with Albrecht Zoller and his wife Roswitha, are sure to enjoy his experience in North Germany, as presented starting on page 34.



*Greg R. Trauthwein*

[www.marinelink.com](http://www.marinelink.com)

[trauthwein@marinelink.com](mailto:trauthwein@marinelink.com)

## On the Cover



This month's cover is a broad rendering of the technological developments highlighted throughout the September 2002 edition, in conjunction with both the SMM Exhibition in Homburg, Germany and the SNAME Exhibition in Boston later this month.

## Also in this Issue

- 8 GAO Affirms DD(x) Contract
- 10 Half-built cruise ship sold to NCL
- 15 NASSCO/TOTE Christen Midnight Sun
- 17 Kvaerner delivers Legend
- 27 Which Hull Shape is Best? by John Waterhouse, PE
- 30 Advancing CAD/CAM Integration
- 38 Nauticast offers AIS solution
- 94 Buyer's Directory
- 96 Advertisers Index
- 97 Classified Ads

Subscriptions: One full year (12 issues) \$18.00 in U.S.; outside of U.S. \$96.00 including postage and handling. For subscription information, contact: Dale Barnett, fax: (212) 254-6271; e-mail: [barnett@marinelink.com](mailto:barnett@marinelink.com)

# MARITIME REPORTER

AND  
ENGINEERING NEWS

ISSN-0025-3448  
USPS-016-750

No. 9

Vol. 64

118 East 25th Street, New York, NY 10010  
tel: (212) 477-6700; fax: (212) 254-6271

Founder: John J. O'Malley 1905 - 1980  
Charles P. O'Malley 1928 - 2000

Maritime Reporter/Engineering News is published monthly by Maritime Activity Reports, Inc. Mailed at Periodicals Postage Rates at Waterbury, CT 06701 and additional mailing offices.

Postmaster send notification (Form 3579) regarding undeliverable magazines to Maritime Reporter/Engineering News, 118 East 25th Street, New York, NY 10010.

Canada Post International Publications Mail Product (Canadian Distribution) Sales Agreement No. 0970700. Printed in U.S.A.

Publishers are not responsible for the safekeeping or return of editorial material.  
© 2002 Maritime Activity Reports, Inc.

All rights reserved. No part of this publication may be reproduced or transmitted in any form or by any means mechanical, photocopying, recording or otherwise without the prior written permission of the publishers.

Member



**Business Publications**  
Audit of Circulation, Inc.

## Other Printed, Internet & Electronic Products

### MarineNews

Published 18 times per year, MarineNews is the leading provider of information and analysis for the North American inland/offshore shallow draft market.

[www.maritimetoday.com](http://www.maritimetoday.com)

Customized e-mail news service delivered twice a day, including the latest contracts, casualties, people & company reports.

[www.maritimejobs.com](http://www.maritimejobs.com)

The marine industry's recruiting & employment resource.

[www.marinelink.com](http://www.marinelink.com)

The Internet's largest marine website, recording more than 270,000 "hits" per month. Daily news, data & statistics, industry directories.

Looking for *service* reliability, we deliver it.  
**ABB Turbochargers**

**ABB**

New York/NJ, Miami, Houston, Seattle/Tacoma, Los Angeles – email: [turbochargers@us.abb.com](mailto:turbochargers@us.abb.com)

Circle 200 on Reader Service Card or visit [www.maritimereporterinfo.com](http://www.maritimereporterinfo.com)





**email and data communications specialists  
for the shipping industry**

**rydex express for performance and value**

An entry-level email solution for ship owners and managers.

**rmx2 the complete communication solution**

Complete ship/shore communication solution offering: LAN support, customized reporting, remote WEB access, message filtering, crew email and AME.

Rydex Canada - Tel: +1 604 279 3400 Fax: +1 604 279 3456  
Rydex UK - Tel: +44 151 709 9917 Fax: +44 151 708 8820  
Rydex Singapore - Tel: +65 6324 5932 Fax: +65 6227 3230  
Sales - sales@rydex.com www.rydex.com

an **inmarsat ventures** company



## News

### GAO Affirms DD(X) Contract to Gold Team

Northrop Grumman Corporation, leader of the DD(X) Gold Team, and Raytheon company, received positive news last month when the General Accounting Office (GAO), decided that an appropriate evaluation process was used when the U.S. Navy selected the

Gold Team to complete the system design for the Navy's 21st century surface combatant, DD(X).

Northrop Grumman's Ship Systems sector will lead the DD(X) system design, engineering prototype development and testing under a \$265 million contract awarded to the Gold Team by the Navy on April 29. The Gold Team

includes Raytheon and more than 30 of the nation's top engineering and maritime industrial companies. The initial design contract has a total value of approximately \$2.9 billion over four years.

Design and technology verification work, which will culminate in the construction of a new family of surface



combatants, includes destroyers, cruisers and littoral combat ships. The transformational technologies developed in the DD(X) program will also be backfitted into today's existing fleet of Aegis-equipped cruisers and destroyers.

Key technologies of DD(X) include developing and testing engineering development models for advanced concepts for the gun system, radar suite, integrated power system, vertical launch system and signature management/reduction.

As electronic systems integrator, Raytheon's Naval & Maritime Integrated Systems (N&MIS) business will be responsible for DD(X) systems engineering, software development and development of combat system equipment. As part of this effort, Raytheon N&MIS will build and test a dual frequency radar suite, an integrated solid-state communication system, a new launcher, an Integrated Undersea Warfare Suite and a multimission total ship computing environment.

*Coming in October MR:*  
A top to bottom review of the U.S. Navy's new "family" of ships.

### GD Awarded \$61M Drydock Contract

Electric Boat, a wholly-owned subsidiary of General Dynamics, has been awarded a U.S. Navy contract worth up to \$61.1 million to maintain and operate the Shippingport drydock at the Naval Submarine Base New London.

The contract covers an initial period of one year, with options for four additional years. Management, operation and preventative maintenance of the Shippingport will be provided on a cost-plus-fixed-fee basis and is worth up to \$34.6 million over the next five years, with \$2.2 million of the total funded in the current fiscal year. The drydocking services associated with this contract will be paid on a firm-fixed-price basis and will be worth up to \$26.4 million during the life of the contract.

The Shippingport (ARDM-4), which is used to lift submarines out of the water for repairs, had previously been operated by Navy personnel, but will now be run by a civilian crew of about 40 Electric Boat employees.

Circle 24 on Reader Service Card  
[www.maritimereporterinfo.com](http://www.maritimereporterinfo.com)

### GLAREGARD BRIDGE WINDOW SUNSCREENS



- Compliance with MSC/Circ.982 & ISM CODE
- Protection of bridge staff from glare
- No reflection on radar screen & other navigation displays
- Type Approved with 7 (seven) year warranty
- Fully retractable / removable
- Reduces the bridge temperature

SOLAR ENGINEERING PARAMETER	Silver %	Gold %	Grey %	Bronze %
Solar Energy Rejected - % of the sun's energy that is rejected by the glazing system	83	82	60	58
Glare reduction - % reduction in visible light passing through the glazing system	92	93	90	83
Visible Light Transmission - % of visible light that passes through the glazing system	7	6	9	15
UV Light Transmission - % of UV light that is transmitted by the glazing system	<3	<3	<3	<3

Martek Marine Blinds Ltd  
Century Business Centre • Manvers Way  
Rotherham • South Yorkshire S63 5DA UK  
Tel: + 44 (0) 1709 300160  
Fax: + 44 (0) 1709 300165  
e-mail: [enquiries@martek-blinds.com](mailto:enquiries@martek-blinds.com)  
[www.martek-marine.com](http://www.martek-marine.com)



Circle 331 on Reader Service Card  
or visit [www.maritimereporterinfo.com](http://www.maritimereporterinfo.com)

### Tough Lights for Rough Seas



When you demand the best lighting — demand lights from

Series M3

Call us today about your lighting needs.

UL 1598A Marine  
UL 844, Class I, Div 2  
USCG  
ABS

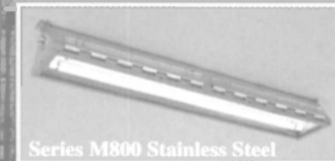

Series M800 Stainless Steel

We wrote the book on toughness.



The L.C. Doane Company  
P.O. Box 975, Essex, CT 06426  
860-767-8295 • Fax: 860-767-1397  
[www.lcdoane.com](http://www.lcdoane.com) • e-mail: [sales@lcdoane.com](mailto:sales@lcdoane.com)

Circle 254 on Reader Service Card  
or visit [www.maritimereporterinfo.com](http://www.maritimereporterinfo.com)

### ShipConstructor Empowering AutoCAD

See us at: SMM Hamburg SNAME/SPS Boston  
Hall of Nations - 7005-1 Booth 44

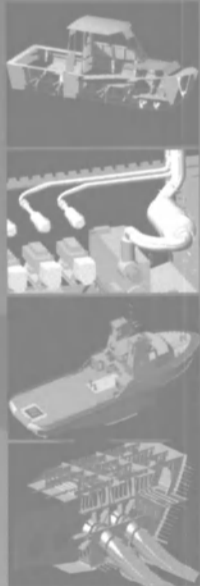

Fairing/Lofting  
Shell/Plate Expansion  
Build Strategy  
Structural Modeling  
Pipe Modeling  
Virtual Reality  
Profile Nesting  
Outfitting  
NO-Processing  
Automatic Nesting  
Revision Tracking  
Production Reports  
3D Assembly Drawings  
3D Spool Drawings  
Inverse Profile Bending  
Pin Jigs  
Profile Plots  
Profile Reports



E-mail: [info@ShipConstructor.com](mailto:info@ShipConstructor.com)  
Web: [www.ShipConstructor.com](http://www.ShipConstructor.com)  
Tel: 1-250-479-3638  
Toll free: 1-888-210-7420  
Fax: 1-250-479-0868

8 Circle 203 on Reader Service Card  
or visit [www.maritimereporterinfo.com](http://www.maritimereporterinfo.com)

Naval architects and salvage engineers:  
How easy do you want it?  
→ Custom wizards are now available in GHS.  
Now you can have it all:  
power, convenience and respectability in the same software package.

# GHS

## General HydroStatics

**Ship Stability and Strength Software**

GHS .....	Full-featured naval architect's system
GHS Load Monitor (GLM) .....	Onboard system
GHS/Salvage .....	Salvor's system
BHS .....	Economy system
BHS/Yacht .....	Yacht designer's system

*Creative Systems, Inc.*  
Creators of GHS™

P.O. Box 1910 Port Townsend, WA 98368 USA  
phone: (360) 385-6212 fax: 385-6213  
email: [sales@ghsport.com](mailto:sales@ghsport.com)  
**[www.ghsport.com/ghs](http://www.ghsport.com/ghs)**  
Making software for naval architects since 1972

Circle 221 on Reader Service Card  
or visit [www.maritimereporterinfo.com](http://www.maritimereporterinfo.com)

***If something goes  
wrong out here...***

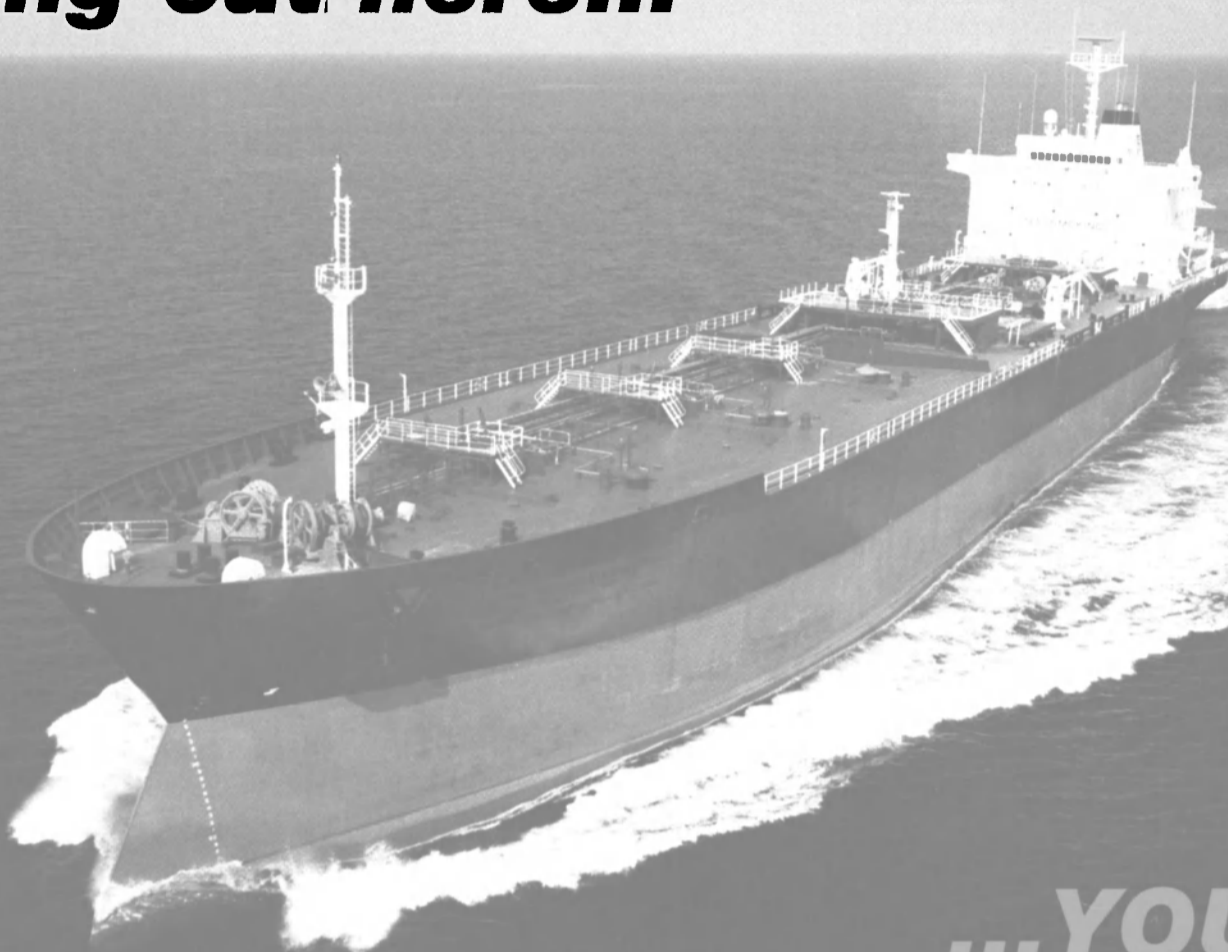

***...YOU CAN'T  
WALK HOME***

The sea respects no one – least of all the weak. She demands respect and receives it from those who live on her. We at Leslie Controls understand this and have made our products with the quality and reliability necessary for marine service.

Leslie Controls produces a complete line of shipboard control products including pneumatic and electric operated control valves, temperature regulators, pressure reducing valves, butterfly valves, ball valves, electro-pneumatic controllers, strainers, stop valves, relief valves, steam water heaters, air and electric whistles, and electrical and pneumatic instruments.



**LESLIE  
CONTROLS, INC.**

A division of CIRCOR International, Inc.

12501 Telecom Drive • Tampa, FL 33637-0903

(800) 439-4485 • Fax: (813) 977-0174

[www.lesliecontrols.com](http://www.lesliecontrols.com)

***Leslie Controls...A tradition at sea.***



Aeroflow  
Control  
Valves

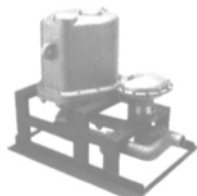

Steam-water  
Heaters



Temperature  
Regulators



PMC-1



Three-Way  
Rotary Valves



Laurence  
Electrically  
Actuated Valves



K-Max  
Rotary  
Control  
Valve

**Quality Products for the Marine Industry**

Circle 255 on Reader Service Card or visit [www.maritimereporterinfo.com](http://www.maritimereporterinfo.com)

## Northrop Grumman Unloads Half-built Project America Ship to NCL

The saga of the now-defunct American Classic Voyages' U.S. Lines has seemingly come to a close with Northrop Grumman Corporation reaching an agreement on August 19 to sell all struc-

tures and material associated with the cruise vessel program at the company's Ship Systems sector to Norwegian Cruise Line.

Under the agreement, Norwegian

Cruise Line will take possession by Sept. 30, 2002 of the nearly half-complete first ship and all associated equipment and materials, as well as material acquired by Northrop Grumman for a

planned second ship. Approximately 350 Ship Systems employees are currently preparing the cruise ship for launching and towing. These ships were to have been known as the first cruise ships to be constructed in the U.S. in more than 30 years.

The company does not expect the sale to impact previously announced financial guidance. In May, the U.S. Maritime Administration (MarAd) conducted an auction for the cruise ship and associated materials, at which time MarAd subsequently directed Northrop Grumman Ship Systems to proceed unilaterally with the disposition of the vessel.

Malaysian-based Star Cruises Group, which is the parent company of NCL, said that the vessel will be operated as part of the Norwegian fleet as a 2,000-guest purpose-built ship for Freestyle Cruising. The yet-to-be-named ship will be delivered in spring of 2004 in time for the summer season.

NCL has contracted with Northrop Grumman Ship Systems (NGSS) to buy all of the materials and equipment and the work performed to date on the two Project America vessels under construction at Northrop's Ingalls shipyard in Mississippi, that were to have been part of the now-defunct United States Lines fleet. The substantially completed hull of the first vessel, plus all of the associated equipment and materials, will be transported to Europe, where work will be completed in a yet to be determined shipyard.

"The acquisition of the 'Project America' assets was prompted by the success of Freestyle Cruising, the tremendous reception we have had to Norwegian Sun and Star, and the need to add ships as soon as possible after the delivery of Norwegian Dawn, our last scheduled new build, in December 2002," said Colin Veitch, president and CEO of NCL.

The original design of the "Project America" ship has been modified and will sail under the NCL brand as the latest addition to the company's revolutionary Freestyle Cruising fleet, which allows passengers to enjoy the benefits of no fixed meal times and no assigned seating in a relaxed atmosphere.

Eighty percent of the staterooms will have an ocean view, with 85 percent of those including private balconies — a total of five decks with private balconies.

Once the completion of the first vessel is under way, NCL will explore the feasibility of completing the second vessel based on the work in progress and materials that have been purchased as part of the deal with NGSS.

**Circle 71 on Reader Service Card**  
[www.maritimereporterinfo.com](http://www.maritimereporterinfo.com)

### YOU'VE KNOWN US FOR QUALITY RIGGING PRODUCTS SINCE 1890



Now more than ever, Skookum signifies value in today's cost-conscious world. Our comprehensive block, fairlead, sheave and alloy forging lines have met the challenges of the most demanding applications around the world. And in the process, we've proudly taken part in the shaping of American history, from salvage operations at Pearl Harbor and construction of the Grand Coulee Dam to San Francisco's BART and the space shuttle.

Whatever your applications, we're committed to serving you with the finest in standard and custom engineered products.

For further information contact your nearest dealer or call us direct.

**Skookum**  
PO Box 280, Hubbard, Oregon 97032  
Telephone 503/651-3175  
1-800/547-8211 FAX 503/651-3409

**SKOOKUM**  **Blocks & Rigging**  
AN ULVEN COMPANY

**Circle 292 on Reader Service Card**  
or visit [www.maritimereporterinfo.com](http://www.maritimereporterinfo.com)

# Wynn

### High Performance Wiper Systems

- Straight line window wipers
- Pantograph window wipers
- Pendulum window wipers
- Clear view screens
- Associated control systems



Wynn Marine Ltd, Wynn House, Lansdown Estate, Cheltenham, GL51 8PL, United Kingdom  
Tel: + 44 (0)1242 232266 Fax: + 44 (0)1242 231131, email: sales@wynn.co.uk, website: www.wynn.co.uk

**Circle 314 on Reader Service Card**  
or visit [www.maritimereporterinfo.com](http://www.maritimereporterinfo.com)

## Tension Load Indicating Links and Shackles

### sales and rental

### Cabled and wireless systems



**0-300 TONS CAPACITY**  
custom specials to 5000 tons



Water Weights Inc

for further details call:  
USA toll free: 1-888-998-3787  
tel: 1-909-626-8316  
fax: 1-909-626-8326

[www.waterweights.com](http://www.waterweights.com)

AN IMES GROUP COMPANY  
[www.imesgroup.com](http://www.imesgroup.com)



**Circle 311 on Reader Service Card**  
or visit [www.maritimereporterinfo.com](http://www.maritimereporterinfo.com)

Would you like to know her better?  
Our lifeboats we mean!



OEM licensee/lifeboat manufacturer for Fassmer and Survival Craft

Call us now at  
**(65) 887 5034**

for full details.

Wolong International Pte Ltd  
151, Chin Swee Road, #03-14, Manhattan House, Singapore 119876  
Tel: (65) 887 5034 Fax: (65) 887 5043 Email: wolongintl@pacific.net.sg

Factory: Yuecheng Town, Jiangsu, China



**Circle 230 on Reader Service Card**  
or visit [www.maritimereporterinfo.com](http://www.maritimereporterinfo.com)

## Oil Recovery Project Makes Progress

The U.S. Coast Guard's Marine Safety Office San Francisco Bay, the California Department of Fish and Game Office of Spill Prevention and Response (OSPR) and Titan Maritime, Inc. continue their steady progress on the assessment and oil removal operations from the sunken 468-ft. (142.6-m) cargo ship S.S. Jacob Luckenbach, which sank 50 years ago, 17 miles West of San Francisco.



Despite the challenges and risks involved with the operation, the responders have identified 26 tanks and spaces on the wreck containing about 132,000 gallons of heavy fuel oil. To date, about 12,000 gallons of oil have been recovered. During the assessment, many fuel tanks were found to have badly corroded vent pipes, which allowed oil to slowly leak into the cargo holds. These vents are the primary sources of the pollution that has contaminated shorelines and sea birds over the last few years.

Most of the leaking fuel vents have been sealed, but the process is ongoing. Operations in the forward cargo holds have been especially challenging. Inaccurate ship drawings and piles of cargo have complicated the search for vents in the holds. The 50-year-old cargo has corroded and fused together, forcing divers to chisel through solid walls of material to tunnel access ways to the vents.

The piles of cargo create safety concerns for the divers due to its instability. The recovery team has also had to overcome many challenges, including; diving in 175 ft. of water, 45 degree sea temperatures, poor underwater visibility, and strong bottom currents.

With the assessment and vent sealing phase nearly completed, the responders are using various techniques to remove the oil from the tanks. The oil at 50 degrees resembles that of peanut butter in thickness and is very difficult to pump to the surface. Divers are inserting heat exchangers and injecting steam into the oil to raise the oil's temperature enough to pump. The responders are making good progress refining these techniques or developing new, innovative ways to remove as much oil as possible.

Circle 27 on Reader Service Card  
www.maritimereporterinfo.com

S.S. Jacob Luckenbach, which sank 50 years ago, 17 miles West of San Francisco, has been slowly leaking oil.

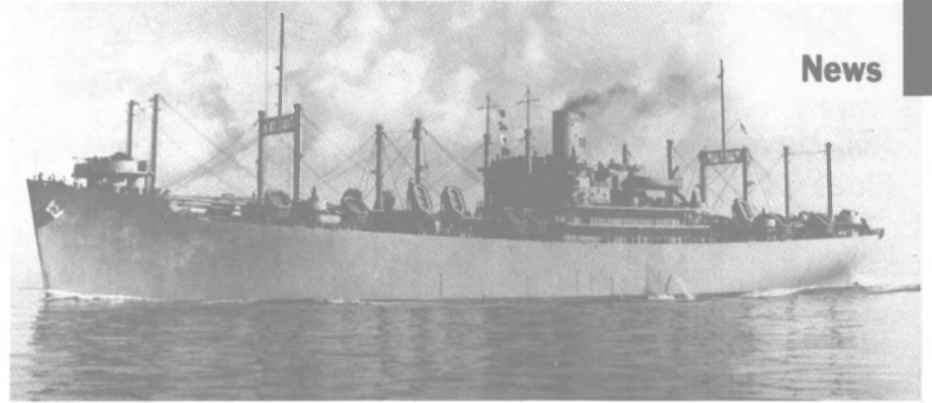

## Foam Filled Marine Fenders Marine Guard™

*The Ultimate Protector for Ships, Harbor Craft, Wharves & Piers.*

- Construction complies with United States Navy and Coast Guard Specifications.
- Core consists of closed-cell, resilient, energy absorbing foam, covered with a protective, seamless polyurethane elastomer skin. Filament nylon tire cord reinforcement is continuously wound in the skin for added strength and durability. Will not mark or scratch vessel hulls.
- Constructed with integral swivel end fittings, internally connected with a heavy duty chain.
- Easy to install with very little maintenance.
- Light weight and extremely buoyant with a lower reaction force than either hard rubber or pneumatic fenders. (Almost 40% higher energy absorption than pneumatic fenders.)

### URETHANE PRODUCTS CORPORATION

**(800) 913-0062**

9076 Rosecrans Avenue  
Bellflower, CA 90706  
Phone (562) 630-4982 • Fax (562) 630-6974

#### Stocking Distributors:

**Waterman Supply Company**  
910 Mahar, Wilmington, CA 90744, U.S.A.  
**1-800-322-3131**  
Tel (310) 522-9698 • Fax (310) 522-1043

**Anchor Marine & Industrial Supply, Inc.**  
6545 Lindbergh, Houston, TX 77087, U.S.A.  
**1-800-233-8014**  
Tel (713) 644-1183 • Fax (713) 644-1185

Circle 307 on Reader Service Card or visit [www.maritimereporterinfo.com](http://www.maritimereporterinfo.com)

**New & Notable**

# Crowley Christens Tug Response

Crowley's latest ship assist and escort tug renamed Response was christened August 2 in Elliott Bay.

**Deicy Mathur**, wife of **Anil Mathur**, President of the Alaska Tanker Company, LLC, performed the christening ceremony aboard Response. A team of Crowley engineers and architects designed the Response, with input from Crowley's ship assist and escort customer, Alaska Tanker Company; the vessel was constructed by Marco Shipyard in Seattle.

Response is a 130 ft. (39.6 m) and 7,200-hp tug able to provide enough indirect force to get most any job done quickly and safely.

Response features twin Voith Schneider 32G II/250 cycloidal propellers, powered by two Caterpillar 3608 DITA engines, and a unique high lift and streamlined hull designed to meet the indirect forces and speed requirements of the tankers operating in Puget Sound. The hull is derived from a design for the tug Boxer and was developed by Bukser og Berging, Norway. It is also equipped with full fire fighting capabilities and can carry 2,800 of foam concentrate.

Measuring 130 x 46 x 25 ft. (39.3 x 14 x 7.6 m), Response is designed to generate direct bollard pull of 150,000 lbs. and indirect forces in excess of 340,000 lbs. at 12 knots, with an anticipated free running speed of 15 knots.

Fitted with a Markey Model DESS-52 High Performance single-drum electric Hawser winch designed



specifically for this vessel, Response's winch will hold 1,000 ft. of 10-in. circumference AmSteel Blue high molecular weight polyethylene line with an average strength of more than one million lbs. This main line will be able to be hauled in at pressures of over twice the bollard pull of the boat's engines, a condition that can occur when escorting tankers at high speed.

For more information on the following companies, circle the corresponding Reader Service Card number:

- Crowley Maritime 1
- Voith Schneider 30
- Caterpillar 31
- Bukser og Berging 32
- Markey 33
- AmSteel 34

## Halmatic Secures Police Order

To satisfy their requirement for four heavy-duty multi-purpose workboats the Mauritius Police have opted for the RTK Marine 29-ft. (9-m) Ramped Logistic Support Boat.

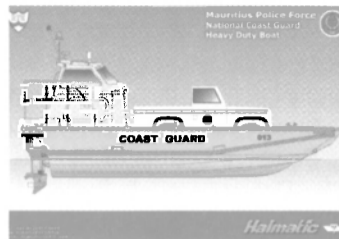

The workboats are a new commercial derivative of the 29-ft. (9-m) Combat Support Boat proven in service with the U.K. Ministry of Defense and feature a raised aft-wheelhouse with a ramped well deck.

Main Particulars	
Length, (o.a.)	29 ft. (8.7m)
Beam	10 ft. (3.2m)
Draft	3.2 ft. (1 m)
Weight	3,450 kg (lightship)
Payload	1,800 kg max

The planing, asymmetrical catamaran hull form is manufactured from GRP and features a high degree of reserve buoyancy to enable the craft to remain afloat when fully swamped. The self-draining well deck features a manually operated bow ramp and is capable of carrying a short wheelbase Land Rover, general cargo or personnel with the modular straddle seating in place.

Power is provided by twin 200-hp outboard motors to give a service speed in excess of 30 knots, the outboards are protected and can be quickly raised to facilitate beach landings.

Circle 54 on Reader Service Card  
[www.maritimereporterinfo.com](http://www.maritimereporterinfo.com)

**TIME** is always an issue...  
but our 24-hour service  
is a **GIVEN.**

**Motor-Services Hugo Stamp, Inc.** provides factory authorized service when you need it most for two and four-stroke engines, and we offer "reconditioned component exchanges."

**MSHS** is unique through its in-house ability to provide integrated turnkey solutions, which include: authorized service and spares for Turbochargers, Boll Filtration Systems, Laser Alignment and rechocking with Epocast 36®, as well as, LEMAG engine analysis equipment.

For more detailed information, call 1-800-622-6747, or visit our website at [www.mshs.com](http://www.mshs.com).

Quality-Assurance  
**ISO 9002**

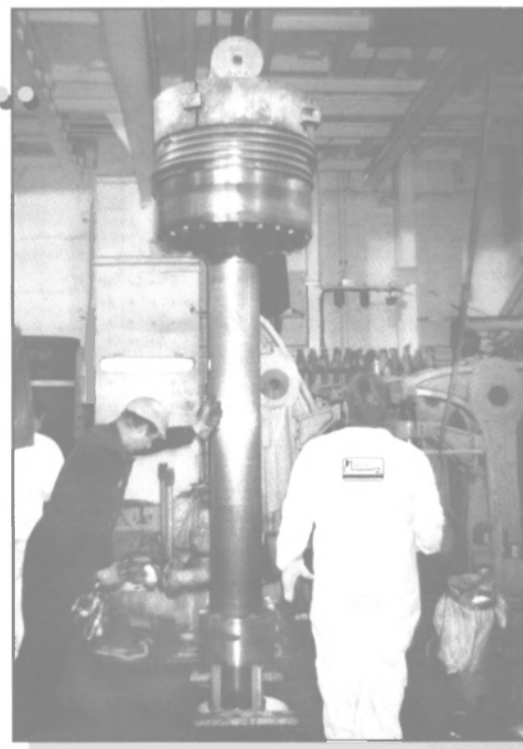

## MOTOR-SERVICES HUGO STAMP, INC.

AUTHORIZED DISTRIBUTORS & SERVICE CENTER

MAN B&W • SULZER • NAPIER • KBB • ABB • LASER ALIGNMENT • BOLL FILTRATION • DEUTZ ENGINE SALES AND SERVICE

Circle 267 on Reader Service Card or visit [www.maritimereporterinfo.com](http://www.maritimereporterinfo.com)

## NASSCO and TOTE Christen Midnight Sun

National Steel and Shipbuilding Company (NASSCO) has joined with Totem Ocean Trailer Express, Inc. (TOTE) to christen M.V. Midnight Sun, the first commercial dry cargo vessel to be built in the U.S. in 10 years. Midnight Sun is the first of two new Orca-class trailer-ships being built by NASSCO for TOTE's service from Tacoma, Wash., to Anchorage, Alaska.

Lynn Garvey, wife of Mike Garvey, Chairman of the Board of TOTE's parent



TOTE's 840-ft. (256-m) M.V. Midnight Sun was floated out at NASSCO in August.

company, Saltchuk Resources, Inc., and Lily Stevens, the daughter of Senator Ted Stevens (R-Alaska), were the ship's sponsors, christening M.V. Midnight Sun with ceremonial bottles of champagne. Senator Stevens, who is serving in his seventh term in the U.S. Senate, was the keynote speaker at the event. M.V. Midnight Sun, and its sister ship, M.V. North Star, are 840 x 118-ft. (256 x 35.9-m) RoRo cargo ships offering the option to carry trailers as large as 53 ft. The ships' cargo can be loaded and discharged in nine hours, with the speed and efficiency of this process being an important competitive advantage for TOTE.

M. V. Midnight Sun and M. V. North Star have already received several prestigious awards for their environmentally sensitive design. These include the States/British Columbia Oil Spill Task Force Legacy Award for 2000, the Alaska Department of Environmental Conservation Commissioner's 2000 Pollution Prevention Award, and the Biennial William M. Benkert Foundation 2002 Environmental Excellence Bronze Award. With Midnight Sun scheduled for delivery in early 2003, North Star will be christened on March 15, 2003, for a summer 2003 delivery.

Circle 16 on Reader Service Card  
www.maritimereporterinfo.com

## Halter Launches First J&L Barge

Halter Marine has launched Capella (meaning the brightest star in the constellation Auriga) an 80,000-barrel tank barge for J&L, Inc. The barge, the first project Halter has undertaken for J&L, was built at Halter's Gulfport, Miss. Yard for an August 30 delivery.

Measuring 332 ft. (101.1 m), with a beam of 74 ft. (22.5 m) and a depth of 25 ft. (7.6 m), the barge is built to U.S. Coast Guard standards under Sub-chapter D, as a tank barge certified to carry Grade A or lower bulk petroleum products. The barge also qualifies to be certified by ABS under the +A1 Oil Tank Barge designation.

The facility, technical, managerial and

manpower assets of the Halter business unit are in the process of being transferred to VT Kinetics. After the closing, which is expected to take place no later than the end of August 2002, the new name of this company will be VT Halter Marine, Inc.

Circle 21 on Reader Service Card  
www.maritimereporterinfo.com

## CHEMICAL CARRIERS



As the result of the merger between the renowned Spanish builders Astilleros Espanoles and Bazan, IZAR is one of the largest shipbuilding groups in the world.

Our mission is to help shipowners match the increasing demands of a competitive shipping market. And we have a wealth of experience in doing so.

IZAR has built some of the most sophisticated chemical carriers for shipowners all over the world.

From chemical parcel arrangements to ships with stainless steel tanks, IZAR has designed and built chemical carriers incorporating the latest technologies.

But also built to meet the strictest safety and environmental regulations, as dictated by the market.

And, most importantly, we are ready to meet any demand.

Let IZAR help build your utopia.



Pº de la Castellana, 55 • 28046 MADRID, Spain • Tel. +34 91 335 84 00 • Fax +34 91 441 50 90 • www.izar.es

Circle 245 on Reader Service Card or visit www.maritimereporterinfo.com

## New & Notable

### "Taxi!?"

New York Water Taxi (NYWT) has accepted the delivery of Mickey Murphy — the first in a series of 53-ft. (16.1-m) passenger ferries constructed by Derektor Shipyards. The bright yellow boats, which sport a black and white checkered trim, they will enhance water-

borne transportation for New York City residents, as well as the millions of tourists that visit the major attractions on the West Side, Lower Manhattan and Downtown Brooklyn Waterfront each year.

Designed by Nigel Gee & Associates, the new Water Taxi is powered by two Detroit Diesel Series 60 engines, pro-

viding 600 hp at 2,100 rpm via Twin Disc gears. It is an all-aluminum catamaran with a low-wake hull and a top speed of 25 knots carrying 54 seated passengers. A bow-



#### Main Particulars

Length, (o.a.)	53 ft. (16.1 m)
Beam, (o.a.)	19 ft. (5.7 m)
Draft	4 ft. (1.2 m)
Engines	2x Detroit Diesel Series 60, 600 bhp
Passenger capacity	75 (max.)

loader type, the vessel allows the passengers to disembark directly from the bow into the cabin located on the main deck. Able to hold 75 passengers, the vessel boasts 54 seats designed by Beurteaux, situated back-to-back so that passengers can enjoy panoramic views of the city during their ride.

**Circle 22 on Reader Service Card**  
[www.maritimereporterinfo.com](http://www.maritimereporterinfo.com)

### Blount Barker Delivers South Ferry Vessel

Last month the 101-ft. (30.7-m) double-ended ferryboat, Sunrise, was delivered to South Ferry, Shelter Island, N.Y., for service along the half-mile crossing of partially protected inland waters between Shelter Island and the South Fork of Long Island.

The 101 x 39 x 11-ft. (30.7 x 11.8 x 3.3-m) ferryboat designed by Dejong & Lebet, Inc. was built to USCG Sub Chapter "T" Rules and Regulations for 150 passengers. The vessel is a tradi-

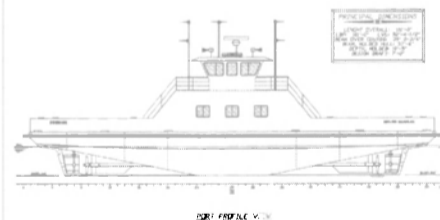

tional car ferry with one open auto deck and enclosed aluminum side cabin with pilothouse.

The Sunrise can carry a maximum of 50 cars or 4 semi-tractor trailers with a maximum load of 240,000 lbs. Sunrise is powered by two Detroit Diesel Series 60 engines producing 400 hp at 1,800 rpm with stand-alone Twin Disc MG-516 gears (4.5:1) for easy access to change Vulcan couplings and Detroit Diesel DDEC controls. The vessel is equipped with two Rolls Royce, ice class, right hand, 54 x 40-in. pitch, four-blade propellers.

**Circle 44 on Reader Service Card**  
[www.maritimereporterinfo.com](http://www.maritimereporterinfo.com)

# Thermax

®

## SALES & DISTRIBUTION

Panel Specialists, Inc. / Thermax NA  
3115 Range Road (P.O. Box 968)  
Temple, TX 76504-1240, USA

Tel: (800) 947-9422 \*USA only  
(254) 774-9800

Fax: (254) 774-7222

Website: [www.panelspec.com](http://www.panelspec.com)

## INTERIOR JOINER WALL PANELS

AROUND THE WORLD ..... NAVAL ARCHITECTS, INTERIOR DECORATORS, MATERIAL SPECIFIERS, SHIP-BUILDERS, JOINERS, AND CABINET MAKERS LOOK TO THERMAX FOR:

- NON-COMBUSTIBLE marine construction boards meeting requirements of SOLAS and IMO resolutions
- Marine fire rated construction boards for bulkheads, joiner panels, walls, double shell, and ceiling
- Marine Regulatory Body Certification (USCG/UL, Canadian Coast Guard, UK DOT, Lloyds, DNV, etc.)
- Excellent core material for marine furniture fabrication
- Environmentally friendly construction material (no fibers, no formaldehydes, nontoxic)
- Technical Support
- Inventory in the USA ready for immediate shipment
- Laminating services available
- Metal profiles for bulkhead systems upon request
- Design, production, and sales of marine products according to requirements of EN DIN ISO 9001:1994

#### Sales

Panel Specialists, Inc. (PSI)  
15006 Shaw Road  
Tampa, FL 33625, USA

Tel: (800) 540-5503 \*USA only

(813) 264-2656

Fax: (813) 264-2507

E-mail: [thermax@erols.com](mailto:thermax@erols.com)

## ISO 9001

Registered and Certified

THERMAX • Subsidiary of ISOVOLTA AG • Austria  
A Constantia Industrieholding A.G. Company

**Circle 304 on Reader Service Card or visit [www.maritimereporterinfo.com](http://www.maritimereporterinfo.com)**

## TRAIN ON THE WORLD'S FIRST DIESEL ELECTRIC SIMULATOR

RTM STAR CENTER®, the premier maritime training center in the Americas, announces the installation of the world's first Full Mission Diesel Electric Simulator. This simulator is based on a design by Kongsberg Maritime Ship Systems with enhanced mechanical and electrical systems enabling it to meet the demanding STCW '95 requirements for Class "A" full mission simulation.

The Full Mission Diesel Electric Simulator will be used to train experienced maritime professionals in the use of proper plant management procedures with an emphasis on safety and human factors.

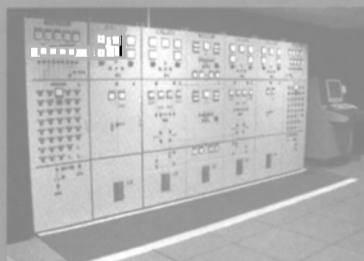

Additionally, the training can be specific in nature for equipment familiarization or more general when used for plant management or Engine Room Resource Management (ERM). The simulator also has the ability to create realistic scenarios requiring troubleshooting and casualty control. This enables real-time assessment of knowledge and proficiency.

If you are interested in finding out more information about RTM STAR Center's state-of-the-art maritime training, please contact one of our customer service representatives.

Ft. Lauderdale & Toledo  
1-800 445-4522

Visit our website: [www.star-center.com](http://www.star-center.com)

RTM **STAR Center**  
SIMULATION, TRAINING, ASSESSMENT & RESEARCH

RTM STAR Center admits students of any race, color, national and ethnic origin or sex

Photos: RTM STAR Center's Diesel Electric Simulator





# Kvaerner Masa-Yards Delivers Carnival Legend

MS Carnival Legend was delivered on August 14 to Carnival Corp. at Kvaerner Masa-Yards' Helsinki shipyard. Legend, which is the fourth cruise ship in a series of new Panamax-Max size cruise ships under construction for Carnival Corporation, is operated by Carnival Cruise Lines and Costa Crociere. The first ship in the series, Costa Atlantica, was delivered in June 2000 - with sister-ships Carnival Spirit and Carnival Pride in 2001.

The vessel carries a total of 2,680 passengers (lower beds: 2,124 passengers) in a total of 1,062 staterooms, and a maximum crew capacity is 961. Measuring 961 ft. (293 m), with a maximum breadth of 127 ft. (38.8 m) (over bridge wings), and a draft at dwl of 25 ft. (7.8 m), the vessel's relative number of outside passenger staterooms and staterooms with balcony is very high; 80 percent of all the staterooms are outside staterooms, and 70 percent of all the staterooms have a balcony. All prefabricated staterooms have been manufactured by Piikkio Works Oy.

Carnival Legend has been built by the yard together with a large number of turn-key and other suppliers. Production began in October 2000, and the assembly of the hull began in the covered new-building dock in April 2001. The vessel was launched in December 2001, after which the cruise ship was transferred to the outfitting quay in front of the yard's outfitting terminal.

Legend has a diesel-electric machinery, consisting of six Wartsila 9L46D diesel engines, with a total power of 62,370 kW, each connected to an alternator producing electricity to the ship's main electric network. The propulsion consists of two azimuthing electric Azipod propulsion units, with a power of 17.6 MW each, as well as three 1.91 MW tunnel thrusters in the bow. The service speed is 22 knots.

Sailing under the Panamanian flag, the

vessel is built according to RINA classification standards, fulfilling RINA's new Green Star environmental standard, consisting of two voluntary RINA class notations, CLEAN SEA and CLEAN AIR, setting strict requirements on the

ship's design and operation, in order to protect the environment and keep the sea and air clean.

Circle 45 on Reader Service Card  
www.maritimereporterinfo.com



## Technological integration makes for a totally comprehensive bridge system

**IBS**  
INTEGRATED  
BRIDGE  
SYSTEM

### Enhanced Safety and Operating Efficiency

IBS is a comprehensive bridge system developed by JRC with three aims: energy conservation, reduced labor demands, and greater safety. A host of unique electronics technologies — in fields ranging from radar, ECDIS and navigation data display to IRCS and INMARSAT — contribute to enhanced safety at sea with significantly lighter demands on the steersman.

#### ① SJD-1206 IRCS Workstation

With this one workstation it is possible to operate a multitude of radio communication facilities. A user-friendly design ensures easy operation by all operators.

#### ② JMA-9800 Color ARPA Radar

This futuristically designed radar unit features a large 29-inch high-definition color CRT display. It enables quick detection of small targets.

#### ③ JAN-3598 ECDIS Total Navigator

This advanced ECDIS system permits fully automatic navigation. It features a large color LCD and abundant functions unique to JRC, including radar video overlay, grounding prevention, NAVTEX data, route safety check, alarm displays and engine data display. The result is greater safety and economy.

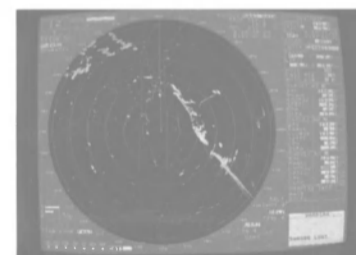

Color Radar

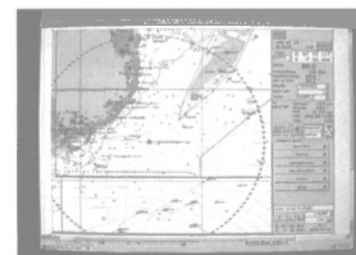

ECDIS

ISO9001, ISO14001 Certified

#### Main Particulars - Carnival Legend

Class .....	RINA
Flag .....	Panama
Length, (o.a.) .....	960 ft. (292.5 m)
Length, (cwl) .....	865 ft. (263.6 m)
Length, (pp) .....	855 ft. (260.6 m)
Breadth, (max.) .....	127 ft. (38.8 m)
Breadth, (dwl) 106 ft. (32.2 m)	
Draft, (dwl) .....	25 ft. (7.8 m)
Draft, (scantling) .....	26 ft. (8 m)
GT ..	85,900, (including balconies, approx. 88,500)
Passenger capacity, lower bed .....	2,124
Passenger capacity, max. ....	2,680
Passenger staterooms, total .....	1,062
Crew capacity .....	961
Speed, service .....	22 knots
Speed, maximum .....	24 knots
Main engines .....	6 x Wartsila 9L46D
Power .....	6 x 10,395 kW/514 rpm
Main generators .....	6 x 14,405 kVA ABB
Propulsion .....	2 x 17.6 MW Azipod

**JRC** Japan Radio Co., Ltd.

Since 1915

Maritime Sales Department:  
1-1, Shimorenjaku 5-chome,  
Mitaka-shi, Tokyo 181-8510, Japan  
Telephone: 81-422-45-9552  
Telefax: 81-422-45-9273  
<http://www.jrc.co.jp/>

Seattle Branch Office:  
1011 SW Klickitat Way Bldg. B,  
Suite 100 Seattle, WA 98134, USA  
Telephone: 1-206-654-5644  
Telefax: 1-206-654-7030

New York Sales Office:  
Suite 208, 2125 Center Avenue,  
Fort Lee, NJ 07024, USA  
Telephone: 1-201-242-1882  
Telefax: 1-201-242-1885

JRC Amsterdam Office:  
Cessnalaan 40-42, 1119 NL,  
Schiphol-Rijk,  
The Netherlands  
Telephone: 31-20-658-0750  
Telefax: 31-20-658-0755

JRC do Brasil Empreendimentos  
Electronics Ltda.  
Av. Almirante Barroso, 63-S/309  
CEP20031-003 Rio de Janeiro, RJ, Brasil  
Telephone: 55-21-220-8121  
Telefax: 55-21-240-6324

Circle 257 on Reader Service Card or visit [www.maritimereporterinfo.com](http://www.maritimereporterinfo.com)

## Government Update

# Crewing and Maritime Security

By Dennis L. Bryant, Senior Maritime Counsel, Haight Gardner Holland & Knight, Washington, D.C.

*In the process of enhancing homeland and maritime security in the United States, the federal government is substantially increasing the burden on the owners, operators, managers, and agents of foreign ships. The heaviest burden, though, is being felt by the individual crewmember.*

### INS Policy

For a short time after the horrific terrorist attacks of September 11, 2002, Immigration and Naturalization Service (INS) officials in some ports (particularly the Port of New York and New Jersey) would not allow non-U.S. crewmembers to land (come ashore) in the United States. This knee-jerk reaction gradually faded and INS processing of foreign crewmembers slowly returned to nearly the pre-9/11 situation.

In March 2002, an incident in Chesapeake, Va. changed the unofficial INS policy. Four Pakistani crewmembers

from the Maltese-flag freighter PROGRESSO sought shore leave. They did not have individual passports and the ship had not obtained a crew list visa. Despite that, the INS officer attending the ship exercised his discretion and, in accordance with the regulations, granted the shore leave request. The crewmembers promptly deserted, hoping for a better life in the United States. The INS Commissioner reacted by immediately recalling the District Director. This action had the intended effect of prompting all other INS District Directors to tighten the procedures for handling foreign ships and their crews.

The unofficial policy that rapidly but unevenly developed within the INS following the PROGRESSO incident was that no work was to begin on any vessel carrying non-U.S. crewmembers unless prior clearance had been received from the INS boarding inspector. On vessels that the Customs Service was not boarding, the gangway was not to be put down unless the INS inspector was present, unless prior approval has been received from the INS inspector. Finally, no visa waivers would be approved. Medical

emergencies or other paroles will be considered only on a case-by-case basis, and then only with the specific approval of an INS supervisor.

Recently, though, even this policy has been tightened. At an increasing number of U.S. ports, the INS is issuing "detain on board" orders, requiring masters to keep on board some or all crewmembers. Allegedly for national security reasons, the INS is refusing to tell masters, agents, and ship owners, operators, and managers the basis of the "detain on board" orders. In many cases, the U.S. Coast Guard, at the request of the local INS office, issues Captain of the Port (COTP) orders requiring masters to hire commercial guard services to man the gangway 24-hours a day while the ship is in port to prevent crewmembers from going ashore. Disputes are now arising between ship owners and ship operators over responsibility for this added cost, which can run as high as \$3,000 per day of the port call.

### Crew List Visas

The U.S. Department of State, in a separate initiative, has drafted a propos-



Dennis L. Bryant is Senior Maritime Counsel at the law firm of Haight Gardner Holland & Knight, Washington, D.C.

al to eliminate crew list visas entirely. This measure, which was submitted on August 6, 2002 for review by the Office of Management and Budget (OMB) and could be placed into effect as early as January 2003, would eliminate U.S. shore leave for all foreign crewmembers except those fortunate enough to have both a valid passport from their country and a current U.S. visa. Many

• Up-to-Date • NOAA Approved • Meets USCG Carriage Requirements • SOLAS Compliant

## Print-on-Demand Nautical Charts

OceanGrafix, an experienced producer of digital print materials, has partnered with the National Oceanic and Atmospheric Administration (NOAA) to provide you with the most up-to-date nautical charts ever offered for commercial and recreational use!

- OceanGrafix charts include the latest Notice to Mariners Corrections, NIMA and NOAA's critical safety updates at the time of printing
- Charts are shipped the same or following business day
- Charts available in water-resistant or laminated versions
- Distinctive graphics and vibrant colors provide easy readability under varying light conditions
- Useful navigational and communication information can be added to chart margins, specified for commercial or recreational mariners
- Over 930 charts are in full production with more being added daily

For a current list of charts, visit [www.nauticalcharts.gov](http://www.nauticalcharts.gov)

To order, visit our website at [www.oceangrafix.com](http://www.oceangrafix.com) for a list of chart agents

Visit us at the  
FISH EXPO and  
WorkBoat Northwest  
booth #2127

CHARTS ON DEMAND  
Patent Pending

OceanGrafix, LLC. 276 E. Fillmore Ave. St. Paul, MN 55107

1-877-56CHART  
[www.oceangrafix.com](http://www.oceangrafix.com)

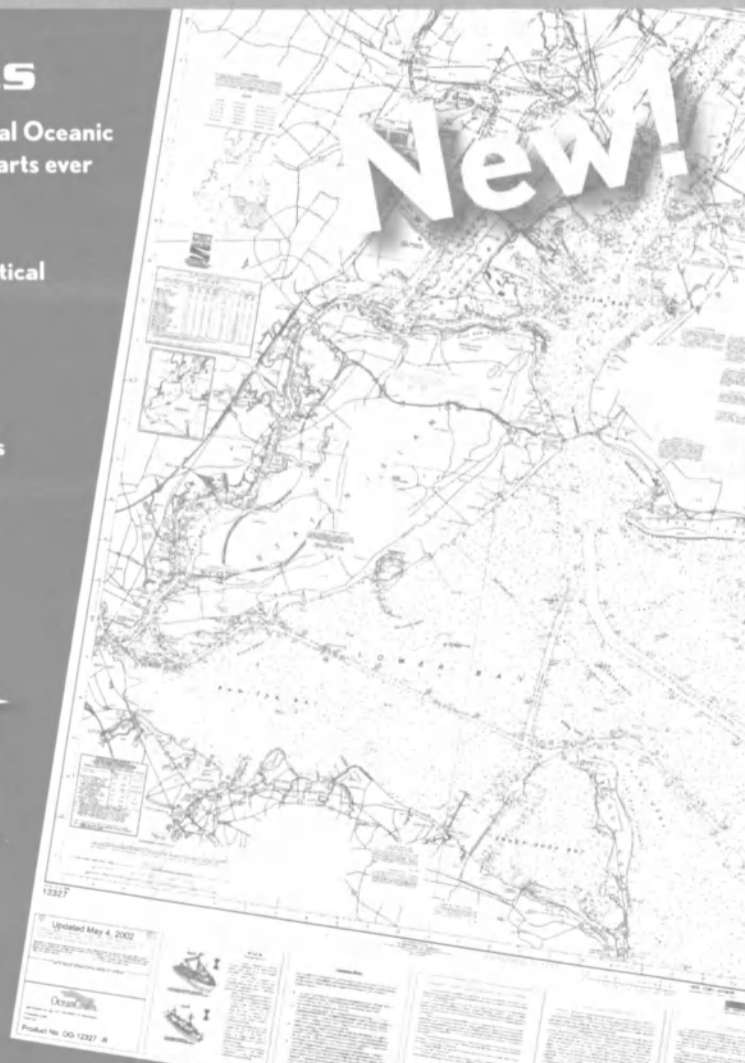

Circle 326 on Reader Service Card or visit [www.maritimereporterinfo.com](http://www.maritimereporterinfo.com)

crewmembers from third world countries lack passports, which traditionally were not required. In addition, it is often difficult for a mariner, who may be sailing for months at a time and who doesn't know future ports of call far in advance, to obtain a U.S. visa. The elimination of the crew list visa will provide a further obstacle to both shore leave and the ability of ship owners, operators, and managers to undertake crew changes while the ship is in a U.S. port.

#### Maritime Identification Credentials

The U.S. Coast Guard has announced that, starting September 6, 2002, it will only accept certain credentials for the purpose of identifying maritime personnel needing to board or disembark from ships and enter or leave waterfront facilities. Acceptable credentials include a military identification card, a federal employee badge, a driver's license or official identification card issued by a Department of Motor Vehicles or a Motor-Vehicle Administration within the U.S., a merchant mariner's document issued by the U.S. Coast Guard, a valid passport, a local law enforcement credential, an identification credential issued by a state or local port authority, and an identification credential issued by a company, union, or trade association. The credential must contain the full name of the individual, include a current photograph of the individual, bear the name of the issuing authority, and be laminated or otherwise secured against tampering.

Unofficially, the individual Captains of the Port (COTPs) are given broad discretion to accept additional credentials that they have determined to be trustworthy, but this will naturally vary from port to port.

Immediately after the terrorist attacks in September 2002, the Secretary of Transportation convened various Direct Action Groups to examine various aspects of transportation security. The Credentialing Direct Action Group (CDAG) has been studying the issue of a National Transportation Workers' Identification Card (TWIC) for all transportation workers and other persons who require access to secure areas at transportation facilities. The Coast Guard policy regarding maritime identification credentials will remain in effect at least until the TWIC process has been finalized and implemented.

#### National Security Entry-Exit Registration System (NSEERS)

On August 12, 2002, Attorney General John Ashcroft announced that on September 11, 2002, the Immigration and Naturalization Service (INS) will commence a pilot program at selected ports of entry called the National Security Entry-Exit Registration System

(NSEERS). The NSEERS Program will be adopted at all U.S. ports of entry (including seaports, airports, and land border crossings) on October 1, 2002. This program, which is intended to "provide greater protection for the United States and help aliens fulfill their responsibilities under the laws of the United States," will require the finger-

printing of some entering foreign visitors and completion of registration forms. Initially, the requirements will be imposed on all nationals of Iran, Iraq, Libya, Sudan, and Syria and on all other nonimmigrants whom the State Department or the INS determines to present an elevated national security risk.

The NSEERS Program relies on regu-

lations that have been on the books for many years, but these regulations have been suspended for decades, as conceded by the Department of Justice.

#### Analysis

The new emphasis on ships' crews raises a host of issues.

The INS is now strictly enforcing reg-

## Government Update

[www.offshorecoms.com](http://www.offshorecoms.com) 2nd ANNUAL

# Offshore 2002 Communications

October 1-3, 2002 - Houston, Texas  
Adams Mark Hotel & Conference Center

OFFSHORE SECURITY  
SUBMARINE TELECOMMUNICATIONS  
SATELLITE WIRELESS  
ACOUSTIC COMMUNICATIONS  
BUOYS & HYBRID NETWORKS  
LEGISLATION & REGULATION  
CABLE INSTALLATION & MAINTENANCE

3 Days!  
Over 100 Exhibit Spaces!  
Register On-Line

Technology Systems Corporation  
PO Box 1096, Palm City, FL 34991  
Tel: (772) 221 7720, Fax: (772) 221 7715  
E-mail: [techsystems@sprintmail.com](mailto:techsystems@sprintmail.com)  
[www.offshorecoms.com](http://www.offshorecoms.com)  
Contact Inger Peterson

GUEST SPEAKERS



CDR Paul Thomas  
USCG



Dr. John Delaney  
Univ. of Washington

**The Communications Event of the Year!**

**Main Sponsor**  
**Schlumberger**

**Corporate Sponsors**  
**tyco**  
Telecommunications  
**PETROCOM**  
**SOLA**  
**CapRock SERVICES CORP.**

**Contributing Sponsors**  
**HARRIS**  
**RigNet**  
**NSW**  
A Corning Cable Systems Company  
**Global Marine**  
**STRATOS**

**Media Sponsors**  
**Ocean News**  
**MarineNews**  
**Offshore Source**  
**MARITIME REPORTER**  
and ENGINEERING NEWS  
**FORUM**

**Organized by**  
Technology Systems Corporation

Circle 273 on Reader Service Card or visit [www.maritimereporterinfo.com](http://www.maritimereporterinfo.com)

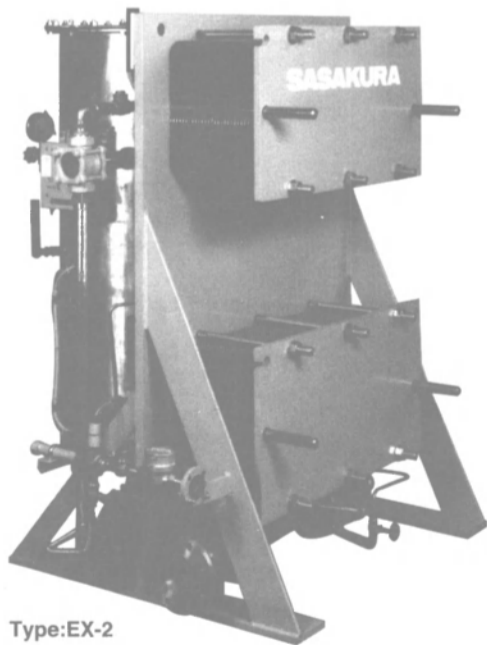

Type: EX-2

Sasakura developed new generation of Plate Type Fresh Water Generator.

# AQUARIO

Capacity range: 3-40t/day

**No Front Cover!!**

The deletion of front cover provides:-

- \* Easier disassembly and reassembly of Plate Heat Exchanger.
- \* No corrosion of Frame, Guide bar, End cover and Bolts & Nuts because they do not contact with seawater.
- \* Minimal installation and maintenance.

Sasakura provides Water Makers of the Submerged Tube Type, Multiple Effect Type, Two Stage & Multi Stage Flash Type, Reverse Osmosis Type and Vacuum Vapor Compression Type for various applications.

**SASAKURA ENGINEERING CO., LTD.**  
7-32, Takejima 4-chome, Nishiyodogawa-ku, Osaka 555-0011, Japan Tel: +81-6-6473-2134 Fax: +81-6-6473-5540  
E-mail: [webmaster@sasakura.co.jp](mailto:webmaster@sasakura.co.jp) website: <http://www.sasakura.co.jp>  
HONG KONG: Sasakura International (H.K.) Co., Ltd. Tel: +852-2850-6139 Fax: +852-2850-5259

Circle 285 on Reader Service Card or visit [www.maritimereporterinfo.com](http://www.maritimereporterinfo.com)

## Government Update

ulations that have not been adhered to in years. The U.S. Coast Guard is preparing to do likewise. Particularly with regard to the newly-reinvigorated INS policy, the question of due process is germane.

The federal government is preparing to implement a transportation worker's

identification card system at the same time that it is negotiating at the International Maritime Organization (IMO) in London and the International Labor Organization (ILO) in Geneva for adoption of a universal mariner's identification card.

Crewmembers are being branded as

threats to U.S. national security, but the individuals affected, the masters, owners, operators, managers, and agents are not being advised of the basis of the allegations. Further, masters are not even being allowed to remove the "suspect" crewmember from the vessel. Such removal would both reduce the alleged

risk to national security and eliminate the requirement for hiring commercial guard service. In many instances, the masters are not even being advised of the reason for the requirement for guard service.

It is questionable whether INS has the authority to require a master to hire a commercial guard service merely because INS has issued a "detain on board" order with regard to a particular crewmember. The pertinent statute merely requires the master to receive and detain the crewmember. The regulations largely repeat the statutory provision. The words 'guard' or 'guard service' appear in neither the statute nor the regulations.

This would not be the first time that INS has overstepped its authority. In the mid-1990s, INS was demanding that sea and air carriers pay detention costs (including the cost of guard services) in cases where a stowaway alleged political asylum. Processing of asylum cases can be lengthy and the detention costs can be high. Various sea and air carriers brought separate actions against INS for recovery of monies expended in accordance with the INS orders. The appellate courts held that INS lacked authority to require the carriers to bear the expense of detention.

On the diplomatic level, the question arises with regard to how the United States Government can engage in meaningful negotiations in an international forum to develop a universal standard for mariners' identification cards when it is actively working on the domestic level to implement a unilateral scheme. Only time will tell whether the two processes will be compatible.

It is presently unclear how many mariners will be caught up in the NSEERS Program and required to be fingerprinted and complete new documentation. If the incidence of "detain on board" orders is any indication, though, the number could be quite high.

### Conclusion

Foreign mariners on foreign ships carry 95 percent of U.S. imports and exports. The U.S. economy would grind to a halt without them and their ships. They have carried U.S. military personnel and U.S. military equipment on a regular basis since at least World War I. While the United States certainly needs to exercise heightened vigilance subsequent to September 11, 2001, the need to "detain on board" large numbers of foreign mariners is less than clear, and certainly has not been explained to those involved or to the public at large. Until and unless a public explanation of the new processes is forthcoming, the U.S. Government will lack moral authority in this regard.



Where can you get  
CYLINDER LINERS & MAJOR PARTS FOR 2-STROKE ENGINE  
in 3 days or less?

No doubt #1 choice, the symbol of the optimization on price, quality, service, and timely delivery.

- Prompt Supply from multi-location stock  
Cyl liner, Cyl cover, Piston crown, Piston skirt,  
Water guide jacket, Fuel injection equipment,  
Piston ring, Stuffing box, Misc parts

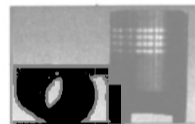

- ★ Our own office/our affiliate office
- Our stock

Extensive stock operated out of Houston, Rotterdam, Shanghai, and Singapore.

Efficient response & professional handling

Guaranteed quality

www.mariso.com

Mariso USA, Inc.  
100 Davidson Avenue,  
Somerset, NJ 08873, USA  
Tel : 1-732-271 2755  
Fax : 1-732-271 2744  
Email: sales.usa@mariso.com

Mariso CO., Ltd  
150 Yangqiaozhai, Xiyang Road  
Heqing, Pudong ND, Shanghai,  
201201, P.R. China  
Tel : 86-21-5897 4077  
Fax : 86-21-5897 7434  
E-mail: sales@mariso.com



ISO9001 certified

Circle 261 on Reader Service Card or visit [www.maritimereporterinfo.com](http://www.maritimereporterinfo.com)

## Maneuver...Propel...Position

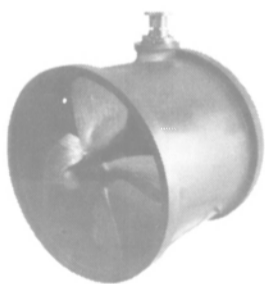

**Tunnel Thrusters**  
100 to 2000 HP

*Harbormaster thrusters and outdrives are found around the world in ships, boats and barges where economical performance is required.*

*For unassisted maneuvering in tight quarters. For easily-moved, deck-mounted propulsion.*

*For critical dynamic positioning.*

*For precision vessel control.*

*Harbormaster Marine products are designed to customer specification and built with utmost care and highest quality.*

*They provide years of durable service and are backed by a reliable support system.*

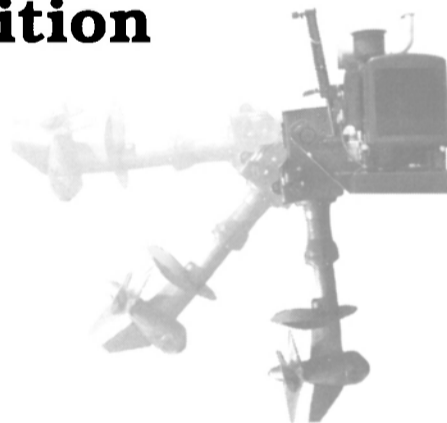

**Outboard and through-the-hull azimuthing drives**  
50 to 1500 HP

### Fast world-wide support!

*If you operate a Harbormaster or Murray & Tregurtha product anywhere in the world, we can provide spare parts and on-site field service. Call us first!*

# Harbormaster

**Harbormaster Marine, Inc.**

**31777 Industrial Road**

**Livonia, MI 48150 USA**

**(734) 425-1080 Fax (734) 425-1850**

Website: <http://www.harbormastermarine.com>

Circle 236 on Reader Service Card or visit [www.maritimereporterinfo.com](http://www.maritimereporterinfo.com)

## President Cuts USCG Funding

On August 13, President Bush hosted the President's Economic Forum at Baylor University in Waco, Texas, bringing together a variety of individuals to discuss the fundamentals of the economy and the President's agenda to increase economic growth for the future.

From the President's Statement at the Economic forum Plenary Session, President Bush indicated that he will refuse to spend a \$5 billion package included in the 2002 Supplemental Appropriations Act for Further Recovery from and Response to Terrorist Attacks on the United States stating, "Congress, for the long-term economic security of America, needs to restrain spending.... And if the Congress won't show spending restraint, I intend to enforce spending restraint."

The President is opposed to several of the individual expenditures in the package, including \$273 million in supplemental funding for the Coast Guard: "But those who wrote the bill designed it so I have to spend all \$5 of the extra billion dollars or spend none of it. That's how they wrote the supplemental. Those are the rules they placed upon my administration. I understand their position, and today they're going to learn mine. We'll spend none of it."

That supplemental funding is now rescinded.

## SENECO To Construct 171-Ft. Hopper Barge

The Southeastern New England Shipbuilding Corporation (SENECO) has signed a major barge contract for construction of a 171-ft. (52.1-m) hopper barge that will have a holding capacity of 2,750 cu. yds. Construction has already begun and is expected to be completed this fall. The barge is being built for Disch Construction of Summit, N.J. who will use the barge to transport dredge spoils.

In addition to an increase in its executive ranks and the announcement of the Disch contract, SENECSO also recently completed a multi-vessel repair contract for Modern Continental, a Boston-based construction company.

SENECSO's repair business is expected to grow even further when the company launches a new dry dock it is building at its Quonset Point, R.I. facility. The new dry dock will allow the company to repair larger vessels and also enable Senesco to launch larger barges, including the 320-ft. (97.5-m), 80,000 barrel double hulled liquid fuel barge being built for Don Church of Sea Boats, Inc.

Circle 12 on Reader Service Card  
www.maritimereporterinfo.com

September, 2002

# Bollinger Builds Next Generation Liftboat

The evolution of liftboats took a giant leap forward when Bollinger Shipyards, Inc., delivered L/B Myrtle, a 137.5-ft. (41.9-m) liftboat to Montco Offshore, Inc., Golden Meadow, La. Equipped with 245-ft. (74.6-m) legs, the self-propelled floating platform has the ability to work in water depths to 180 ft. with a 15-ft. air gap while lifting a total of 850 kips of variable load.

What sets L/B Myrtle apart from other liftboats is that it is equipped with a bow thruster and controllable pitch (CP) propellers for greater maneuverability and pinpoint positioning of the huge legs with oversized pads on the ocean bottom.

The vessel's namesake is in honor of Myrtle Orgeron, mother of Lee Orgeron, and is equipped with 40 x 16-ft. pads (12.1 x 4.8-m), much larger than those on other liftboats, to provide for greater bottom stability and greater deck loads. The L/B Myrtle can also jack with a full pre-load and its pre-load system has quick acting stainless steel dump valves.

It is equipped with three Nautilus cranes with 150, 50 and 25-ton capacities in an innovative configuration. The smaller crane is positioned on the starboard stern so that support vessels can tie-up to the liftboat and offload personnel, cargo, and/or fluids without hindering other work being done by the liftboat. The 150-ton crane has a 110-ft. boom and is equipped with VHF radio, loudhailer, load indicator and boom-mounted video camera with monitor to assist when load hook-ups are out of the normal view of the operator.

With regulatory classifications consisting of ABS loadline, SOLAS/MARPOL, USCG Subchapter L, L/B Myrtle measures 137.5 ft. (41.9-m) with a 92-ft. (28-m) beam and hull depth of 13-ft. (3.9-m). Open deck area is 6,000 sq. ft., and its three legs are 72 in., in diameter and constructed of 1.5-in., wall thickness high strength steel. Power is supplied by two Caterpillar 3512 diesels developing a total of 3,000 bhp, driving Berg controllable pitch propellers through Reintjes reduc-



tion gears. Electrical power is produced by two 190 KW generators driven by Caterpillar 3306 diesels. A 350-bhp hydraulic motor drives the bow thruster.

The Hydraquip jacking system is designed using the latest hydraulic and computer technology to accurately control the leg position. The programmable logic controller provides all jacking system logic, safety interlocks, leg position and alarm monitoring. The hydraulic system incorporates a three speed jacking system that allows leg tagging at 10 ft./min, normal jacking at 4 ft./min and preload jacking at 2 ft./min. The jacking system has counterbalance (holding) valves at each motor for pinion isolation. All jacking system pressures, system status, temperatures, alarms, and operation manual are displayed on a liquid crystal plasma touch screen.

Lift	Lower	Pull	Position
<b>Linepull: 5 Tons to 100 Tons plus!</b>			
<p>HYDRAULIC HOIST</p>			
<p>RAIL CAR PULLER</p>			
<p>TRACTION WINCH</p>			
<p>Designed, engineered and manufactured from stocked, standard components.</p> <p>Priced right, built right and delivered right on time!</p> <p>Phone <b>604-530-0737</b></p> <p>Fax <b>604-530-2889</b></p>			
<p><b>LANTEC</b> a division of IMAC Design Group Ltd.</p> <p>GEAR DRIVES WINCHES &amp; HOISTS BRAKES &amp; CLUTCHES</p> <p>5827 Production Way Langley, British Columbia Canada V3A 4N5</p> <p>www.lantecgear.com email: sales@lantecgear.com</p> <p><b>Driven to Excellence</b></p>			

Circle 323 on Reader Service Card  
or visit www.maritimereporterinfo.com

**SUPERIOR-LIDGERWOOD-MUNDY**

A United States of America Manufacturer  
DESIGNERS AND BUILDERS SINCE 1869

Call us for information...

TOLL FREE: 1 (888) 511-7922    FAX: (715) 394-6199  
PHONE: (715) 394-4444    www.lidgerwood.com

Competitive Prices...  
Short Lead Times...

Highest Quality  
and Efficiency

SLM Corp. • 302 Grand Ave. • PO Box 39 • Superior, WI 54880

**MILLENNIUM-2000 CAPSTANS**

Circle 300 on Reader Service Card  
or visit www.maritimereporterinfo.com

## Trimaran Research helps in the Evolution of Warship Design

### Design Description of RV Triton

Length overall	321 ft. (98 m)
Length between perpendiculars	295 ft. (90 m)
Beam overall	74 ft. (22.5 m)
Depth to main deck	29 ft. (9 m)
Design draught	10 ft. (3.2 m)
Design displacement	1,035 tons
Maximum speed	20 knots
Range	3,000 n.m.

# Three Hulls = One Ship

The U.K. Ministry of Defense (MOD) has been studying the use of the trimaran hullform for its Future Surface Combatant. As part of its research and risk reduction process an ocean going demonstrator Research Vessel (RV) Triton was procured by QinetiQ, the former U.K. Defence Evaluation and Research Agency. From October 2000 to March 2002 it was used in these risk reduction trials and is now available for hire as a general trials ship. Over the past seven years the U.K. Ministry of Defence (MOD) has explored in some detail the potential benefits of a trimaran. Hydrodynamic and structures studies by QinetiQ together with design investigations by the U.K. MOD Director of Naval Architecture and the Surface Ship Concepts Group at QinetiQ have suggested that, for a given requirement, the trimaran could offer:

- Improved powering characteristics at high speed leading to a reduction in installed power;
- Alternative ship layout options helping to optimise operational effectiveness and the potential to improve survivability;
- The ability to adjust the hull configuration to cater for through life changes, which would significantly effect stability;
- An upper deck layout and superstructure design that can be more aviation friendly;
- The ability to fit larger weapons and sensors higher up with less penalties than for a monohull; and
- Greater scope to accommodate alternative propulsion arrangements including independent propulsion in side hulls improving damage tolerance.

Many of these potential benefits will be explored by the design and build of RV Triton, the Trimaran Demonstrator and an extensive series of sea trials.

#### Trimaran Research

The first work was carried out at the University College in London where the U.K. MOD sponsors a department, studying warship design. In the late 1980's

task of designing various trimaran warships. The results of this work were so encouraging that the Director of Operational Requirements within the U.K. MOD decided to fund research work at QinetiQ to confirm the advantages promised by the hullform and also to understand the design constraints imposed on the use of the hullform in warship design.

This work started in 1994 and initially concentrated on the hydrodynamic aspects of the hull design, which was carried out by running small-scale models of typically 26 ft. (8 m) in the tanks at the QinetiQ site at Haslar. The research was successful and the key parameters of main hull length to beam ratios and side hull length and position were identified. While this was progressing computer design tools were developed which predicted the resistance, propulsion, seakeeping and maneuvering characteristics of the trimaran warship. Once the hydrodynamic design was set, our structural experts at Rosyth started to investigate the structural design requirements. This has been largely based on the development of computer codes in a series of numerical models. These have been used to predict loadings and stresses in different sea states, which have allowed the structural rules for the design of trimaran warships to be established. The final area of research covers survivability where any peculiarities of using a long slender hullform are being investigated through the use of scale model experiments and the development of computer based numerical models.

The results of this research have been most encouraging and to date nothing has been identified which negates any of our perceived advantages. However it is a very brave group that would commit to building a fleet of trimaran warships based on the results of small scale model testing. An interim step was needed and this is the Trimaran Demonstrator — RV Triton.

#### The Need for a Demonstrator

It is unusual to build a prototype warship on this

of trimaran warships would represent a significant change from the more conventional monohull, both in terms of the design challenges and the operation of such ships. Perhaps the greatest concern is that of structural design. The critical issue is; exactly what design loads and associated safety factors should be applied? While most other aspects of design and performance can be predicted adequately by mathematical or small scale physical modeling, structural synthesis relies on knowledge of the loads the ship is likely to encounter.

Warships are inherently lightweight structures to maximize payload in a small platform and to ensure high speed at minimum cost. A conservative approach to the structural design of a trimaran could severely penalize the form when compared to a mono-hull designed to the same requirement. To enable appropriate design criteria to be established an accurate knowledge of the loads which an ocean-going trimaran will experience is required.

#### Developing the Requirement

During the early stages of the project it became clear that it would take about two years of sea trials to gather the structural load data required by the MOD. However, a financial commitment to purchase a vessel of this size with use for just two years was not viable. To justify the procurement of RV Triton, a business case was prepared showing that an acceptable return on investment could be provided by a program of various trials over a 15-year period. RV Triton therefore has two roles. First, as a research tool and subsequently as a trials vessel with flexibility to fit and trial many disparate weapons and commercial systems.

Given the need to produce "frigate like" structural data, the first question to be answered was "how big should the demonstrator be?" This question was put to DNV the classification society that was selected, and the U.K. MOD's structural experts at Rosyth. They were both asked to consider the time required to gath-

## President Cuts USCG Funding

On August 13, President Bush hosted the President's Economic Forum at Baylor University in Waco, Texas, bringing together a variety of individuals to discuss the fundamentals of the economy and the President's agenda to increase economic growth for the future.

From the President's Statement at the Economic forum Plenary Session, President Bush indicated that he will refuse to spend a \$5 billion package included in the 2002 Supplemental Appropriations Act for Further Recovery from and Response to Terrorist Attacks on the United States stating, "Congress, for the long-term economic security of America, needs to restrain spending.... And if the Congress won't show spending restraint, I intend to enforce spending restraint."

The President is opposed to several of the individual expenditures in the package, including \$273 million in supplemental funding for the Coast Guard: "But those who wrote the bill designed it so I have to spend all \$5 of the extra billion dollars or spend none of it. That's how they wrote the supplemental. Those are the rules they placed upon my administration. I understand their position, and today they're going to learn mine. We'll spend none of it."

That supplemental funding is now rescinded.

## SENESCO To Construct 171-Ft. Hopper Barge

The Southeastern New England Shipbuilding Corporation (SENESCO) has signed a major barge contract for construction of a 171-ft. (52.1-m) hopper barge that will have a holding capacity of 2,750 cu. yds. Construction has already begun and is expected to be completed this fall. The barge is being built for Disch Construction of Summit, N.J. who will use the barge to transport dredge spoils.

In addition to an increase in its executive ranks and the announcement of the Disch contract, SENESCO also recently completed a multi-vessel repair contract for Modern Continental, a Boston-based construction company.

SENESCO's repair business is expected to grow even further when the company launches a new dry dock it is building at its Quonset Point, R.I. facility. The new dry dock will allow the company to repair larger vessels and also enable Senesco to launch larger barges, including the 320-ft. (97.5-m), 80,000 barrel double hulled liquid fuel barge being built for Don Church of Sea Boats, Inc.

Circle 12 on Reader Service Card  
www.maritimereporterinfo.com

# Bollinger Builds Next Generation Liftboat

The evolution of liftboats took a giant leap forward when Bollinger Shipyards, Inc., delivered L/B Myrtle, a 137.5-ft. (41.9-m) liftboat to Montco Offshore, Inc., Golden Meadow, La. Equipped with 245-ft. (74.6-m) legs, the self-propelled floating platform has the ability to work in water depths to 180 ft. with a 15-ft. air gap while lifting a total of 850 kips of variable load.

What sets L/B Myrtle apart from other liftboats is that it is equipped with a bow thruster and controllable pitch (CP) propellers for greater maneuverability and pinpoint positioning of the huge legs with oversized pads on the ocean bottom.

The vessel's namesake is in honor of **Myrtle Orgeron**, mother of **Lee Orgeron**, and is equipped with 40 x 16-ft. pads (12.1 x 4.8-m), much larger than those on other liftboats, to provide for greater bottom stability and greater deck loads. The L/B Myrtle can also jack with a full pre-load and its pre-load system has quick acting stainless steel dump valves.

It is equipped with three Nautilus cranes with 150, 50 and 25-ton capacities in an innovative configuration. The smaller crane is positioned on the starboard stern so that support vessels can tie-up to the liftboat and offload personnel, cargo, and/or fluids without hindering other work being done by the liftboat. The 150-ton crane has a 110-ft. boom and is equipped with VHF radio, loudhailer, load indicator and boom-mounted video camera with monitor to assist when load hook-ups are out of the normal view of the operator.

With regulatory classifications consisting of ABS loadline, SOLAS/MARPOL, USCG Subchapter L, L/B Myrtle measures 137.5 ft. (41.9-m) with a 92-ft. (28-m) beam and hull depth of 13-ft. (3.9-m). Open deck area is 6,000 sq. ft., and its three legs are 72 in., in diameter and constructed of 1.5-in., wall thickness high strength steel. Power is supplied by two Caterpillar 3512 diesels developing a total of 3,000 bhp, driving Berg controllable pitch propellers through Reintjes reduc-



tion gears. Electrical power is produced by two 190 KW generators driven by Caterpillar 3306 diesels. A 350-bhp hydraulic motor drives the bow thruster.

The Hydraquip jacking system is designed using the latest hydraulic and computer technology to accurately control the leg position. The programmable logic controller provides all jacking system logic, safety interlocks, leg position and alarm monitoring. The hydraulic system incorporates a three speed jacking system that allows leg tagging at 10 ft./min, normal jacking at 4 ft./min and preload jacking at 2 ft./min. The jacking system has counterbalance (holding) valves at each motor for pinion isolation. All jacking system pressures, system status, temperatures, alarms, and operation manual are displayed on a liquid crystal plasma touch screen.

Lift	Lower	Pull	Position
<b>Linepull: 5 Tons to 100 Tons plus!</b>			
Designed, engineered and manufactured from stocked, standard components.			
Priced right, built right and delivered right on time!			
Phone <b>604-530-0737</b> Fax 604-530-2889			
<b>LANTEC</b> a division of IMAC Design Group Ltd.			
GEAR DRIVES WINCHES & HOISTS BRAKES & CLUTCHES			
5827 Production Way Langley, British Columbia Canada V3A 4N5			
<b>Driven to Excellence</b>			
www.lantecgear.com email: sales@lantecgear.com			

Circle 323 on Reader Service Card  
or visit www.maritimereporterinfo.com

**SUPERIOR-LIDGERWOOD-MUNDY**

A United States of America Manufacturer  
DESIGNERS AND BUILDERS SINCE 1869

Call us for information...

TOLL FREE: 1 (888) 511-7922    FAX: (715) 394-6199  
PHONE: (715) 394-4444    www.lidgerwood.com

Competitive Prices...  
Short Lead Times...

Highest Quality  
and Efficiency

SLM Corp. • 302 Grand Ave. • PO Box 39 • Superior, WI 54880

**MILLENNIUM-2000 CAPSTANS**

Circle 300 on Reader Service Card  
or visit www.maritimereporterinfo.com

## Trimaran Research helps in the Evolution of Warship Design

### Design Description of RV Triton

Length overall	321 ft. (98 m)
Length between perpendiculars	295 ft. (90 m)
Beam overall	74 ft. (22.5 m)
Depth to main deck	29 ft. (9 m)
Design draught	10 ft. (3.2 m)
Design displacement	1,035 tons
Maximum speed	20 knots
Range	3,000 n.m.

# Three Hulls = One Ship

The U.K. Ministry of Defense (MOD) has been studying the use of the trimaran hullform for its Future Surface Combatant. As part of its research and risk reduction process an ocean going demonstrator Research Vessel (RV) Triton was procured by QinetiQ, the former U.K. Defence Evaluation and Research Agency. From October 2000 to March 2002 it was used in these risk reduction trials and is now available for hire as a general trials ship. Over the past seven years the U.K. Ministry of Defence (MOD) has explored in some detail the potential benefits of a trimaran. Hydrodynamic and structures studies by QinetiQ together with design investigations by the U.K. MOD Director of Naval Architecture and the Surface Ship Concepts Group at QinetiQ have suggested that, for a given requirement, the trimaran could offer:

- Improved powering characteristics at high speed leading to a reduction in installed power;
- Alternative ship layout options helping to optimise operational effectiveness and the potential to improve survivability;
- The ability to adjust the hull configuration to cater for through life changes, which would significantly effect stability;
- An upper deck layout and superstructure design that can be more aviation friendly;
- The ability to fit larger weapons and sensors higher up with less penalties than for a monohull; and
- Greater scope to accommodate alternative propulsion arrangements including independent propulsion in side hulls improving damage tolerance.

Many of these potential benefits will be explored by the design and build of RV Triton, the Trimaran Demonstrator and an extensive series of sea trials.

#### Trimaran Research

The first work was carried out at the University College in London where the U.K. MOD sponsors a department, studying warship design. In the late 1980's as part of their MSc course, students were given the

task of designing various trimaran warships. The results of this work were so encouraging that the Director of Operational Requirements within the U.K. MOD decided to fund research work at QinetiQ to confirm the advantages promised by the hullform and also to understand the design constraints imposed on the use of the hullform in warship design.

This work started in 1994 and initially concentrated on the hydrodynamic aspects of the hull design, which was carried out by running small-scale models of typically 26 ft. (8 m) in the tanks at the QinetiQ site at Haslar. The research was successful and the key parameters of main hull length to beam ratios and side hull length and position were identified. While this was progressing computer design tools were developed which predicted the resistance, propulsion, seakeeping and maneuvering characteristics of the trimaran warship. Once the hydrodynamic design was set, our structural experts at Rosyth started to investigate the structural design requirements. This has been largely based on the development of computer codes in a series of numerical models. These have been used to predict loadings and stresses in different sea states, which have allowed the structural rules for the design of trimaran warships to be established. The final area of research covers survivability where any peculiarities of using a long slender hullform are being investigated through the use of scale model experiments and the development of computer based numerical models.

The results of this research have been most encouraging and to date nothing has been identified which negates any of our perceived advantages. However it is a very brave group that would commit to building a fleet of trimaran warships based on the results of small scale model testing. An interim step was needed and this is the Trimaran Demonstrator — RV Triton.

#### The Need for a Demonstrator

It is unusual to build a prototype warship on this scale, but there is a great deal at stake. Running a fleet

of trimaran warships would represent a significant change from the more conventional monohull, both in terms of the design challenges and the operation of such ships. Perhaps the greatest concern is that of structural design. The critical issue is; exactly what design loads and associated safety factors should be applied? While most other aspects of design and performance can be predicted adequately by mathematical or small scale physical modeling, structural synthesis relies on knowledge of the loads the ship is likely to encounter.

Warships are inherently lightweight structures to maximize payload in a small platform and to ensure high speed at minimum cost. A conservative approach to the structural design of a trimaran could severely penalize the form when compared to a mono-hull designed to the same requirement. To enable appropriate design criteria to be established an accurate knowledge of the loads which an ocean-going trimaran will experience is required.

#### Developing the Requirement

During the early stages of the project it became clear that it would take about two years of sea trials to gather the structural load data required by the MOD. However, a financial commitment to purchase a vessel of this size with use for just two years was not viable. To justify the procurement of RV Triton, a business case was prepared showing that an acceptable return on investment could be provided by a program of various trials over a 15-year period. RV Triton therefore has two roles. First, as a research tool and subsequently as a trials vessel with flexibility to fit and trial many disparate weapons and commercial systems.

Given the need to produce "frigate like" structural data, the first question to be answered was "how big should the demonstrator be?" This question was put to DNV the classification society that was selected, and the U.K. MOD's structural experts at Rosyth. They were both asked to consider the time required to gather the data, the areas the ship would be tested in and the



loads that had to be generated in order that a sensible extrapolation to design and extreme conditions could be achieved reliably. Both studies concluded, independently, that a vessel of between 295 and 361 ft. (90 and 110 m) should provide the data necessary to validate numerical and small-scale physical models. Since the main function of the ship is to be a "structural

transducer" it is imperative that the structure is representative of a warship and as light as possible so that induced strains can be measured by the onboard instrumentation with the minimum of error. Obviously the need for the lightest structure could compromise the structural safety of this ocean-going ship. Studies were carried out to investigate the best way of

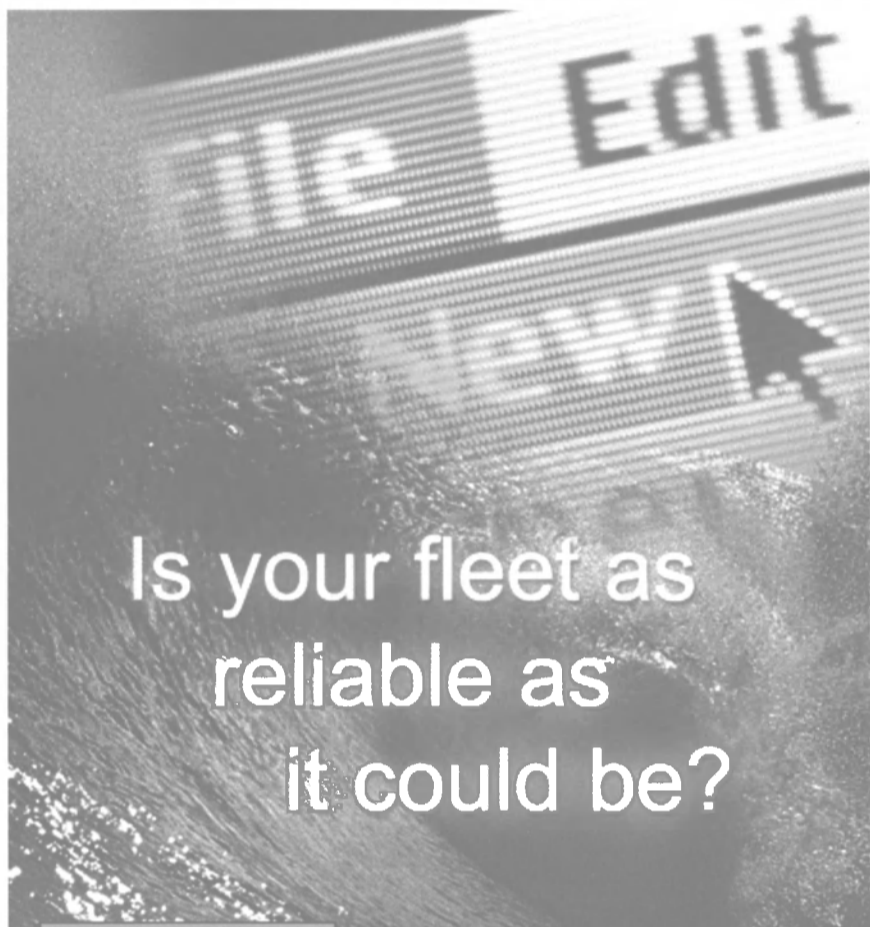

Is your fleet as reliable as it could be?

Find out how Resurgence™ Software can help you optimize the reliability and financial performance of your fleet by maximizing vessel uptime, minimizing maintenance costs and reducing the risks of failure.

By using the Wave™ Software System, our industry leading equipment reliability analysis and risk management solution, you will have the information you need to make better, more informed decisions about your fleet's performance, including critical maintenance, repair versus replace and procurement decisions.

Contact Resurgence™ Software today to schedule an Internet-based or personal demonstration of the Wave™ Software System.



WEB: [www.resurgence-software.com](http://www.resurgence-software.com)  
 E-MAIL: [info@resurgence-software.com](mailto:info@resurgence-software.com)  
 PHONE: +1 (504) 304-2510 USA TOLL-FREE: (800) 740-0574

Circle 342 on Reader Service Card  
 or visit [www.maritimereporterinfo.com](http://www.maritimereporterinfo.com)

September, 2002

## CRANKSHAFT GRINDING

While Installed in Engine

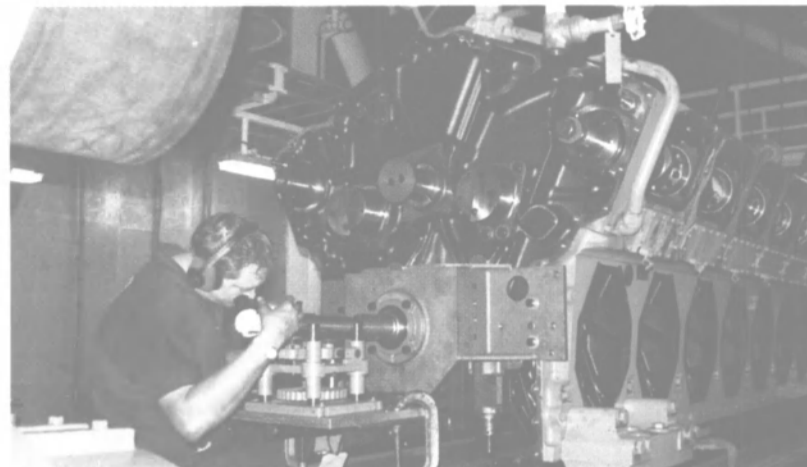

- **CRANKPIN AND MAIN JOURNAL REFURBISHING**  
While crankshaft is in engine
- **LINE BORING OF MAIN BEARING POCKETS**  
Laser and Optical Alignment
- **ALL TYPES OF ON-BOARD MACHINING** Cylinder boring, engine top decks, horizontal joints, couplings, journals
- **METALSTITCH®**  
Repair of cracked or broken cast iron engine blocks



### IN-PLACE MACHINING COMPANY

USA: 800-833-3575 International: 414-562-2000 FAX: 414-265-1000  
 24 HOUR EMERGENCY SERVICE...day or night, 365 days a year  
 email: [help@inplace.com](mailto:help@inplace.com) Website: [www.inplace.com](http://www.inplace.com)

Circle 243 on Reader Service Card  
 or visit [www.maritimereporterinfo.com](http://www.maritimereporterinfo.com)

## WE HAVE QUITE A WEIGHTING LIST

If your vessel requires fixed ballast, you shouldn't go to sea without us.



PROVEN PROCESS  
 PROVEN SYSTEM  
 PROVEN COMPANY

FIXED BALLAST MATERIALS  
 AND INSTALLATION



BALLAST TECHNOLOGIES, INC.  
 520-790-2229 FAX: 520-790-2239 [WWW.BALLASTTECH.COM](http://WWW.BALLASTTECH.COM)

Circle 211 on Reader Service Card  
 or visit [www.maritimereporterinfo.com](http://www.maritimereporterinfo.com)

## Navy

ensuring structural safety. These showed that adopting a structural design code such as the DNV High Speed Light Craft rules, should result in a structure similar in style to a typical Royal Navy frigate. Safety of the vessel will, therefore, be demonstrated by adherence to appropriate Classification Society rules. To ensure the "structural transducer"

role is not compromised the contractor was required to obtain confirmation from DNV that the structural weight of RV Triton was minimized.

As well as providing a mechanism for a safe structural design the adoption of classification society standards was also consistent with the need for the vessel to be operated by QinetiQ using a contract-

ed commercial crew. This approach meant that RV Triton would also need to meet the requirements of the Maritime and Coastguard Agency and be registered as a U.K. merchant vessel.

### Trials Instrumentation System

Clearly, a structural demonstrator is of little use unless the structural responses

can be measured and recorded. RV Triton has been fitted with a significant instrumentation package feeding data into a central recording facility. The system records more than 300 channels covering a wide range of data from structural instruments and other sources such as machinery control, ship motion, steering gear, navigation and the environment. The Trials Instrumentation System (TIS), as it is known, has been developed by the US Navy from the system installed in the SWATH T-AGOS 19 and will be fitted to RV Triton under an inter-governmental agreement.

### Hydrodynamic Parameters

A number of hydrodynamic studies were carried out at Haslar as part of the trimaran research program. These were used to generate a reference hull form and to define the required hydrodynamic parameters. During the early stages of the program it emerged that under certain stern quartering sea conditions and with the ship having a metacentric height of that expected of a trimaran

### Primary Design Drivers

The requirement for Triton to be a "structural transducer," combined with the novelty of the hull form, led to the design being driven predominantly by three issues:

#### 1. Structural Design

The initial structural design was carried out in accordance with the High Speed and Light Craft Rules of DNV. However, with no historical data on which to base predictions it was imperative to estimate, without undue conservatism, the structural loads resulting from motions in a seaway at various speeds and at various headings. To achieve this, DNV used their SWAN package which simulates the passage of the vessel through a given seastate to generate estimates of the in service and extreme loads. The results of the simulations were time dependent predictions of structural loading which were then, together with a number of quasi-static load cases from the DNV rules, used as the basis for global finite element and fatigue analysis of the structure. This work revealed a number of potential problem areas with the initial structural design. For example, high stresses from transverse wave loading were induced in 2 deck around the transverse bulkheads which could have led to buckling. Panel stiffeners and some increases in plate thickness were necessary.

#### 2. Hydrodynamics

One of the central justifications for the adoption of the trimaran configuration has been the benefit of lower resistance leading to higher speeds or lower installed power. For this reason, the minimization of resistance, in particular at top speed, has been a high priority during the design.

The extensive experience gained by QinetiQ during its model testing enabled a highly efficient configuration to be developed within the constraints laid down by the specification.

The main hydrodynamic parameters of the hull form are as follows:

Length waterline	298 ft. (91 m)
Side hull % of total displacement	3.7 percent
Main hull CB	0.49
Main hull B/T	2.14
Side hull LWL	112 ft. (34.2 m)
Side hull BWL	4 ft. (1.4 m)
Side hull draught	7 ft. (2.3 m)
Side hull separation	30 ft. (9.3 m)
Side hull longitudinal position	2.25m aft amidships

#### 3. Stability

The specification required that both Naval Standards, supplemented by a specific trimaran GZ shape criterion, and MCA requirements were met. The only standard used by MCA that is appropriate to multihull craft is the SOLAS high-speed craft code.

## We Offer Marine HVAC Solutions Based On 40 Years Of Engineering Excellence.

For nearly half a century, Cruisair and Marine Air Systems have been the foremost names in marine HVAC technology. In 1999, we brought these two well-respected brands together with the formation of Taylor Made Environmental.

Today you can look to us for a complete range of turnkey air conditioning

and heating solutions, for circulated-water, seawater-cooled and air-cooled applications. Cruisair and Marine Air Systems products are designed by professional engineers who understand the unique requirements of the marine environment. They're built at state-of-the-art plants by skilled craftsmen who take pride in their work. They're backed by our extensive applications engineering group, and sustained by our worldwide network of factory-trained service dealers. So give us a call or send us your specs, and let us show you how we can solve your next marine HVAC job.

### And That's Not All.

**fruisair**

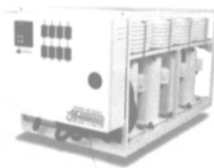

MARINE AIR SYSTEMS  
**AIR**

Taylor Made  
ENVIRONMENTAL

TAYLOR MADE  
GROUP

A-0151, A-0152, A-0153

hvac@tmenviro-va.com • www.tmenviro.com • Tel: +1-804-746-1313 (US) • +44(0)870 3306101 (UK)

Circle 301 on Reader Service Card or visit [www.maritimereporterinfo.com](http://www.maritimereporterinfo.com)

## Maritime Multi Display

Jhd HATTELAND  
DISPLAY

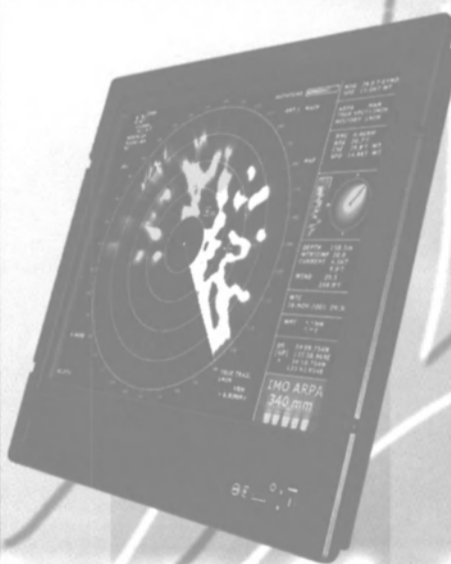

23.1 Inch MMD Display - Compliant with:  
IMO ARPA 340mm Radar & ECDIS

The new complete product line  
for marine and naval applications.

Display range from 15 to 23,1 inch

- IEC 945 tested
- MIL tested
- IP rated
- Type approved
- ARPA compliant
- ECDIS compliant

[www.hatteland.com](http://www.hatteland.com)

Jakob Hatteland Display AS  
Åmsosen, N-5578 Nedre Vats, Norway  
Tel: (+47) 5276 3700 - Fax: (+47) 5276 5444  
e-mail: [jhd-no@hatteland.com](mailto:jhd-no@hatteland.com) - url: <http://www.hatteland.com>



Circle 238 on Reader Service Card or visit [www.maritimereporterinfo.com](http://www.maritimereporterinfo.com)

warship, models exhibited unacceptable dynamic roll characteristics. With a shorter roll period, equivalent to that of a scaled mono-hull, this characteristic improved. Exploration of this phenomena during the trials of RV TRITON is a vital part of trimaran development. Tight control of the predicted roll period of the vessel was included in the specification.

The contract for the design and build of RV Triton was placed with Vosper Thornycroft in July 1998 as the result of a competitive tender process. The ship was launched in May 2000 and delivered to QinetiQ (then DERA) in August of the same year.

#### Hull Form

The main hull is of round bilge form with underwater sections approaching semi-circularity amidships. A gentle rise of buttock lines aft leads to a counter-stern transom with minimal immersion. The sidehulls are of multi-chine design on the outboard face with a plane inboard face for ease of manufacture. A parallel section is included extending above and below the waterline to avoid large changes in waterplane as displacement varies. Above this there is a flared section outboard and a haunch inboard to provide additional buoyancy as the opposite side hull emerges when heeling. Both hull and decks are longitudinally stiffened and supported by transverse frames at 1,500 mm spacing. Frames are fabricated up to two-deck level while above this both frames and deck beams are flanged. The steel grade used has a yield stress of 265 Mpa that is similar to the main structural steel used on frigates.

#### Propulsion

RV Triton is a diesel electric ship with both propulsive and ship service power provided by a pair of diesel generators. Drive is provided by a single conventional shaftline in the main hull, plus a right angle drive thruster in each side hull. The main shaft is driven by a single 3.5MW AC electric motor through a reduction gearbox. Side hull thrusters are driven by 350 kW electric motors. The prime movers are two Paxman 12VP185 powered 2MW diesel generators backed up by a 400 kW harbour set and an 80 kW emergency set.

A single fixed pitch propeller and rudder are conventionally arranged under the aft end of the main hull. The capability to fit a larger permanent magnet motor of up to 5 MW power has also been provided so that any related trials could contribute to the business case.

#### Sea Trials Summary Report

Since delivery to QinetiQ in August 2000, RV Triton has been conducting sea trials for the UK Ministry of Defence and the US Department of Defense to evaluate the performance of

the trimaran hullform in various operational scenarios and environmental conditions.

All the trials were carried out under a Memorandum of Understanding between the two governments. These trials completed in March 2002.

These trials were conducted in various sea states and at different speeds to ensure the ship encountered a diverse set

of sea conditions. One of the perceived advantages of the trimaran hullform is the decrease in resistance and the lower power required to drive the ship when compared against the equivalent displacement monohull. In trials this has been proved as a reduction at high speed.

RV Triton has good directional stability due to its long centre hull and the sea

trials have proved that she is far more comfortable in higher sea states than a monohull. Towing operations were conducted in one sea state higher than had previously been conducted for ships of RV Triton's size.

#### Structural Loading

Although considerable research had been successfully carried out, the risk



### ROYAL FLUSH

- Powerful Jet Macerator
- 1 1/2" Discharge Piping
- 5 Year Warranty
- Weight And Space Saving Vacuum Alternative
- Labor-Saving Installation







### TYPE II MSD

- USCG/IMO Certified
- No Harsh Chemicals
- Custom Designs Available
- Lightweight
- Steel, Plastic, or Aluminum Construction

tel 954-581-6996 fax 954-587-0403 www.headhunterinc.com  
4100 RAVENSWOOD RD. FT. LAUDERDALE, FL 33312

## Branch Out!

Wallace Coast's saddle and hole cutter  
*now has new & improved features*

- Match branch and saddle with PC-Based control
- Inch/metric selectable
- Language selectable
- Cut and bevel pipe from 32mm to 1200mm
- New cuts

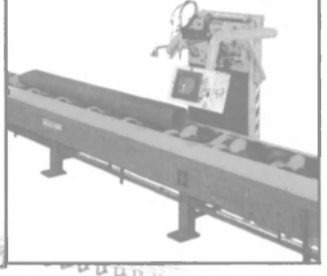

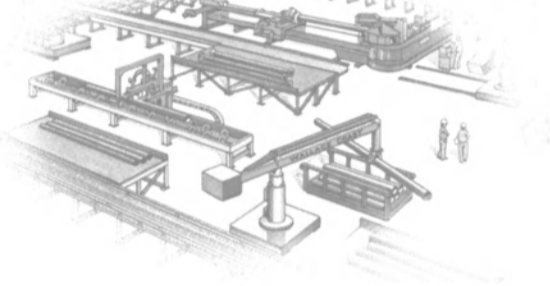



SHAPING THE WORLD AROUND YOU  
+01-253-922-7433 tmorgan@jesse-wallace.com www.jesse-wallace.com  
Jesse Engineering manufactures Wallace Coast pipe benders, pipe shop equipment and PipeShop® software.  
See us at Fabtech, booth #14102



## Approved On time Up to date

ChartCo's satellite broadcast service delivers instant, fully approved updates to paper or electronic charts and weather forecasts at a fraction of the cost of email downloads or the time delay of CD alternatives. This access to the latest information improves crew time management, optimises safety and ensures a chart correction audit trail. All this at an easy to budget fixed cost.

- ChartManager BA and US digital Notices to Mariners
- MetManager weather forecasting and routing
- oceanXpress electronic navigation data
- Daily and weekly crew newspapers





Web: www.chartco.com E-mail: sales@chartco.com Tel: +44 (0)20 8267 0003

## Protecting Gears and Shafts from Vibration

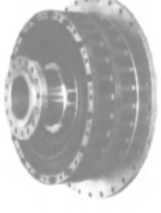

### VULKAN Flexible Couplings

RATO Family • Main Propulsion • EZR • Auxiliary Propulsion • Vulastik-L • GenSets  
Vulkardan • Cardan Drives • Propflex • Composite Shafts • Monitoring Devices • VKE • Torflex • Up to 464,660 lb-ft. torque.

**American VULKAN**  
Sales and Service 863-324-2424 Fx: 863-324-4008  
www.vulkanusa.com • ISO 9002 and QS 9000

## Navy

with trimarans was considered to be in determining the structural design of the ship particularly at the junction of the mainhull and sidehulls together with slamming loads on the underside of the cross-deck. This could only be determined by gathering structural strain and load data at ocean going scale. RV Triton conducted a number of specific

structures trials where she encountered a wide variety of sea states from sea state 2 through to sea state 8.

The data gathered correlated well with the predicted computer model results with the anticipated results. The ship behaved extremely well in all trials the hull suffered no damage.

## Northrop Grumman Preble (DDG 88)

Northrop Grumman Corporation delivered to the U.S. Navy its newest warship — Preble (DDG 88) — an Aegis guided missile destroyer built by the shipyard's facility in Pascagoula, Miss. Preble is the 38th ship in the DDG 51 Arleigh Burke-class of Aegis guided



# More heat exchange solutions. One heat exchange leader. Duramax® Marine.

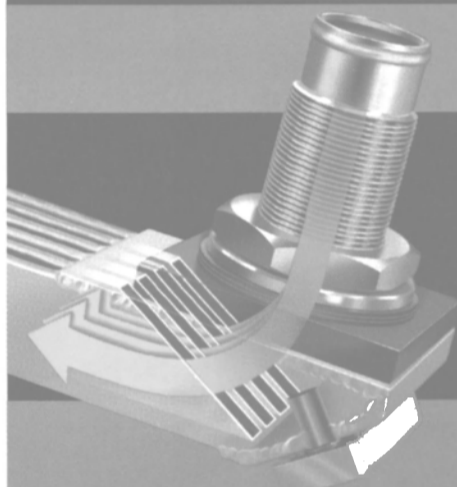

### DuraCooler®

- ▶ Streamlined head for improved internal/external flow
- ▶ Lower pressure drop across keel cooler
- ▶ Compact footprint with increased cooling surface area

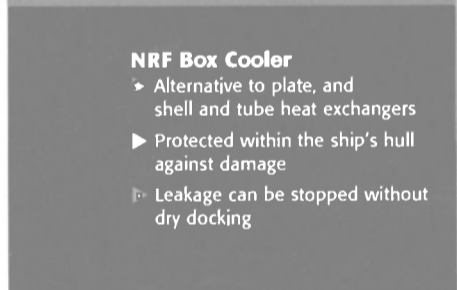

### NRF Box Cooler

- ▶ Alternative to plate, and shell and tube heat exchangers
- ▶ Protected within the ship's hull against damage
- ▶ Leakage can be stopped without dry docking



### Johnson Demountable Keel Cooler

- ▶ No through hull fittings
- ▶ Replaceable parts
- ▶ Cool multiple circuits with one cooler

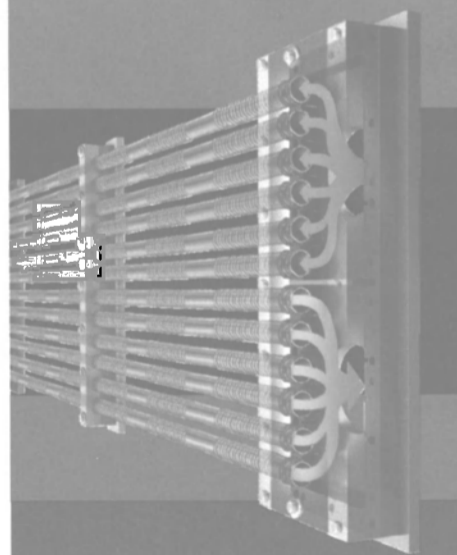

Every heat exchange application is unique. Different vessels, operating conditions, engines and equipment all require specialized cooling solutions. We recognize that one heat exchange product can't fit all applications. That's why Duramax® Marine continues to expand its line of heat exchange products.

Each heat exchange solution Duramax® Marine provides is unique in design and performance. With more than 30 years experience in heat transfer and a full-scale testing program, we understand the differences that will help you select the DuraCooler® sized for your application. We back that selection with our exclusive Guarantee of Thermal Efficiency.

In addition to our heat exchange products, Duramax® Marine provides a host of other quality, value-added, engineered marine solutions, including water-lubricated bearings, shaft sealing systems and marine fendering systems.

Contact Duramax® Marine — your leader in total marine solutions — for all your heat exchange needs. For a free consultation, please call us today at 440.834.5400 or visit [www.duramax-marine.com](http://www.duramax-marine.com).



# DURAMAX® MARINE LLC

17990 GREAT LAKES PARKWAY ■ HIRAM, OHIO 44234 USA ■ PHONE 440.834.5400 ■ FAX 440.834.4950

missile destroyers. In naming DDG 88 Preble, the Navy, for the sixth time, honors Cmdr. **Edward Preble**, (1761-1807), a pioneer in U.S. naval and merchant marine service. With Cmdr. **Timothy Batzler**, USN, a native of Baltimore, Md., and a 1983 graduate of the U.S. Naval Academy, as the new ship's commissioning commanding officer, Preble will depart from Pascagoula in October where it will join the U.S. Pacific Fleet during commissioning ceremonies Nov. 9, 2002, in Boston, Mass. — moving on to its homeport in San Diego, Calif.

Circle 42 on Reader Service Card  
[www.maritimereporterinfo.com](http://www.maritimereporterinfo.com)

## McC Campbell Commissioned

The U.S. Navy commissioned Arleigh Burke class guided missile destroyer, McC Campbell on Aug. 17, 2002. Measuring 510 ft. (155 m), with a 59-ft. (17.9-m) waterline beam, the ship, which honors the late Navy Capt. **David McC Campbell** (1910-1996), who is the Navy's top ace with 34 confirmed aerial victories and recipient of the Medal of Honor while serving as commander, Air Group 15, the USS Essex, during the Battle of the Philippine Sea (June 19, 1944) and the Battle of Leyte Gulf (October 24, 1944). During the first encounter, McC Campbell's force virtually annihilated an attacking force of 80 Japanese carrier-based aircraft, of which he personally shot down seven. In the Battle of Leyte Gulf, he daringly attacked a formation of at least 60 Japanese land-based aircraft. McC Campbell shot down at least nine of these aircraft, forcing the remainder to abandon the attack. In addition to the Medal of Honor, McC Campbell received the Navy Cross, Silver Star and Distinguished Flying Cross. No previous ship has been named McC Campbell.

Construction of DDG 85 took place at Bath Iron Works in Bath, Maine.

Circle 317 on Reader Service Card or visit [www.maritimereporterinfo.com](http://www.maritimereporterinfo.com)

# What Hull Shape Is Best?

Back at the dawn of maritime history, a coastal dweller first took a log and ventured out on the water. Over time his craft evolved from a rough log to one that had shape at the ends and was hollowed out. These changes to the basic log shape were the first example of modifying a hull form to increase carrying capacity, improve ride comfort, and to reduce resistance. Since then, shipbuilders, naval architects, and ship owners have experimented with hull shapes and the number of hulls to find the "best" design. Let's look at some of those variations to understand the challenges of choosing a hull shape. — by John Waterhouse

## Monohull Design

The basic monohull can be defined by six key numbers: length, beam, depth of hull at midships, design draft, prismatic coefficient, and displacement. Length, beam, and draft are familiar to everyone. Depth of hull at midships gives an idea of the freeboard as well as an indication of the hull strength in bending. The prismatic coefficient is a measure of how much shape there is in the ends of a hull. A high prismatic coefficient means that the ends are full such as a tanker bow. A low prismatic coefficient means that the ends are fine, with little volume, such as a tugboat stern.

The choice of what dimensions to use depends on the intended use of the vessel. For a passenger vessel, there are considerations of carrying capacity, operating environment, and type of operation. Clearly, a 400-passenger dinner boat operating on a river will have different characteristics than a 400-passenger overnight car ferry operating in Alaska. Characteristics the riverboat hull will likely have include:

- **Shallow Draft** — allowing the vessel to operate near river banks at various river levels
- **Relatively low freeboard** — vessel is not subject to the bending forces from ocean waves
- **Relatively high beam** — provides stability since there is little of the vessel down in the water
- **Moderate displacement** — the variable load (people, fuel, provisions) is relatively small
- **Low prismatic** — the hull operates at modest speeds and low horsepower

Further refinements of the hull shape have to do with factors such as: type of propulsion, sea conditions the vessel will experience, method of construction, and handling characteristics. Using our example of a riverboat, the after portion of the hull

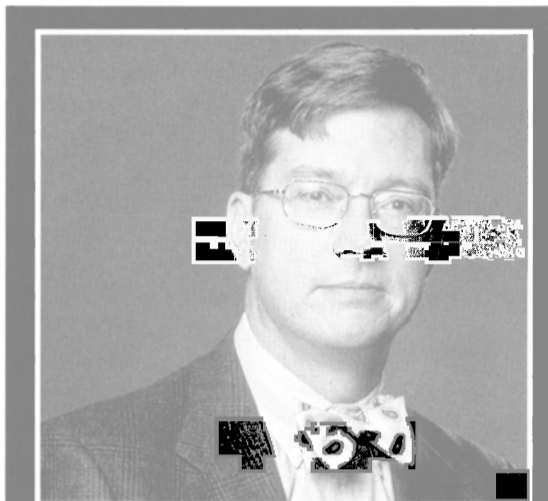

By John Waterhouse, P.E., president, Elliott Bay Design Group, Seattle, Wash.

will be shaped differently if the vessel is propelled by a paddlewheel versus propellers in tunnels. Similarly, for steel construction, the designer must decide whether to choose a molded hull or a hard-chine hull. The latter construction method is less expensive, but may require more power to drive at the same speed.

## Key Factors in Hull Shape Selection

Speed and displacement are key factors in choosing a hull shape. To a waterfront observer, a 600-ft. (182.8-m) tanker moving at eight knots leaves little or no apparent wake behind it while an 80-ft. (24.3-m) tug operating at the same speed leaves a very noticeable wake. The great naval architect William Froude showed us that the wave-making resistance of a vessel is proportional to the square root of the vessel's waterline length, or:

$$R_w = \frac{\text{Speed}}{(\text{waterline length})^{1/2}}$$

The tanker is operating at eight knots divided by the square root of 600 ft., or a so-called speed-length ratio of 0.33, while the tug is operating at a speed-length ratio of 0.89. Relative to its size, the tug is putting more effort into moving through the water.

Another factor in hull design is the displacement. Our tanker has a displacement of some 46,700 long tons versus some 301 long tons for the tug. However, if they both had the same hull shape, say the tug was shaped like the tanker, the tug's displacement would only be 110 tons, its beam would be

Figure 1: Hull Shape Comparison Chart

Vessel Type	Length oa (ft)	Length wl (ft)	Beam (ft)	Depth hull midship (ft)	Design draft (ft)	Displ. (long tons)	Prismatic Coeff.	Design speed (knots)	Speed/ Length Ratio	Displ/ Length Ratio
Fast Ferry (Catamaran)	134.5	115.5	9.8	13.9	6.5	84	0.60	36.0	3.35	54
Trans-Atlantic Liner	1029.3	962.0	117.8	91.8	36.6	68350	0.58	29.5	0.95	77
Riverboat	274.0	241.0	62.0	8.5	6.0	1497	0.70	8.7	0.56	107
Fast Ferry (Monohull)	98.0	88.0	22.0	9.5	5.6	83	0.70	26.0	2.77	122
Tanker	620.0	600.0	100.0	46.0	34.0	46700	0.76	14.5	0.59	216
Tug	80.0	80.0	29.0	13.1	10.0	301	0.58	12.0	1.34	588

Note: Beam, Displacement, and all ratios are given for the demi-hull of the catamaran

## EVOLUTION one12

THE BIGGER THE SHIP, THE BETTER THE BOTTOM LINE

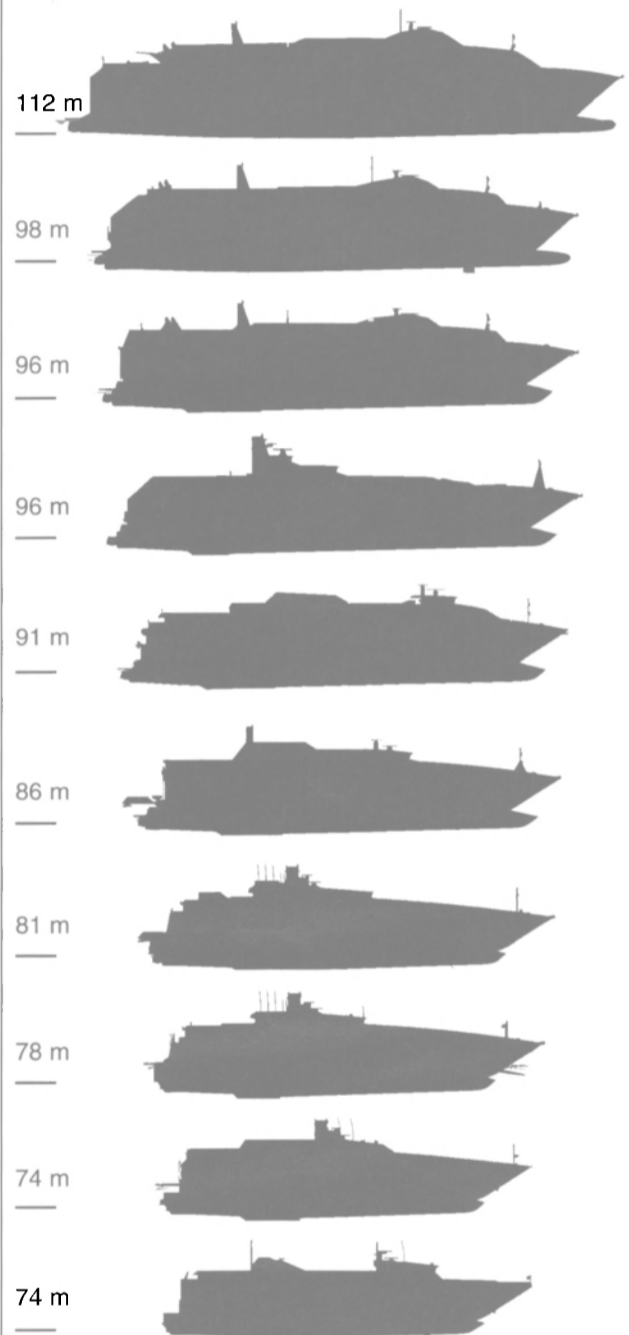

18 Bender Drive, Hobart, Tasmania 7009 Australia.  
 TEL: +61 3 6273 0677 FAX: +61 3 6273 0932  
 Email: incat@incat.com.au Website: http://www.incat.com.au

Circle 242 on Reader Service Card  
 or visit [www.maritimereporterinfo.com](http://www.maritimereporterinfo.com)

## Naval Architecture • Marine Engineering

only 13.3 ft. (4.4 m) versus 29 ft. (8.8 m) and the depth of hull would be only 6.1 ft. (1.8 m) versus 13.1 ft. (3.9 m). Clearly one shape does not fit all vessels. Since vessel displacement is roughly proportional to the length cubed, we can group vessels by a so-called displacement-length ratio (DLR), which is

defined as:

$$\text{DLR} = \frac{\text{Displacement (long tons)}}{(\text{waterline length (ft)})^3}$$

By this measure, the tug has a displacement-length ratio of 588 vs. 216 for the tanker. In other words, the tug is

quite heavy for its length. Typical of vessels with high displacement-length ratios (over a value of 400) are tugs, fishing vessels, and some yachts. Most slow passenger vessels have moderate displacement-length ratios (values between 200 and 300) while fast vessels generally have low displacement-length

Ship Design  
Naval Architecture  
Marine Engineering  
Program Management Services  
Systems Engineering  
Environment Services  
Combat Systems Engineering



*Since 1957- Commercial and Naval Ship Design, Detail Design and Construction Program Support, Marine Consulting, Pollution Prevention Programs*

Alexandria, VA • Arlington, VA • New York, NY • Newport News, VA • Pascagoula, MS • Pittsburgh, PA  
Bath, ME • Port Hueneme, CA • Bremerton, WA • Philadelphia, PA • San Diego, CA • Tacoma, WA

### John J. McMullen Associates, Inc.

**Corporate Headquarters**  
4300 King Street, Suite 400  
Alexandria, VA 22302  
(703) 418-0100

**Business Development Office**  
Phone: (703) 933-6690  
Fax: (703) 933-6777

Web Site: [www.JJMA.com](http://www.JJMA.com)  
Email: [Marketing@JJMA.com](mailto:Marketing@JJMA.com)

Circle 248 on Reader Service Card or visit [www.maritimereporterinfo.com](http://www.maritimereporterinfo.com)

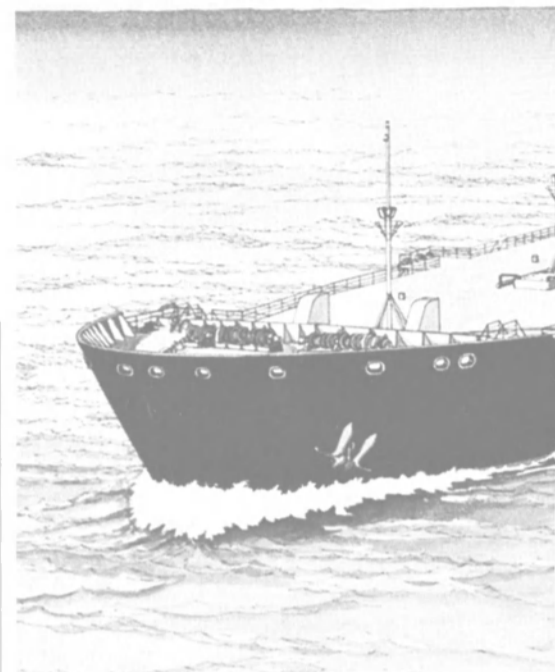

ratios (values of less than 100).

For speed-length ratios from zero to approximately 1.3, the weight of a vessel, at speed, is supported by buoyancy forces. Operating at a speed above 1.0 times the square root of the waterline length, greater speed typically means a long, slender hull. This is shown in the transatlantic liners of the 1930's such as Normandie, which has an operating speed of 29.5 knots - provided by a hull that was approximately 962 ft. (293.2 m) on the waterline; giving her a speed-length ratio of 0.95. Its ratio of length to beam was 8.7:1 and its displacement-length ratio was 76.7.

Where the weight of the hull is supported by both buoyancy and hydrodynamic forces, as in a planing hull, the hull shape is markedly different. The width of the hull relative to the length increases in order to provide more lifting area to get the hull out of the water. Typical of monohull planing boats are length to beam ratios of between 5:1 and 4:1. The hulls have significant deadrise in the bow to prevent pounding in waves. The bottom lines aft of amidships tend to be of a relatively constant shape, providing good water flow. The stern is a transom shape to provide a clean separation of the water flow. Again, the hull shape changes as the operation changes.

Figure 1 on page 27 provides some comparison between various hull shapes, sorted by displacement-length ratio.

#### What About Multi-Hulls?

Shortly after our coastal dweller modified his basic log shape, his neighbor probably lashed other timbers onto a log and pronounced his invention of a newer, better hull shape: the outrigger canoe. Since that time there have been a large number of vessels built with two or more hulls. Are two hulls better than one? Let's see what our key numbers tell us.

For low speeds, the resistance of a hull

## GMT Electronics Inc.

"Setting the Standard on the Waterfront"

171 Maine St.; South River, NJ 08882  
(732) 651-1213

Authorized Sales and Service Dealers for  
most Major Brands of Marine Electronics

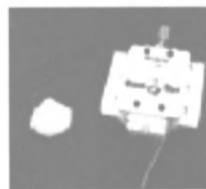

#### GSMP 2100 (R)

- Crystal Clear voice transmission
- Data transfer rates up to 56Kbps\*
- No ISP Required
- Compact Omni-Directional antenna requires no inputs from onboard sensors. Easily Installed
- Under \$3,500.00

SeaTel's Revolutionary  
Satellite Voice/Data  
Omni-Directional Antenna

#### FURUNO

#### Solid State GPS Gyro

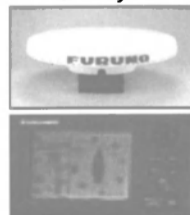

#### SC60 / SC120

- Heading information for Radar/ARPA, AIS, ECDIS, Scanning Sonar and Chart Plotter
- No mechanical parts such as gimbals or rotating meter, making compass free from Routine Maintenance or Overhaul
- Also Acts as GPS with 4 Different Display Screens

#### Complete Charting Systems

#### NOBELTEC



NetVista X Series  
Integrated Computer

- IBM's Net Vista X series All in One Computer With Radial Arm
- Ruggedized desktop, laptop, PilotPak and all-in-one systems are available
- Improving wheelhouse "situational awareness" with integration of GPS, sounder and radar on one screen
- Complete system starting at \$2,200.00

#### Custom Marine Electronics



Dual Drum Towing  
slippage alarm

- Informs operators if winch is Paying out or Hauling in
- Records total count of drum revolutions, cable payout lengths and winch operating hours
- Independent activation of Port and Starboard drum alarms
- Optional remote station Displays

For more information of these Products, Innovative Cost Saving Custom Made Products or any Marine Electronic needs, please call John Churchill or visit us on the web at [www.gmt-electronics.com](http://www.gmt-electronics.com)

Circle 341 on Reader Service Card or visit [www.maritimereporterinfo.com](http://www.maritimereporterinfo.com)



is primarily due to the frictional resistance of the water flowing past the hull. This frictional resistance is proportional to the surface area of the hull. With two hulls, a catamaran has more surface area than a monohull of the same displacement. Therefore, at low speeds, a catamaran is less efficient than a monohull. It does have greater stability however due to the spacing of the hulls. A designer may use a catamaran hull for a slow speed vessel where there is a need for greater stability or where there is a need for a large deck area.

At high speeds the catamaran design divides the weight of the vessel and wave making resistance between two demi-hulls, both of which are relatively narrow for their length. Let's take the example of a 135-ft. (41-m) catamaran with a waterline length of 115 ft. (35.2-m), a speed of 36 knots, and a full load displacement of 170 metric tons (167.3 long tons). Each demi-hull has a speed-length ratio of 3.35 and a displacement-length ratio of 54.4. The beam of the demi-hull is 9 ft. (3 m) giving a length to beam ratio of 11.7:1. Note that the hulls are long and narrow and that the weight is relatively low compared to the size of the vessel. They are also spaced far enough apart that the wave train from one demi-hull does not affect the other demi-hull. The shape of the main deck with a beam of 34 ft. (10.5-m) also gives a good layout for passenger spaces.

Like any other hull type, there are disadvantages to the catamaran configuration. The narrow shape of the demi-hulls makes for restricted access to the propulsion machinery.

The hull will be subject to slamming when the height of the seas exceeds the air gap clearance between the cross structure and the design waterline. The fine shape of the bows can cause the bow to plunge into waves rather than rise over them and the stresses induced by two demi-hulls working in a seaway can lead to structural cracking.

Lastly, the performance of the vessel is very sensitive to weight so careful mon-

itoring of weight growth is essential.

**So, What's the Perfect Hull Shape?**

The answer will be different for different operations. If you are thinking of a new vessel design or about modifying an existing one, I suggest talking to a variety of designers. Each one has their

preferences and their areas of expertise. If someone is trying to convince you that there is a break-through design that is better than anything out there, be cautious. As we have tried to show above, there is no one hull shape or type that will meet all needs.

Designers have lots of good tools to

analyze vessel performance in order to optimize hull shape for seakeeping and resistance. Talk to them and get educated about the options for hull shape and their costs. Size up those logs and pick the one that's best for you.

Circle 29 on Reader Service Card  
www.maritimereporterinfo.com

**BAE SYSTEMS/MARINE PRODUCTS**

Formerly: Singer-Kearfott; ES Marine; GEC-Marconi Hazeltine

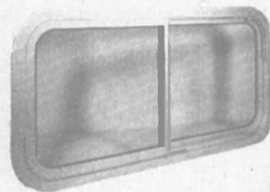

Sliding Window

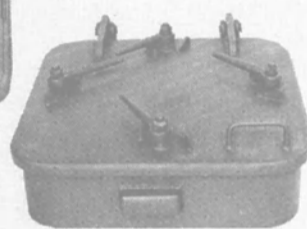

Hatch

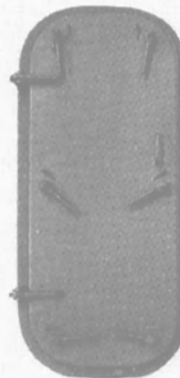

Water Tight Door

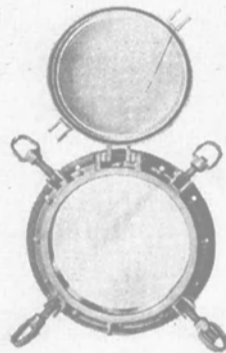

Hinged and Fixed Ports

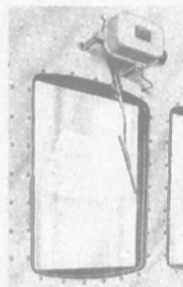

Window Wiper and Fixed Window



Clear View Screen

**WINDOWS:** heated, fixed, double sash, sliding, and crank-operated

**PORTLIGHTS:** hinged and stationary in aluminum or bronze

**WINDOW WIPERS:** heavy-duty

**DOORS:** watertight, individually dogged, or quick-acting

**HATCHES:** quick-acting or dogged

**SCUTTLES:** quick-acting or dogged

**CLEAR VIEW SCREENS**

Write for catalog:

**BAE SYSTEMS**

BAE SYSTEMS Aerospace Inc., Marine Products  
550 South Fulton Avenue, Mount Vernon, N.Y. 10550  
Telephone: (914) 664-6033 Fax: (914) 667-2311

ISO 9001 CERTIFIED

Circle 210 on Reader Service Card or visit www.maritimereporterinfo.com

**THERE IS AN ALTERNATIVE:**

**HIGH PRICES?  
LONG LEAD TIMES?  
POOR SERVICE?**

If you are currently experiencing any of these difficult and frustrating problems; you need to contact **AIRVAC MARINE SYSTEMS** to receive top quality products and service at reasonable prices.



Founded in 1970, AIRVAC, INC., has become a world leader in vacuum collection systems. AIRVAC, INC., continues its leadership role with the introduction of the easy to install and maintain Retro Fit Kit. The kit is designed to fit most vacuum toilets available on the market today. Contact us for the location of the nearest authorized AIRVAC representative in your area.

*"Where caring makes the difference."*



Rochester, IN 46975 U.S.A.  
Telephone: (574) 223-3980 Fax: (574) 223-5566 Web: www.airvac.com

Circle 202 on Reader Service Card or visit www.maritimereporterinfo.com

# Advances in CAD and CAM System Integration

Over the past 25 years CAD and CAM have become a vital part of shipbuilding. The individual tools have evolved into highly capable products of today. This

has included the change from 2-D to 3-D CAD, a dramatic increase in the level of usability (example: from batch mode to fancy 3-D GUI's) and increased func-

tionality within the tools themselves.

With the development of these tools has also come improved integration of the CAD and CAM data. While 2-D

CAD drawings were originally entered into the CAM system manually, it has now become commonplace to utilize a fully integrated product model environment from vendors such as Dassault Systems (Catia), Intergraph (ISDP), Nupas-Cadmatic, Sener (Foran) and Tribon Solutions (Tribon M1).

Even today, some current installations utilize a complete 3-D product model for the design of a system such as piping or HVAC, but then create a paper drawing to transfer data to the production (CAM) system.

CAD and CAM integration has always been a primary problem for U.S. shipbuilders. U.S. naval shipbuilders have tended to use general-purpose mechanical CAD systems such as CADDs or CATIA because of their exceptional 3-D model viewing capabilities.

### An Integrated Solution

Because these systems lacked shipbuilding CAM capabilities, they had to be combined with separate shipbuilding CAM systems such as AUTOKON or SPADES. Few options were open as to how to integrate these CAD and CAM systems, and yards have normally created the connections themselves by writing dedicated custom interfaces. These interfaces must then be maintained by the shipyard (or sub-contractor) and be modified to accommodate software upgrades or new tools.

In general European shipyards have tended to utilize shipbuilding specific CAD/CAM systems such as Tribon, Foran and Nupas. These systems provide an integrated CAD/CAM solution as part of a single system. Such monolithic systems utilize proprietary data architecture, to provide seamless links between the two systems. In this case the shipyard is tied to a single vendor and may have to compromise on the available features in one part of the system in order to have the desired features of the other part. Additionally, many shipyards implemented the sole source vendor's products while they were in the early stages of product development and were left to create many custom interfaces to other shipyard systems themselves.

Up until now, major Japanese shipbuilders have employed either their own homegrown systems such as Mitsubishi Heavy Industry's MATES or specialized shipbuilding CAD/CAM systems such as Tribon. Like their European counterparts, the Japanese put more emphasis on CAM and production than the U.S. yards, which, as mentioned, tend to emphasize model viewing.

Regardless of the type of configuration, once the shipyard finally gets all of its connections in place, little flexibility remains to adopt new, improved products or practices. In order to make

**Rotating and Speed Control Units**

**STORK-KWANT**

*Quality in Command*

Voltastraat 3, P.O. Box 23  
8600 AA Sneek Holland  
Phone: +31 (0)515 413745  
Fax: +31 (0)515 422478  
Email: kwant@stork-kwant.nl Website: www.stork-kwant.com

Circle 296 on Reader Service Card or visit [www.maritimereporterinfo.com](http://www.maritimereporterinfo.com)

**Heavy Duty Capstan Winches**

**JEAMAR WINCHES**

- Meets the Toughest Standards.
- High Starting Loads.
- Electric, air or hydraulic.
- Extensive range of sizes.
- Mountings to configure to existing foundations.

Send for our catalogue for full details!

**Jeamar Winches**

1051 Clinton Street, Buffalo, New York, U.S.A. 14206  
Toll Free: Tel: 1-877-884-8118 • Fax: 1-877-569-9909

web site: [www.jeamar.com](http://www.jeamar.com) • Email: [sales@jeamar.com](mailto:sales@jeamar.com)

JEAMAR ISO 9002 REGISTERED

Circle 247 on Reader Service Card or visit [www.maritimereporterinfo.com](http://www.maritimereporterinfo.com)



changes to a single system, a major revision to the connection architecture is normally required.

Additionally, several manual steps might be necessary to perform the actual data transfer. These environments typically don't have support for data management, putting a heavy burden on the systems user. This is especially true in the "one of a kind" production in shipbuilding, where the CAD to CAM data transfer happens often.

#### Research, Development, Sharing = Better CAD Systems

As the implementation of 3-D product modeling becomes the norm in more shipyards, the need for a flexible CAD and CAM integration solution will increase. The need for flexibility is compounded by the worldwide consolidations taking place in the industry. Acquisitions and mergers have created families of companies working together in ways that would have seemed impossible just five years ago.

The current direction from the large product model vendors is to allow an open standard format as an optional output from their product model. This is demonstrated by vendor involvement in projects such as NSRP, ISE / ESTEP. Use of open standards would support a local integrated architecture and provide data access between systems used by sister shipyards or subcontractors.

Two open-standard formats; STEP and STEP-NC are destined to compete with proprietary solid-model formats. These important standards allow

the sharing of model data between different systems and will provide a better integration of CAD and CAM.

STEP or ISO 10303 (<http://www.diffuse.org/products.html#STEP>) is a vendor neutral standard that describes how to represent (and therefore exchange) digital product information. STEP-NC or ISO 14649 ([www.step-nc.org](http://www.step-nc.org)) provides a neutral NC-programming interface to support information transfer between CAD and CAM and NC systems. Recent emphasis has been on milling operations; however further exploitation of this standard for other applications such as shipbuilding is currently underway.

There are several U.S.-based R & D projects currently underway that are intended to better integrate CAD, with the current and planned CAM systems.

The Integrated Steel Processing Environment (ISPE) is an NSRP-ASE funded research project. Headed by Northrop Grumman Ship Systems, the project goal is to create an interoperable solution that removes the dedicated link from one CAD system to one CAM system for the design and production of steel plate.

STEP Tools (Troy, NY) currently is working on an U.S. Navy, ONR funded research project to examine the technical merits of utilizing STEP-NC for manufacturing operations in the shipbuilding industry. STEP Tools will study applying STEP-NC technology to control pipe bending and cutting at Electric Boat, Quonset Point, RI.

Atlantec Enterprise Solutions (Annapolis, MD)

"Now with  
leak detection"

# THE BALLAST

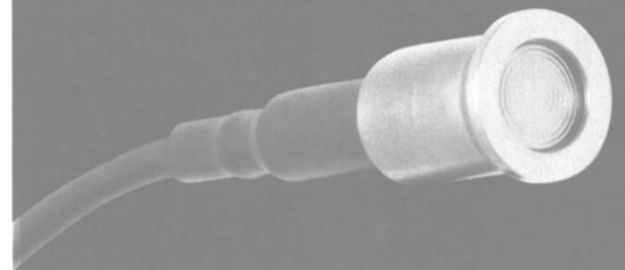

## Smart Strain Gauge Level Sensor with Generic 4-20mA Output

### Use one sensor for all shipboard liquid levels

This technology has been designed specifically for surviving the rigors of ballast tank continuous monitoring. It weighs less than 2 oz. and is constructed from 100% pure titanium.

- It's the size of your thumb
- Accuracy .25% of full scale
- 100% Titanium
- Weighs less than 2 oz.
- ABS/USCG/Lloyds approved
- FM Class 1, Div. 1 Intrinsically Safe
- Removal without tank entry
- No mercury or other contaminants
- Interfaces to your existing monitoring system
- One sensor for all shipboard liquids: fuel oil, lube oil, fresh water, black water, etc.
- Generic 4-20 mA output
- Used in 15,000 tanks worldwide

### Many Options

Call today  
for more  
information!



ELECTRONIC MARINE  
SYSTEMS, INC.  
800 Ferndale Place  
Rahway, NJ 07065

732.382.4344  
732.388.5111 fax  
emsmarcon@aol.com e-mail  
<http://www.emsmarcon.com>

Circle 225 on Reader Service Card  
or visit [www.maritimereporterinfo.com](http://www.maritimereporterinfo.com)



## SUPERIOR ENERGIES INC.

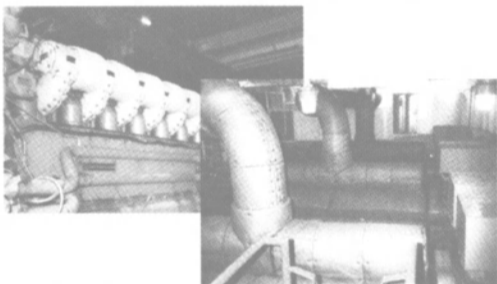

### TEMP-SET INSULATION COVERS MANUFACTURING AND CONTRACTING

Removable Reusable Temp-Set Insulation Covers,  
Manifolds, Turbos, Silencers, and complete Exhaust Systems.

ACOUSTICAL INSULATION  
ASBESTOS ABATEMENT  
TURN-KEY JOBS

Reduce engine room temperature ISO 9001  
Lower engine room noise  
Easy to assemble  
Coast Guard Compliant

Let us take care of all your  
insulation and abatement needs  
We accept MasterCard, Visa and Amex

WANT SUPERIOR QUALITY  
WANT SUPERIOR SERVICE  
CALL SUPERIOR ENERGIES INC.

# 1-800-BUY-SEI-1

P.O. Drawer 386, Groves TX 77619  
Telephone: (409) 962-8549 Fax: (409) 962-4027  
Website: [www.insulationsei.com](http://www.insulationsei.com)

Circle 299 on Reader Service Card or visit [www.maritimereporterinfo.com](http://www.maritimereporterinfo.com)

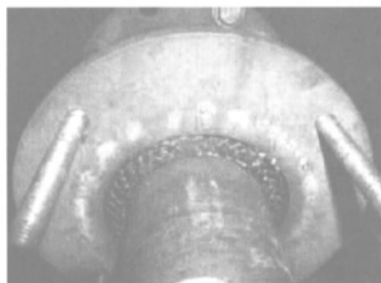

## Slade Fluid Sealing

### No Flush - No Leak Service

Simply the best!!

- UP TO 10 YRS SERVICE IN TAILSHAFTS
- VIRTUALLY LEAK FREE
- DRY BILGES MEAN FEWER HAZMAT or DISCHARGE WORRIES
- NO WEAR ON SHAFTS OR SLEEVES - SEALS WORN EQUIPMENT
- LIFETIME GUARANTEE IN VALVES
- NUCLEAR SERVICE APPROVED - ABS Type Approval Pending
- OUR GASKETS PERFORM ON STEAM CUTS & IRREGULAR FACES

Contact DELAMAR - EXCLUSIVE Distributor of Slade Products to the Marine Industry  
434-983-6104 (Phone) [www.delamar.net](http://www.delamar.net) (Internet) [info@delamar.net](mailto:info@delamar.net) (E-mail)

Circle 303 on Reader Service Card or visit [www.maritimereporterinfo.com](http://www.maritimereporterinfo.com)

PRELIMINARY NOTICE - UNRESERVED PUBLIC AUCTION

# Cheboygan

## Michigan



**A partial list to date includes:**

**CABLE LAYING EQUIPMENT:** Moran Sled.

**15- BARGES:** Marcus 100 x 30 x 6 Ft Steel Spud, Mobro 2001 180 x 52 x 11 Ft 923 Ton Steel Spud, Mobro 2000 180 x 52 x 11 Ft 933 Ton Steel Deck, Sam 2 90 x 50 x 7 Ft 297 Ton Steel Spud, 2- 2000 195 x 40 x 12 Ft 820 Ton Steel Material, 2- 2001 195 x 40 x 12 Ft 786 Ton Steel Material, 120 x 33 x 6 Ft Spud, 100 x 24 x 4 Ft Deck, 2- 96 x 28 x 9 Ft 193 Ton Steel Dump, 38 x 14 x 75 Ft 10 1/2 Ton Steel, 38 x 14 x 3 Ft, M2 47 x 16 x 3 Ft 24 Ton Steel.

**14- MARINE - COMMERCIAL VESSELS: Tug Boats;** Champion 63 x 23 x 9 Ft 125 Ton, Joe Van 49 x 15 x 7 Ft 32 Ton, Nancy Anne 54 x 20 x 8 Ft 73 Ton, Ray Durocher 42 x 12 x 5 Ft 20 Ton. **Push Boats;** 1993 Michael V 20 x 8 x 2 Ft 4.45 Ton, Monark 26 x 9 x 2 Ft Alum Tri-Hull Crew. **Skiff/Work Boats;** Lowe 10 x 2 Ft, Monark 21 x 7 x 1 Ft Alum Tri-Hull, Sea Ark 21 Ft Alum, Sea Ark 18 x 5 Ft Alum Tri-Hull, Sea Nymph 16 x 4 Ft Alum Tri-Hull, Sea Nymph 16 Ft Alum Skiff. **Crew Boats;** Monark 21 x 7 x 1 Ft Alum, Timmy V 12 Passenger.

**MARINE EQUIPMENT:** Quantity Of Anchor Buoys, 2- Mesotech 971- Type Sonar Heads, Garmin GPSMAP180 GPS/Chart Plotter, Hydrotrac HT97001 Precision Survey Echo Sounder, Lucker CPM100 Cable Puller, Mesotech MS940 Sonar Power Supply, Mesotech MS900 Sonar Receiver, Raytheon DE-719C Faithometer, Swoffer Instruments 2100-LX Current Velocity Transducer, 5- Trimble DSM212L GPS Units.

**BARGE EQUIPMENT:** American 2 Drum Winch, Clyde 2 Drum Winch, Domestic 2 Drum Winch, 4- Ingersoll-Rand HU Single Drum Air Operated Winch, Sasgen SD40 Single Drum Winch, 2- Single Drum 11,000 Lb Winch, 2 Drum Winch.

**Other equipment in this sale includes:** Rough Terrain Cranes, Conventional Cranes, Crane Attachments, Wheel Loaders, Skid Steer Loaders, Hydraulic Excavators, Cable Laying Equipment, Compaction Equipment, Truck Tractors, Flatbed Trucks, Step Deck Trailers, Van Trailers, Office Trailers, Telescopic Forklifts, Forklifts, Snow Equipment And Much More.

Wednesday, **October 9, 2002** 8:00 am

**Sale Site:** 958 North Huron Street, Cheboygan, Michigan 49721

**Site Fax:** 815.942.8053

CALL FOR A FREE BROCHURE

# 815.941.6400

RBA  
NYSE

## rb RITCHIE BROS. Auctioneers

FOR INFORMATION ON OTHER RITCHIE BROS. AUCTIONS PLEASE CONTACT -  
TEL: 402.421.3631 OR 1.800.663.8457 • FAX: 402.421.1738

rb**au**ction.com

**UNRESERVED - EVERYTHING SELLS TO THE HIGHEST BIDDER**

PRELIMINARY NOTICE - UNRESERVED PUBLIC AUCTION

# Jacksonville

## Florida



**A partial list to date includes:**

**BARGES:** Mobro 130 7 x 45 x 120 Ft Spud, 1202ABS 150 x 45 Ft Spud, 2000 50 x 180 Ft Work, 30 x 120 Ft Deck, 2- 8 x 32 Ft Portable Work, 8 x 20 Ft Work, 2000 GBS 50 x 185 x 12 Ft Deck.

**MARINE - COMMERCIAL VESSELS:** Betty D Crew Boat, Gladys P 8 x 26 Ft Crew Boat, Jeff Boat 1613 10 x 35 x 195 Ft Material Deck Barge, Meaghan Beth 9 x 22 x 52 Ft Tug Boat, Michael Van 24 Ft 6 In. x 65 Ft Tug Boat, Mobro 35 x 195 Ft Work Barge, Red Poll 18 x 48 Ft Push Boat, Sea Ark MV2472 7 x 20 Ft Work Boat, Troy 5 x 13 x 29 Ft Push Boat.

**BARGE EQUIPMENT:** 2- Smatco Clyde Frame 7 3 Drum Deck Winch.

**MARINE EQUIPMENT:** 2- 4 Ft Round Mooring Buoys, Dawforth 10,000 Lb Boat Anchors, 10,000 Lb Boat Anchors.

**CONVENTIONAL CRAWLER CRANES:** American 9270 165 Ton, American 7260 100 Ton, 2- American 5299 50 Ton.

**CONVENTIONAL TRUCK CRANE:** American 4450 40 Ton, American 395BT 30 Ton.

**ROUGH TERRAIN CRANES:** 1993 P & H Century 150, P & H Omega 40 Ton, P & H Omega 20 Ton.

**HYDRAULIC TRUCK CRANE:** P & H T300 30 Ton, Grove TMS300 30 Ton, Lorrain MC320.

**CRANE ATTACHMENTS:** 1996 Anvil 19,000 Lb 4.5 Cy Clamshell Bucket, Hawco R300 3 Cy Orange Peel Bucket, Hawco 36 In. Rock Tong, Hawco 3 Cy Orange Peel Bucket, 8 Cy Clamshell Bucket, 2- 4 Ft Orange Peel Bucket, 3- 4 Cy Clamshell Bucket, 2- 3 Cy Clamshell Bucket.

**Other equipment in this sale includes:** Wheel Loaders, Skid Steer Loaders, Mini Excavators, Compaction Equipment, Flatbed Trucks, Office Trailers, Telescopic Forklifts, Forklifts, Scissorlifts, Manlifts, Snow Equipment And Much More.

Auction Business License #AB-0000303

Principal Auctioneer - Johnny Paiz Jr. #AU0002627

Friday, **October 11, 2002** 8:00 am

**Sale Site:** 1720 E Adams St, Jacksonville, FL, 32202

**Site Fax:** 863.420.2447

CALL FOR A FREE BROCHURE

# 863.420.9919



and production tools are headed towards a higher level of interoperability, which will lead to greater flexibility in upgrading and working with other shipyards, subcontractor, and suppliers.

*The preceding article was written by Bryan Miller and Paul Rakow. Atlantec would like to thank all of the shipyard personnel that contributed to this article.*

currently has an ONR funded research project to determine the feasibility of an open connector architecture that decouples CAD and CAM software applications. The goal of this is to provide greater flexibility in selecting best of breed CAD and CAM system and simplify the information infrastructure typically required to support CAD and CAM connections. Atlantec-es is working with Electric Boat, Quonset Point, RI in the HVAC fabrication area and Howaldtswerke-Deutsche Werft, Kiel Germany in the plate production and pipe bending areas.

While there have been major improvements in the tools available on the market today, these projects all offer a glimpse of the future for the shipbuilding industry. Computer aided design

*Atlantec Enterprise Solutions is a software and consulting company based in Annapolis, Md. and Hamburg Germany. Founded in 1999, Atlantec-es develops and markets its Topgalant shipbuilding software system to the marine industry.*

*The core competencies of Atlantec-es are data management, production engineering and shipbuilding. Customers include Electric Boat, NASSCO, ONR, NSWC, ABS, and Howaldtswerke-Deutsche Werft. Atlantec-es is owned by management. The company's two senior managers are Bryan J. Miller, President and Dr. Thomas Koch, Managing Director.*

“Now with  
leak detection” **THE  
RADAR**

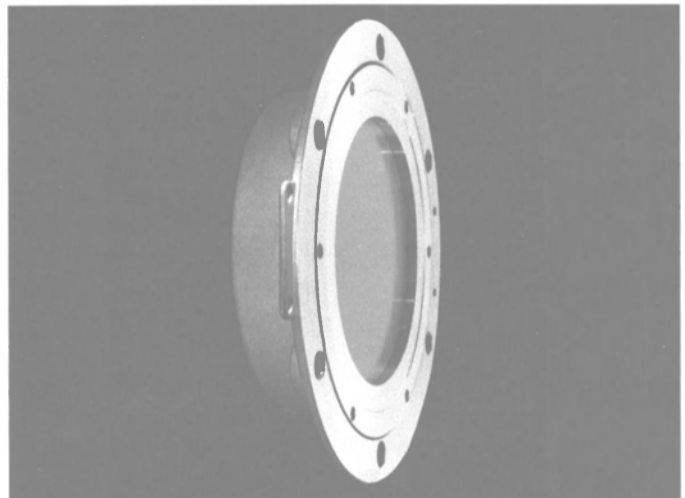

**Smart Radar Level  
Sensor with Generic  
RS485 Output**

*The first flat array antenna for liquid tank gauging. This software driven array allows for each sensor to remotely configure itself for the type of product as well as the structural characteristics within each tank. It is completely self-diagnostic and is factory calibrated using a laser interferometer to .1mm. It is designed for the harshest environments and can be provided in a high temperature version to 385°F. It is intrinsically safe with Class 1, Div. 1, Group D & C approvals. As a smart sensor, all processing calculations and software are resident in the device itself, only a high level generic data output, i.e., RS485 (or others on request) is sent to the cargo control area.*

**Options:**

- Multiple alarm set-points
- Temperature • PV Pressure • I.G. Pressure
- Tank Management Software
- Automated draft and trim

**Call today  
for more  
information!**



ELECTRONIC MARINE  
SYSTEMS, INC.  
800 Femdale Place  
Rahway, NJ 07065

732.382.4344  
732.388.5111 fax  
emsmarcon@aol.com e-mail  
http://www.emsmarcon.com

**SHIPBOARD  
ENGINEERING  
& TESTING**



**Dayton T. Brown, Inc.** provides complete engineering and test services for shipboard systems design, reliability and maintainability improvement, technology insertion and qualification testing to specifications such as MIL-S-901 Shock, MIL-STD-167 Vibration, MIL-STD-461 EMI and MIL-STD-2036 test requirements.

**Dayton T. Brown, Inc.** has over 50 years of engineering & testing experience and affords you a complete range of dynamic, environmental, atmospheric and electromagnetic testing facilities as well as engineering consulting services in a centralized location.

For a complete facility brochure or technical information concerning any test requirement, contact:

**Dayton T. Brown, Inc.**

1175 Church Street, Bohemia, NY 11716-5031 USA  
Please direct all inquiries to: 800 TEST-456 • email: test@dtb.com  
Visit our web site at: www.dtb.com



# Precision Ship-Handling Writ Large

Story and Photos by Alan Haig-Brown

On the Elbe River, the famous port of Hamburg's Nautical Institute had its final intake this year due to a shortage of prospective students. From now on it will be known as the Hamburg Institute for Ship Handling and Simulation, but for many years it sent highly trained young people to sea. Some of those, after gaining years of deep sea experience, returned to Hamburg to become river and docking pilots. The Port has two pilot stations and two pilotage authorities. The Harbor Pilots (Hafenlot-senbrüderschaft), of which there are about 45, work from a beautiful brick building complete with clock tower on a point at the entrance to the port on the south side of the river where most of the docks are located. The river pilots' association (Lotsenbrüderschaft Elbe), which includes the sea pilots and has about 240 members, are located just down and across the river in a large house barely distinguishable from its luxurious neighbors in the tonier part of this very beautiful city.

Entering the Hanseatic port of Hamburg from the sea is a three-stage proposition. As the ships come into the German Bight from the North Sea, they contact a pilot from the sea station, which is the recently launched 164 x 74-ft. (49.9 x 22.5-m) SWATH station ship Elbe. The pilots are boarded from a (7.5-m) pilot boat or a (25-m) version of the

SWATH that has effectively done away with the need for and use of helicopters for boarding unless specifically requested by the ship. Forty n.m. from the pilot ship and just inside the estuary, on the north shore where the Kiel Canal connects from the Baltic Sea, a pilot boat brings a river pilot out to exchange places with the sea pilot. This pilot then takes the ship the remaining 36 miles on up the river to the port entrance where one or more docking pilots take over.

Out bound the reverse order is followed. Just ahead of the Easter weekend last March 27, one of the harbor pilots handed the 3,764 teu containership Teng He over to river pilot Capt. **Jens Heesch**, who had boarded from a launch in front of the River Pilot station. Although the port is 60 miles from the North Sea some parts of it are below sea level. With 15-ft. tides common, the river typically reverses its flow to over three knots on a flood tide. A strong westerly blowing in from the North Sea can add another six feet to these tides and frequently threatens flooding in the lower port areas. On this March afternoon with the full moon just one day away, the tide is flooding just under two knots and the ship is making 12.2 knots over the bottom as it heads down river. The north shore, with its sumptuous homes, many of which were built over the centuries by Hamburg shipping magnates, is lined with swimming beaches and marinas, both of which require the



Hanjin Praha's Captain **Jens Urohn** stands between Hamburg docking pilots **Jan Venghaus** and **Kai Supper**.  
photo credit: **Alan Haig-Brown**

pilots' care. Especially the swimming beaches in summer, says Heesch, as the ship's effect in surging and sucking water off the beach can cause a dangerous situation. It requires precision to move a large ship through water while allowing for the presence of a fragile human body in the same system. Opposite the huge Airbus fabrication facility on the south shore, Capt. Heesch calls the Port of Hamburg vessel traffic manager center located in the Harbor Pilot's building, to report that he is leaving the port's jurisdictional area. Then he checks in with the Brunsbüttel Vessel Traffic System which is operated from a state-of-the-art facility at the mouth of the Kiel Canal Brunsbüttel reports on the river traffic as Heesch brings the Teng He on course with the aide of the first of a series of leading or range lights that aide ships in maintaining mid channel for the whole length of the lower river.

Also on this stretch of the river at the lower end of Hamburg's residential suburbs, is the restaurant Schulauer Fahrhaus where a maritime flag pole displays a Chinese flag and huge loud speakers play the Chinese national anthem to honor the registry of the Teng He. The COSCO Container Line vessel's Captain **Yang Renzhong** walks out on the starboard bridge wing to wave his appreciation of the gesture. "Sometimes the captains show a little tear," says Heesch of the tradition marking a ship's entrance and exit from Hamburg.

With a number of years in deep sea service himself, Heesch is sympathetic to the emotions of the visiting captains. Following his sea duty, he has been 18 years in the Elbe pilotage, with all but the last of those spent as a sea pilot. Most of the pilots working in the river between Hamburg and Brunsbüttel have spent time in the physically more demanding leg in from the German Bight. Typically new pilots train for both the sea leg and the estuary but then start at sea. When they make the move inside, the pilots take an update to the training for the transition to the river.

An hour after leaving the Port of Hamburg controlled area, the Teng He passes a Dow Chemical plant that takes advantage of huge reserves of underground salt in the area. This is one of the few shipping docks on the lower river. Once clear of the plant, Heesch asks for another 10 revolutions on the main engine to bring the ship up to its 16-knot maneuver speed. The river is widening now but the navigation channel is maintained at a 820 x 989-ft. (250 to 300-m) width from Hamburg to Brunsbüttel with the depth dredged in a few spots as required to maintain a 114-ft. (14.4-m) low water depth allowing a 42-ft. (12.8-m) maximum ship draft on low water and 49-ft. (15.1-m) draft on high water. With the tide still flooding and the Teng He drawing 37 ft. (11.3 m), Heesch keeps the speed in check to avoid any possibility of "squat" as the ship passes over some



Docking pilots station in the Port of Hamburg.

photo credit: **Alan Haig-Brown**

of the shallower areas. As the tide reaches high water slack and the ship reaches slightly deeper water 20 minutes later, he increases the vessel's speed to 17.5 knots just under its full sea speed. The pilot's years of deep sea experience are revealed as he tells not only of ocean crossings, but of watching other pilots work in the tides and currents on the Congo River and grounding a ship just inside Vancouver's Lions Gate Bridge.

The land along the lower river is uniformly flat with few villages on its flood prone expanse, but a few miles above Brunsbüttel, the mouth of the smaller Stor River is protected by a flood gate. Over the grasslands the superstructure of a small coaster containership rises from the dry-dock at the Peterswerft Wewelsfleth GmbH, shipyard that represents the long tradition of German shipbuilding. While suffering from lower cost Asian competition, the yards are active in specialized ships. But few large containerships like the Teng He are built here now. The 905 x 106-ft. (276 x 32.3-m) Teng He was built in Germany by Bremer Vulkan Ag in 1994. It was a time of busy yards when owners, anxious for new tonnage, were not so conservative on price.

At 3:30 p.m., merely three hours after leaving the dock at Hamburg, the ship is slowed for the approaching pilot boat that is coming out from the Brunsbüttel station. The widening expanse of the estuary is covered with a low mist over both the land and the water, "It can be very rough here and we usually have to make a lee for the pilot boat," explains Heesch, "But today a high pressure has brought this mist and calm seas."

The station at Brunsbüttel is the hub of the Elbe pilot area. With approximately 100 sea pilots stationed here, a similar number of river pilots come down river and then await a ship back up river while another 50 pilots are charged with bringing ships into the small port of Cuxhaven to the west on the south shore just inside entrance to the estuary. They also move ships from there to Brunsbüttel and the entrance to the Kiel Canal.

After handing off the ship to the pilot that will take it to sea, Heesch makes his way to the pilot boat. Like many foreign ships sailing the area, the Teng He also had a North Sea pilot on board. These private pilots hire out to move the ships between port pilot authorities such as those at Felixstowe in the U.K., Amsterdam in the Netherlands and Antwerp, where the Teng He was bound, in Belgium.

At the Brunsbüttel pilot station, Capt. Heesch would await his turn in rotation to take a ship back up river. The old station building is a sentimental favorite with the pilots in spite of having lost its popular cafe, which helped pass time between ships. It is scheduled to be

replaced with a modern building that will reflect the contemporary design of the Vessel Traffic Center (VTC) located just across the smaller of two entrances to the Kiel Canal on a piece of land between the two locks. Built in 1895, the Kiel Canal connecting the North and the Baltic Seas, is more properly named the Nord-Ostsee Kanal. As there is virtually no tide in the Baltic and large tides on

the North Sea, the canal gates are designed to protect the land around the canal from flooding, manage the drainage of water pumped from the land and lift or lower ships as is required. Before the opening of land routes to Eastern Europe from the west, the canal carried many ships to those countries. Now it is kept busy with a growing local trade of coasters taking containers and

## SMM • Germany Report

general cargo to and from the large central ports of Western Europe. It is also not uncommon to see a partially finished fishing vessel or tug being towed from an eastern shipyard to a western yard for fitting out.

The federally managed Brunsbüttel VTC on the point of land between the canal's two locks, has as its responsibility an area that extends up to the locks

### Marine Consultancy & Engineering

**Specialist Skills and Expertise**

- Offshore
- Ships for special service
- Research & Development



Please See Us at SMM, Hall 1, Stand No. 1104

# Shiptech

Denmark

**Project Development & Contract Design** 1.

**Verification, Detailed Design & Documentation** 2.

**Inspection & Survey** 3.

Shiptech A/S  
 Slotsmarken 17  
 DK-2970 Hørsholm  
 Phone: +45 45 76 42 10  
 Fax: +45 45 76 42 20  
 shiptech@shiptech.com  
 www.shiptech.com

**Circle 291 on Reader Service Card  
or visit [www.maritimereporterinfo.com](http://www.maritimereporterinfo.com)**



DO YOU HAVE  
A COWBOY  
ON BOARD?

Cowboys are renowned for their accurate roping abilities. If every vessel had a cowboy on board, mooring would be simple.

For those of you who are not cowboys, we have the Restech PLT Mooring 75. This durable, easy to use pneumatic line thrower makes accurate mooring simple. Even in heavy side winds, the aim of the Restech PLT Mooring 75 is extremely accurate up to 90 meters. The Restech PLT uses a compressed air propellant, so there are no flames or sparks, making this the perfect mooring device for tankers and cruise ships. *Contact us today for more information.*



Visit [www.restech.no](http://www.restech.no) for a complete line of rescue and mooring line throwers

**RESTECH NORWAY AS**

PO Box 624    Tel: +47 75 58 52 63  
 N-8001 Bodo    Fax: +47 75 58 52 64  
 Norway    E-mail: [restech@restech.no](mailto:restech@restech.no)

**Circle 281 on Reader Service Card  
or visit [www.maritimereporterinfo.com](http://www.maritimereporterinfo.com)**

# THE SEA SWITCH TWO

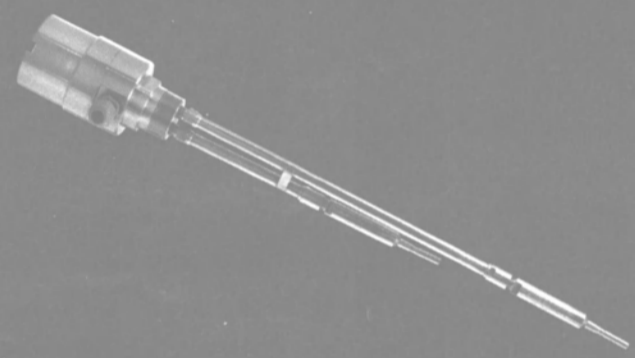

## Smart Electronic Level Switch with No Moving Parts

The Sea Switch Two was designed and patented for all tank applications. The Sea Switch Two offers a reliable solution for liquid level detection and control for cargo, ballast, and storage tanks, without any moving parts.

The Sea Switch Two uses a fully static system that is based on the propagation of an acoustic wave into a metallic rod. A piezo-electric sensing element produces a wave along the rod. As the liquid reaches the sensing element the oscillation stops and the alarm is activated.

The Sea Switch Two sensor detects high, high-high, or low level in any liquid with an alarm output given by a dry contact or current loop change 6-18 mA.

- Easy installation • Self-test built-in
- Fully static system – no moving parts

Call today  
for more  
information!

**EMS**

ELECTRONIC MARINE SYSTEMS, INC.  
 800 Ferndale Place  
 Rahway, NJ 07065

732.382.4344  
 732.388.5111 fax  
[emsmarcon@aol.com](mailto:emsmarcon@aol.com) e-mail  
<http://www.emsmarcon.com>

**Circle 227 on Reader Service Card  
or visit [www.maritimereporterinfo.com](http://www.maritimereporterinfo.com)**

# NautiCast Offers AIS Solution



Vienna, Austria-based NautiCast Schiffsnavigationssysteme specializes in the development and distribution of refined AIS navigation aids, catering for both the commercial and leisure ship-

ping industries as well as ports and VTS centers. The core product of the X-Pack range is the X-Pack DS AIS-Transponder, a product literally designed to anticipate not only today's, but also tomorrow's requirements of an AIS in the maritime industry. The X-Pack DS was developed with NautiCast and is assem-

X-Pack DS AIS from NautiCast

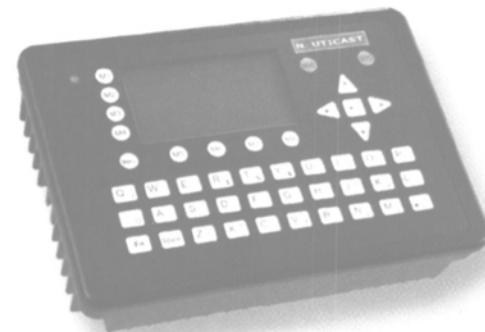

## The Blue Ribbon Filters

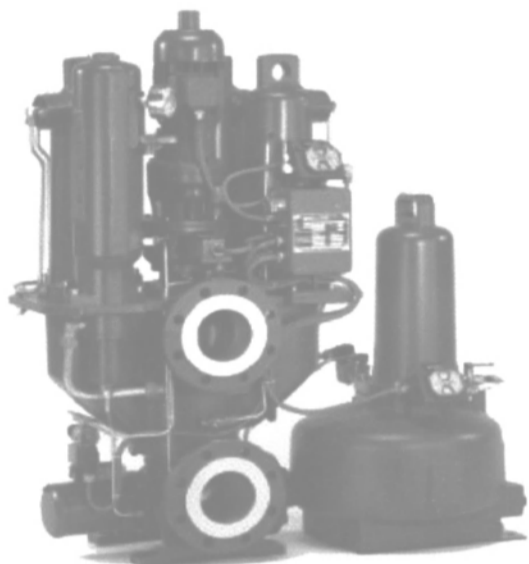

For over 50 years, BOLLFILTERS have improved the efficiency and prolonged the life of ships' vital equipment throughout the world.



### X-Pack DS — Technical Features include:

- All functions integrated into a single unit
- Integrated VHF transmitter and receiver
- Integrated GPS receiver
- Integrated power supply
- Integrated alphanumeric display

bled to ISO 9001 Standard by Siemens AG Austria.

The X-Pack DS AIS-Transponder automatically and continuously broadcasts and receives static, dynamic and voyage related ship data and exchanges it with other AIS equipped vessels and shore stations within VHF range.

Not only the technical functionality, but also the straightforward operation and compact design — measuring just 280 x 200 x 60 mm and weighing only 2,500 grams — the NautiCast Transponder was designed with the maritime industry in mind. NautiCast have tailored the trim, all in one unit with integrated alphanumeric keyboard to the limited space available in ships bridges today. The X-Pack DS not only promises to spare precious space once installed, its plug and play design ensures that installation times are kept down to a minimum. The X-Pack DS interfaces with existing NMEA compatible equipment and sensors thereby ensuring problem free retrofitting and also allows connection to PCs, notebooks, radar systems, ECDIS and Voyage Data Recorders.

NautiCast has already gained field experience on Austria's inland waterways. Its portable and riverside AIS-Transponders were chosen to supply the official European Community AIS testing area for River Information Services on the Danube. In the course of this project, NautiCast was called upon to develop a portable AIS-Transponder unit, which is currently given to ships free of charge on loan by the Austrian Supreme Shipping Authority, and remains on board during the ship's journey through the Austrian stretch of the Danube testing area.

Circle 28 on Reader Service Card  
[www.maritimereporterinfo.com](http://www.maritimereporterinfo.com)

Boll Filter Corporation  
[www.bollfilter.com](http://www.bollfilter.com)

East Granby, CT 800-910-2655  
[boll@bollfilterusa.com](mailto:boll@bollfilterusa.com)

Circle 213 on Reader Service Card or visit [www.maritimereporterinfo.com](http://www.maritimereporterinfo.com)

## GLOBAL BUNKER SERVICE

24 Hours Supplying:

- Fuel Oil
- MDO, MGO
- Marine Lubricants

Fixed Price Agreements

Offices Around the Globe

DENMARK  
Phone: +45 98 12 72 77  
E-mail: [owbunker@owbunker.dk](mailto:owbunker@owbunker.dk)

SWEDEN  
Phone: +46 8 440 46 90  
E-mail: [owsw@owbunker.se](mailto:owsw@owbunker.se)

GERMANY  
Phone: +49 40 32 55 900  
E-mail: [hamburg@owbunker.de](mailto:hamburg@owbunker.de)

NETHERLANDS  
Phone: +31 107 891 111  
E-mail: [owbunker@owbunker.nl](mailto:owbunker@owbunker.nl)

LATVIA  
Phone: +45 98 12 72 77  
E-mail: [owbunker@owbunker.dk](mailto:owbunker@owbunker.dk)

ESTONIA  
Phone: +45 98 12 72 77  
E-mail: [owbunker@owbunker.dk](mailto:owbunker@owbunker.dk)

ICELAND  
Phone: +45 70 20 40 49  
E-mail: [owicebunker@owicebunker.com](mailto:owicebunker@owicebunker.com)



UK  
Phone: +44 1753 48 33 00  
E-mail: [owbunkersuk@owbunker.com](mailto:owbunkersuk@owbunker.com)

GREECE  
Phone: +30 104 28 4455  
E-mail: [piraeus@owbunker.gr](mailto:piraeus@owbunker.gr)

SINGAPORE  
Phone: +65 6398 1250  
E-mail: [owbsin@owbunker.com.sg](mailto:owbsin@owbunker.com.sg)

SOUTH AFRICA  
Phone: +27 21 911 11 23  
E-mail: [owbunker@mweb.co.za](mailto:owbunker@mweb.co.za)

# O.W. BUNKER

[www.owbunker.com](http://www.owbunker.com)  
E-mail: [owbunker@owbunker.com](mailto:owbunker@owbunker.com)



Circle 272 on Reader Service Card or visit [www.maritimereporterinfo.com](http://www.maritimereporterinfo.com)

## SMM • Germany Report

of the shallower areas. As the tide reaches high water slack and the ship reaches slightly deeper water 20 minutes later, he increases the vessel's speed to 17.5 knots just under its full sea speed. The pilot's years of deep sea experience are revealed as he tells not only of ocean crossings, but of watching other pilots work in the tides and currents on the Congo River and grounding a ship just inside Vancouver's Lions Gate Bridge.

The land along the lower river is uniformly flat with few villages on its flood prone expanse, but a few miles above Brunsbüttel, the mouth of the smaller Stor River is protected by a flood gate. Over the grasslands the superstructure of a small coaster containership rises from the dry-dock at the Peterswerft Wewelsfleth GmbH. shipyard that represents the long tradition of German shipbuilding. While suffering from lower cost Asian competition, the yards are active in specialized ships. But few large containerships like the Teng He are built here now. The 905 x 106-ft. (276 x 32.3-m) Teng He was built in Germany by Bremer Vulkan Ag in 1994. It was a time of busy yards when owners, anxious for new tonnage, were not so conservative on price.

At 3:30 p.m., merely three hours after leaving the dock at Hamburg, the ship is slowed for the approaching pilot boat that is coming out from the Brunsbüttel station. The widening expanse of the estuary is covered with a low mist over both the land and the water. "It can be very rough here and we usually have to make a lee for the pilot boat," explains Heesch, "But today a high pressure has brought this mist and calm seas."

The station at Brunsbüttel is the hub of the Elbe pilot area. With approximately 100 sea pilots stationed here, a similar number of river pilots come down river and then await a ship back up river while another 50 pilots are charged with bringing ships into the small port of Cuxhaven to the west on the south shore just inside entrance to the estuary. They also move ships from there to Brunsbüttel and the entrance to the Kiel Canal.

After handing off the ship to the pilot that will take it to sea, Heesch makes his way to the pilot boat. Like many foreign ships sailing the area, the Teng He also had a North Sea pilot on board. These private pilots hire out to move the ships between port pilot authorities such as those at Felixstowe in the U.K., Amsterdam in the Netherlands and Antwerp, where the Teng He was bound, in Belgium.

At the Brunsbüttel pilot station, Capt. Heesch would await his turn in rotation to take a ship back up river. The old station building is a sentimental favorite with the pilots in spite of having lost its popular café, which helped pass time between ships. It is scheduled to be

replaced with a modern building that will reflect the contemporary design of the Vessel Traffic Center (VTC) located just across the smaller of two entrances to the Kiel Canal on a piece of land between the two locks. Built in 1895, the Kiel Canal connecting the North and the Baltic Seas, is more properly named the Nord-Ostsee Kanal. As there is virtually no tide in the Baltic and large tides on

the North Sea, the canal gates are designed to protect the land around the canal from flooding, manage the drainage of water pumped from the land and lift or lower ships as is required. Before the opening of land routes to Eastern Europe from the west, the canal carried many ships to those countries. Now it is kept busy with a growing local trade of coasters taking containers and

general cargo to and from the large central ports of Western Europe. It is also not uncommon to see a partially finished fishing vessel or tug being towed from an eastern shipyard to a western yard for fitting out.

The federally managed Brunsbüttel VTC on the point of land between the canal's two locks, has as its responsibility an area that extends up to the locks

## Marine Consultancy & Engineering

**Specialist Skills and Expertise**

- Offshore
- Ships for special service
- Research & Development

Please See Us at SMM, Hall 1, Stand No. 1104

**Project Development & Contract Design** 1.

**Verification, Detailed Design & Documentation** 2.

**Inspection & Survey** 3.

ShipTech A/S  
Slotsmarken 17  
DK-2970 Hørsholm  
Phone: +45 45 76 42 10  
Fax: +45 45 76 42 20  
shiptech@shiptech.com  
www.shiptech.com

Circle 291 on Reader Service Card  
or visit [www.maritimereporterinfo.com](http://www.maritimereporterinfo.com)

## DO YOU HAVE A COWBOY ON BOARD?

Cowboys are renowned for their accurate roping abilities. If every vessel had a cowboy on board, mooring would be simple.

For those of you who are not cowboys, we have the Restech PLT Mooring 75. This durable, easy to use pneumatic line thrower makes accurate mooring simple. Even in heavy side winds, the aim of the Restech PLT Mooring 75 is extremely accurate up to 90 meters. The Restech PLT uses a compressed air propellant, so there are no flames or sparks, making this the perfect mooring device for tankers and cruise ships. Contact us today for more information.

Visit [www.restech.no](http://www.restech.no) for a complete line of rescue and mooring line throwers

---

**RESTECH NORWAY AS**

PO Box 624    Tel: +47 75 58 52 63  
N-8001 Bodø    Fax: +47 75 58 52 64  
Norway        E-mail: [restech@restech.no](mailto:restech@restech.no)

Circle 281 on Reader Service Card  
or visit [www.maritimereporterinfo.com](http://www.maritimereporterinfo.com)

# THE SEA SWITCH TWO

## Smart Electronic Level Switch with No Moving Parts

The Sea Switch Two was designed and patented for all tank applications. The Sea Switch Two offers a reliable solution for liquid level detection and control for cargo, ballast, and storage tanks, without any moving parts.

The Sea Switch Two uses a fully static system that is based on the propagation of an acoustic wave into a metallic rod. A piezo-electric sensing element produces a wave along the rod. As the liquid reaches the sensing element the oscillation stops and the alarm is activated.

The Sea Switch Two sensor detects high, high-high, or low level in any liquid with an alarm output given by a dry contact or current loop change 6-18 mA.

- Easy installation • Self-test built-in
- Fully static system – no moving parts

Call today for more information!

E M S

ELECTRONIC MARINE SYSTEMS, INC.  
800 Ferndale Place  
Rahway, NJ 07065

732.382.4344  
732.388.5111 fax  
[emsmarcon@aol.com](mailto:emsmarcon@aol.com) e-mail  
<http://www.emsmarcon.com>

Circle 227 on Reader Service Card  
or visit [www.maritimereporterinfo.com](http://www.maritimereporterinfo.com)

## SMM • Germany Report

from a point just to the sea side of the station and then up river to the western boundary of the Port of Hamburg. Another station at Cuxhaven, manages the outer reaches of the estuary. The first radar system was installed on the river in the early 1960s. This new and more comprehensive facility was opened in 1994.

On the Elbe River between Brunsbüttel and Hamburg, six radar masts monitor the whole 30 n.m. of river. These masts feed data by wire and microwave to the center where they show on screens with chart representations. On screen, vectors show the direction and speed of each ship. The river channel is marked as is its center line and buoys. On a clear

day the station is staffed by two operators and a chief. Ten video monitors over the chief's desk display the whole river area. Each of these representations can be brought down and displayed on a desk console. VHF contact is maintained with all ships in the system and an hourly general broadcast gives an updated notices for mariners on obstruc-

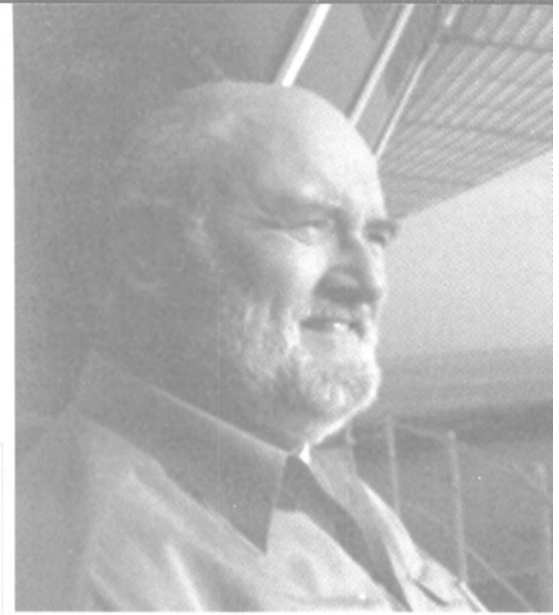

tions, visibility, tides, anchored ships, dredging and other such changeable data. In an interesting cooperation with the pilots, foggy weather with visibility less than 2,000 m will bring from two to eight pilots on duty at another bank of consoles. Their job is to work with their colleagues on board the ships to let them know their ship's precise location in relation to the channel center line. If the ship is wandering in the channel the shore pilot can inform the ship pilot who retains responsibility for final decision making. The system has the strong support of the pilots and shipping community as it means that the river can stay open to traffic in virtually all weather conditions. While it is making the pilot's life easier, it has huge economic benefit in keeping a river port competitive for time sensitive modern cargo ships.

As the sun set over the wide estuary at Brunsbüttel, the launch took three pilots out to meet three ships coming in line from sea. When the Elbe River pilot, **Christian Thiele**, boarded the second ship, the Hanjin Praha he met a German Captain **Jens Urohn** on the bridge. Urohn was returning home to Germany in command of the ship that he had taken out of the Hanjin Heavy Industries shipyard in Pusan, Korea in November 2001. The first of a series of five built for German investors and chartered back to Hanjin, the new ship is managed by Reederei F. Laeisz G.M.B.H. of Rostock, Germany. The 925-ft. (282.1 m) ship carries a 105-ft. (32.2-m) beam and

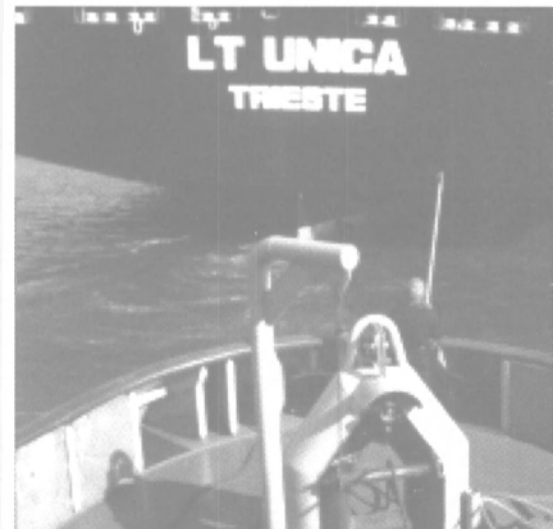

Tug Bugsier 17 puts a line up to the stern of containership LT Unica in the Port of Hamburg.  
photo credit: Alan Haig-Brown

FOR SOME VERY GOOD REASONS  
THE HAMMAR H2O  
HYDROSTATIC RELEASE UNIT IS

# No.1

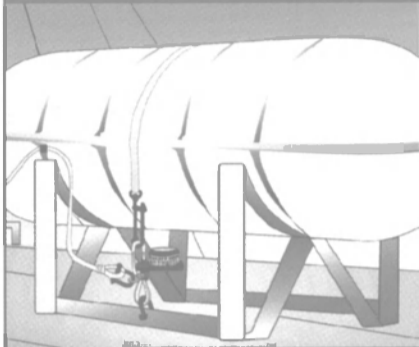

Hammar H20 secured to liferaft cradle and attached to liferaft lashing with sliphook. Painter line shackled to weaklink and strong rope with single point connector.

If the vessel sinks, the water pressure will activate the sharp knife which cuts the strong rope that holds the lashing and the liferaft will float free.

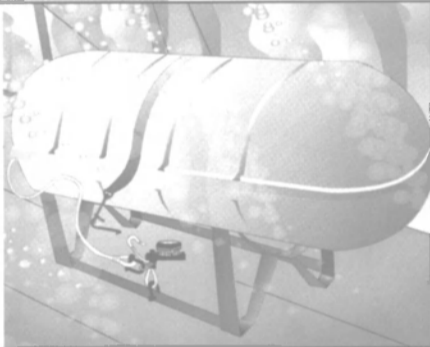

As the vessel sinks, the painterline will be stretched and the liferaft starts to inflate.

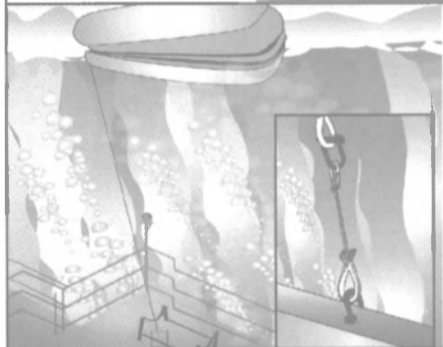

Red weaklink breaks and survivors can board the inflated liferaft.

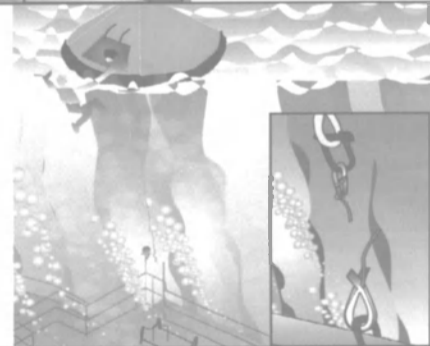

- Revised model with a single point connector for painter line
- Simple to install, safe and has a more effective construction
- It needs no service or maintenance
- Fits all liferafts & EPIRBs of all shapes and sizes
- It's approved by most shipping authorities

## HAMMAR®

KEEPING YOU AFLOAT IS OUR BUSINESS

Phone +46 31 709 65 50, Fax +46 31 49 70 23  
info@cmhammar.com, www.cmhammar.com

Circle 215 on Reader Service Card  
or visit [www.maritimereporterinfo.com](http://www.maritimereporterinfo.com)

## Introducing Dens-Marine™ from Georgia-Pacific. The new wave in bulkhead panels.

Dens Marine Bulkhead Panel from Georgia Pacific is a U.S. Coast Guard approved gypsum bulkhead panel for merchant vessels and platforms. It's a 1/2" glass mat gypsum panel that can be used with conventional metal framing. Other unique features include:

- Less costly than other interior joiner wall panels
- More design flexibility than conventional joiner panels
- Approved to use in B-O, B-15, B-30 construction
- Able to readily accept finishes and adhered laminates

 **DENS-MARINE™**  
BULKHEAD PANEL

[www.gp.com/gypsum](http://www.gp.com/gypsum)  
Technical Hotline 1-800-225-6119, M-F 8-6 (ET)

Circle 322 on Reader Service Card  
or visit [www.maritimereporterinfo.com](http://www.maritimereporterinfo.com)



Capt. Ficher, operations chief at the Brunsbüttel Vessel Traffic Management Station. (photo credit: Alan Haig-Brown)

has a capacity for 4,389-teu with 400-teu reefer capacity. The main engine is a Hyundai MAN B&W 9K90MC-C turning 96-rpm at sea and having an output power of 41,040 kW (55,890 bhp). Its five-blade propeller has a diameter of 8,200 x 7,979 mm mean pitch and can drive it through the ocean at a 24.3-knot service speed.

But its speed was restrained as it moved smoothly up the golden moon path toward Hamburg with quiet exchanges between the pilot, captain and helmsman in the soft glow of the radars. Fifty-four year old Urohn spoke of keeping pirate watch in the Straits of Mallaca even though the fast, high sided container ship is less vulnerable than laden bulkers. And he spoke of being at sea since he was an 18-year-old. With two daughters and grandchildren he has successfully balanced the mariner's life with a 30-year marriage and now, with the children grown, he often has his wife onboard. At Hamburg the ship would take on a new chief engineer and captain who would get a familiarity cruise with Urohn and the present chief staying aboard until the next port.

Just below Hamburg, the river pilot was joined on the bridge by two docking pilots. After handing over the ship he went down to the waiting launch. When docking ships of a certain size and especially when it will be required to turn them 180 degrees in a turning basin, regulations call for two pilots to be on board. This ensures full visibility with one on each bridge wing. The Hyundai Praha would be going into a basin then fitting into a spot between two moored container ships. A tight maneuver in dead water, but with as much as two knots of current, it would require concentration and coordination between the bridge crew and the two docking tugs.

As do most European ports, Hamburg has a large contingent of Z-drive and cycloidal drive tractor tugs and the pilots know how to use them to best effect. With one tug made up mid-ship on the transom and the other working the starboard bow, the ship moved into the basin. To one side a Hapag-Lloyd ship was moored with bunkers barges alongside. On the other side an APL ship was taking on containers. Just astern of the

Hanjin Praha a second container ship waited to enter the basin, while further up in the finger still another ship waited to exit the port. For this tricky but routine maneuver, Capt. **Jan Venghaus** would serve as second pilot with Capt **Kai Supper** taking the lead role. Working with calm assurance they turned the ship and gently guided it to kiss the pier

where lines were made fast. The men's calm manner is marked by the precision of the vessel's placement. After a quick farewell to Capt. **Jens Urohn**, the two men left the ship by companion way and taxi. The port of Hamburg has good growth potential from the opening of Eastern Europe and many well established business like the Blohm-Voss

shipyards. The port's pilot services continue to have a ready supply of seasoned mariners to draw upon, but the German role in world shipping is destined to continue shifting and evolving along the lines suggested by the Hamburg Nautical Institute's conversion to the Hamburg Institute for Ship Handling

## Gas Generation Systems

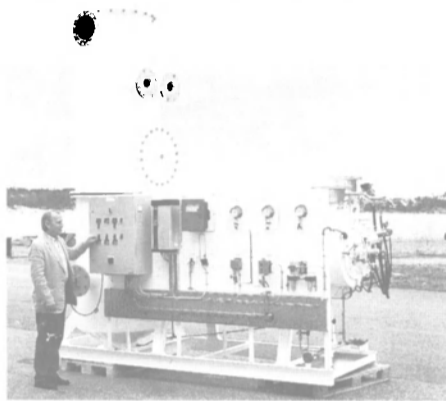

- > 600 Permea Maritime Protection® inert gas systems!
- > 300 Shipboard nitrogen systems!
- > 90 Offshore nitrogen systems!

**AIR PRODUCTS**

### AIR PRODUCTS AS

P.O. Box 8100 Vagsbygd, N-4675, Kristiansand S., NORWAY  
Telephone: +47-380-39900 Telefax: +47-380-11113  
E-mail: airproducts@online.no

Circle 201 on Reader Service Card  
or visit [www.maritimereporterinfo.com](http://www.maritimereporterinfo.com)



For the new Millennium

## Multi Stage Flash (MSF) Evaporators for Cruise Ships

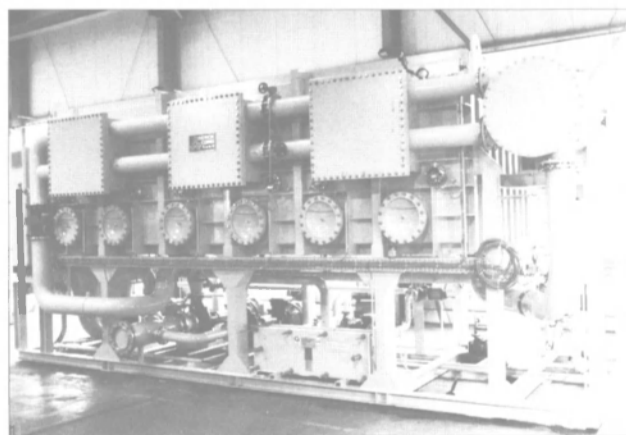

One of two 700 m<sup>3</sup>/d MSF-Units for RCI-Vessel „MILLENNIUM“

(Ship series comprises 4 vessels fitted with 2 x 700 m<sup>3</sup>/d units each.)

Fresh Water treatment according to WHO standards

**SERCK COMO GmbH Germany**  
Pankower Str. 16-18 · Tel.: ++49-4152 / 805-0  
D-21502 Geesthacht · Fax: ++49-4152 / 805 105  
e-mail: Post@Serckcomo.com · Internet: www.serckcomo.com

Circle 290 on Reader Service Card  
or visit [www.maritimereporterinfo.com](http://www.maritimereporterinfo.com)

# THE GAUGER

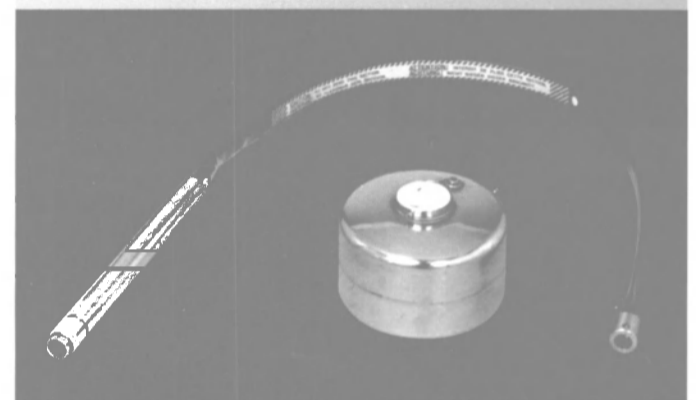

## Have One-Tenth of an Inch Level Accuracy for All Liquid Cargos!

This technology requires no in-tank support. The structure has proven reliability on over 10,000 tanks worldwide and has complete milspec self-diagnostics.

- Made of two materials: teflon and stainless steel.
- Can include multiple temperatures.
- Can include tank header pressures.
- USCG and ABS approved for closed tank gauging.
- FM approved Class I, Div. I, Group C & D.
- Big Blue compatible.
- Readout in BBLs/Tons/GAL, etc.
- Sea-made for leak detection.
- Multiple display options.
- Complete load Management Software.
- Embedded Pump Control capability.

**EMS**

ELECTRONIC MARINE SYSTEMS, INC.  
800 Ferndale Place  
Rahway, NJ 07065

Call today for more information!

732.382.4344  
732.388.5111 fax  
emsmarcon@aol.com e-mail  
<http://www.emsmarcon.com>

Circle 228 on Reader Service Card  
or visit [www.maritimereporterinfo.com](http://www.maritimereporterinfo.com)

# NautiCast Offers AIS Solution

**NAUTICAST**

Vienna, Austria-based NautiCast Schiffsnavigationssysteme specializes in the development and distribution of refined AIS navigation aids, catering for both the commercial and leisure ship-

ping industries as well as ports and VTS centers. The core product of the X-Pack range is the X-Pack DS AIS-Transponder, a product literally designed to anticipate not only today's, but also tomorrow's requirements of an AIS in the maritime industry. The X-Pack DS was developed with NautiCast and is assem-

X-Pack DS AIS from NautiCast

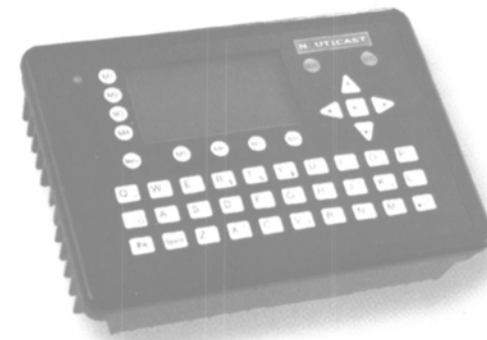

**X-Pack DS —**

**Technical Features include:**

- All functions integrated into a single unit
- Integrated VHF transmitter and receiver
- Integrated GPS receiver
- Integrated power supply
- Integrated alphanumeric display

bled to ISO 9001 Standard by Siemens AG Austria.

The X-Pack DS AIS-Transponder automatically and continuously broadcasts and receives static, dynamic and voyage related ship data and exchanges it with other AIS equipped vessels and shore stations within VHF range.

Not only the technical functionality, but also the straightforward operation and compact design — measuring just 280 x 200 x 60 mm and weighing only 2,500 grams — the NautiCast Transponder was designed with the maritime industry in mind. NautiCast have tailored the trim, all in one unit with integrated alphanumeric keyboard to the limited space available in ships bridges today. The X-Pack DS not only promises to spare precious space once installed, its plug and play design ensures that installation times are kept down to a minimum. The X-Pack DS interfaces with existing NMEA compatible equipment and sensors thereby ensuring problem free retrofitting and also allows connection to PCs, notebooks, radar systems, ECDIS and Voyage Data Recorders.

NautiCast has already gained field experience on Austria's inland waterways. Its portable and riverside AIS-Transponders were chosen to supply the official European Community AIS testing area for River Information Services on the Danube. In the course of this project, NautiCast was called upon to develop a portable AIS-Transponder unit, which is currently given to ships free of charge on loan by the Austrian Supreme Shipping Authority, and remains on board during the ship's journey through the Austrian stretch of the Danube testing area.

Circle 28 on Reader Service Card  
[www.maritimereporterinfo.com](http://www.maritimereporterinfo.com)

## The Blue Ribbon Filters

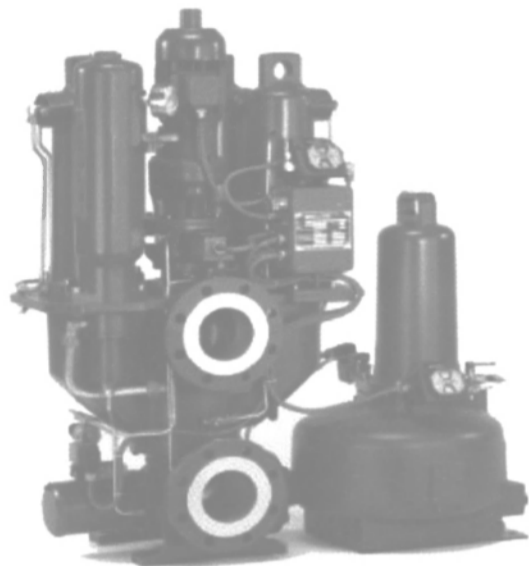

For over 50 years, BOLLFILTERS have improved the efficiency and prolonged the life of ships' vital equipment throughout the world.



**BOLLFILTER**  
**Protection Systems**

Boll Filter Corporation  
[www.bollfilter.com](http://www.bollfilter.com)

East Granby, CT 800-910-2655  
[boll@bollfilterusa.com](mailto:boll@bollfilterusa.com)

Circle 213 on Reader Service Card or visit [www.maritimereporterinfo.com](http://www.maritimereporterinfo.com)

## GLOBAL BUNKER SERVICE

24 Hours Supplying:

- Fuel Oil
- MDO, MGO
- Marine Lubricants

Fixed Price Agreements

Offices Around the Globe

**DENMARK**  
 Phone: +45 98 12 72 77  
 E-mail: [owbunker@owbunker.dk](mailto:owbunker@owbunker.dk)

**SWEDEN**  
 Phone: +46 8 440 46 90  
 E-mail: [owswe@owbunker.se](mailto:owswe@owbunker.se)

**GERMANY**  
 Phone: +49 40 32 55 900  
 E-mail: [hamburg@owbunker.de](mailto:hamburg@owbunker.de)

**NETHERLANDS**  
 Phone: +31 107 891 111  
 E-mail: [owbunker@owbunker.nl](mailto:owbunker@owbunker.nl)

**LATVIA**  
 Phone: +45 98 12 72 77  
 E-mail: [owbunker@owbunker.dk](mailto:owbunker@owbunker.dk)

**ESTONIA**  
 Phone: +45 98 12 72 77  
 E-mail: [owbunker@owbunker.dk](mailto:owbunker@owbunker.dk)

**ICELAND**  
 Phone: +45 70 20 40 49  
 E-mail: [owicebunker@owicebunker.com](mailto:owicebunker@owicebunker.com)



**UK**  
 Phone: +44 1753 48 33 00  
 E-mail: [owbunkersuk@owbunker.com](mailto:owbunkersuk@owbunker.com)

**GREECE**  
 Phone: +30 104 28 4455  
 E-mail: [piraeus@owbunker.gr](mailto:piraeus@owbunker.gr)

**SINGAPORE**  
 Phone: +65 6398 1250  
 E-mail: [owbsin@owbunker.com.sg](mailto:owbsin@owbunker.com.sg)

**SOUTH AFRICA**  
 Phone: +27 21 911 11 23  
 E-mail: [owbunker@mweb.co.za](mailto:owbunker@mweb.co.za)

**O.W. BUNKER**

[www.owbunker.com](http://www.owbunker.com)  
 E-mail: [owbunker@owbunker.com](mailto:owbunker@owbunker.com)



Circle 272 on Reader Service Card or visit [www.maritimereporterinfo.com](http://www.maritimereporterinfo.com)

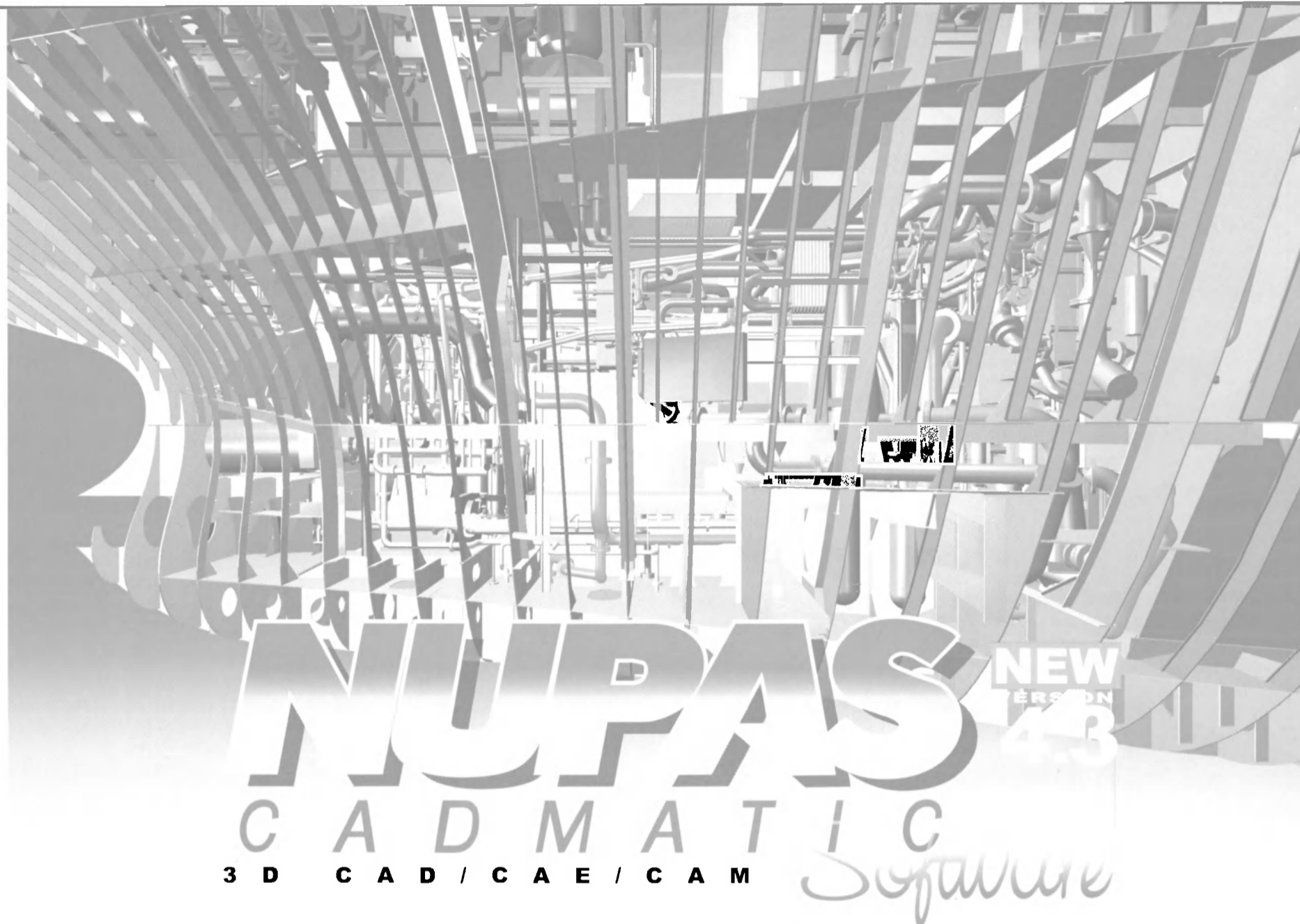

**THE ULTIMATE 3D SHIP DESIGN SOFTWARE TO IMPROVE YOUR SHIP DESIGN AND ENGINEERING**

**N**upas-Cadmatic is a state-of-the-art 3D CAD/CAE/CAM ship design software solution for the designers and shipbuilders. Nupas-Cadmatic enables real concurrent engineering between all engineers for hull, machinery, piping, HVAC and outfitting by using the 3D product model to share the real time information.

With Nupas-Cadmatic you can effectively carry out the whole design project right from the early project design phase up to the production.

You can utilize the powerful and easy-to-use 3D modelling capabilities in basic design, detailed engineering,

produce all needed workshop drawings and finally generate high quality production data.

Nupas-Cadmatic Software runs on both Windows NT and Windows 2000 workstations and servers.



**3D ship design and engineering**

- GA's
- Classification drawings
- Hull structures
- Piping and other diagrams
- Machinery & piping, HVAC
- Accommodation & interior
- Outfitting
- Virtual 3D models
- On-line Walk Arouns
- Windows Video AVI files
- Interfaces with other systems

**Production information**

- Plate and profile cutting
- Plate and profile bending
- Pipe spools and isometrics
- Pipe cutting and bending
- Other material lists
- Centers of gravity
- Weights
- Logistic data
- Data for production robots



CONTACT US FOR MORE INFORMATION



Cadmatic Oy  
Itäinen Rantakatu 72, 20810 Turku, Finland  
Tel +358-2-412 411, fax +358-2-412 4495  
Internet www.cadmatic.com, e-mail sales@cadmatic.com



Numeriek Centrum Groningen B.V.  
Oslweg, 110, 9723 BX Groningen, The Netherlands.  
Tel +31-50-5412 632, fax +31-50-5423 717.  
Internet www.ncg.nl, e-mail sales@ncg.nl

Circle 216 on Reader Service Card or visit [www.maritimereporterinfo.com](http://www.maritimereporterinfo.com)

# Modern Maid-of-All Work



by David Tinsley,  
technical editor

Recent years have witnessed a number of programs involving new series of versatile, omni-purpose ships targeted at the market for project cargoes and otherwise heavy or outsized items of freight. The multiple-vessel nature of the various fleet investment initiatives has meant that a capability for handling more difficult consignments is increasingly allied with a regular, scheduled

service pattern or transportation system, rather than with a purely tramping function. To a degree, this is evocative of the situation years ago when certain cargo liners were equipped with special heavy-lift derricks.

Combining a specialization in project and heavy-lift freight with long experience in liner-type service, Hamburg-based Rickmers-Linie has opened a major new stage of fleet development entailing nine ships of the Superflex Heavy MPC (multipurpose container carrier) designation.

First-of-class Rickmers Hamburg is every inch the modern maid-of-all-work, offering a 640-ton unit lift capacity along with a variable hold space configuration suited to the widest range of breakbulk and conventional cargoes as well as large, indivisible items of freight. The 30,000-dwt Superflex series is due to extend to nine ships before the end of next year, with construction having been distributed among three yards in China.

Testament to the Chinese shipbuilding industry's global competitiveness in an ever-widening range of tonnage, and to its strong links with the German shipowning community, the Rickmers-Linie program entails five vessels from Xiamen Shipyard and two from Jinling Shipyard,

plus the Rickmers Hamburg and a sistership from Shanghai Shipyard.

The five-hold design is fitted with four, high-stooled deck cranes, two of which have a 320-ton maximum lift capacity, while one is rated at 100-tons and other at 45-tons. By using the two largest units in tandem, piece weights up to 640-tons can be handled.

The hatchway layout provides openings up to 105 ft. (32 m) in length and 34 ft. (10.3 m), accessing holds fitted with adjustable tweendecks. The below-deck arrangements mean that the hold spaces can be highly compartmentalized using three flexible tweendecks, or can be configured to give various hold heights up to 15.7-m in accordance with cargo needs, making for optimum space utilization.

Integral dehumidifiers are intended to better ensure the delivered condition of handling-sensitive cargoes such as steel and paper, while the box-like nature of the holds contributes to efficient stow intake and outturn and to a full-load capability for 1,888-teu containers. The service speed of 19.5-knots is indicative of the liner role foreseen for the versatile new breed of general-purpose trader.

"In 2003, when more of the new ships are available to Rickmers, the Round-the-World service will be upgraded for faster transit times and greater regularity," commented the line's marketing manager **Andreas Elger**.

"This transformation — which will see the re-launch of the Round-the-World service as the Pearl String service — will offer shippers unparalleled possibilities for moving project cargo," he added.

Previously untapped market sectors, such as the paper industry, will also be targeted with the employment of the MPC fleet.

The Pearl String service will also include Rickmers' own supporting feeder services, including Asian routings via Shanghai as the hub port.

## Green GL Passports For Boxship Trio

Marking a departure from the company's highly effective chartering strategy of the past 30 years, three self-owned newbuilds are being phased into Contship Containerlines' core Australasian trades during the 2002 second-half.

The 4,115-teu Contship Aurora class is technically distinguished by its considerable scope for perishable cargo, in that 1,300 plugs have been incorporated for integral type refrigerated containers. The trio ordered from Daewoo Shipbuilding & Marine Engineering is replacing tonnage deployed on Contship's Eagle service between Europe, Australia and New Zealand, operated in partnership with P&O Nedlloyd's eastabout and Mediterranean strings, and will ultimately contribute to a new, weekly eastabout, round-the-world schedule.

The dimensioning and engineering of the design for up to 1,300 reefer units equates to a potential, temperature-controlled cargo volume of around 2-million cu. ft., one of the biggest concentrations of reefer transport capacity at sea today. Underscoring Contship's long-term commitment to the business, the investment in the Contship Aurora, Contship Australis and Contship Borealis has been shaped not only by considerations of through-life economic performance and asset value, but also with due regard to rising expectations as to environmental protection. A circumspect approach to the ecological properties of the design is reflected in each ship's construction to the parameters set by Germanischer Lloyd for its new Environmental Passport classification category.

The 'Green Passport' documents the environmental credentials of the ship through a certified compilation of all characteristics relevant to various national and international standards along with the basic requirements laid out in the society's Environmental Service System (GL-ESS) guidelines. The information is put together in such a way as to facilitate use by authorities and agencies for specific purposes such as processing applications for environmentally-governed fee reductions, or running checks on a vessel's environmental status.

There are compelling economic and competitive reasons for shipowners to meet or anticipate the most demanding environmental criteria through voluntary measures, such as the adoption of innovative ecological technologies on board. In addition, more and more shippers and industrial producers have an environmental agenda, which filters down to heightened expectations of environmental performance on the part of the transport service providers.

Against this backcloth, GL has developed its Environmental Service System. While this presently consists of the Environmental Passport, the intention is to extend the concept by introducing an Environmental Passport Information System (GL-EPIS).



# GE Gas Turbines

*Success at Sea...*

*Proven Power for  
Your LNG Carriers*



**W**orldwide GE Gas Turbines are replacing steam turbines and diesel power on military vessels, cruise ships and high-speed ferries. Over 400 such ships now enjoy the efficient, reliable, clean power that GE Gas Turbines deliver.

GE Gas Turbines are ideal in a variety of marine applications including electric prime power, combined cycle boost power, and combined gas turbine diesel electric...making them the perfect solution for the LNG carrier market.

World-proven GE Gas Turbines have dual-fuel capability and can operate on boil-off gas with supplemental liquid fuel as needed. With low SO<sub>x</sub>, NO<sub>x</sub> and particulate emissions, GE Gas Turbines allow LNG carriers access to environmentally sensitive ports.

GE Gas Turbines are the most experienced gas turbines in the world. Gas turbine compressor drive and generator sets operate on offshore platforms and gas pipelines where maintenance free/high reliability are crucial; just like on an LNG carrier.

To put GE Gas Turbines to work for you, contact GE Aero Energy Products at 713-803-0900 or visit [www.gepower.com](http://www.gepower.com)

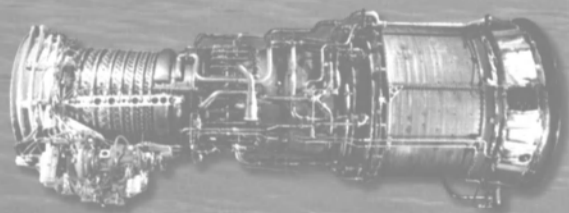

**GE Aero Energy Products**

From ship to shore, C-MAP's professional electronic chart database is there to help you navigate.



- Worldwide coverage on ONE CD.
- Over 18,000 charts available.
- International sales and support.
- Choose from systems by Raytheon, STN Atlas, Sperry Marine, Kelvin Hughes and others.
- Online updating with *Notice To Mariner* corrections.
- Worldwide Tidal Reference Stations included.



C-MAP/Commercial • 133 Falmouth Road • Mashpee, MA 02649 • 508.477.7537 • www.c-map.no

Circle 336 on Reader Service Card or visit [www.maritimereporterinfo.com](http://www.maritimereporterinfo.com)

INTRODUCING SAAB TANKRADAR® STaR:

Well, it looks like another 25 years in the lead.



Take a closer look inside our new tank gauging system, Saab TankRadar® STaR. It will bring intelligence and integration to your tank monitoring—offering a superior range of functions.

The new STaR system features a 3-in-1 solution that integrates Level Gauging, High Level and Overfill Alarm systems in a single unit—designed as independent, intrinsically safe, measuring channels. As a result, it's easy to install, maintain and operate.

STaR takes advantage of a new sensor technology for safer and more reliable loading and discharge. And it's future-proof—the integration capabilities of STaR ensure compatibility with new and emerging software.

STaR is the latest proof of our technology leadership. No wonder that nearly 60% of all the new tank gauging installations in the marine market are designed and delivered by us.



Phone: +46 31 3370 000 • E-mail: [sales.marine@marine.saab.se](mailto:sales.marine@marine.saab.se)  
Web: [www.saabrosemount.com](http://www.saabrosemount.com)

SHAPING THE FUTURE IN TANK GAUGING

Circle 284 on Reader Service Card or visit [www.maritimereporterinfo.com](http://www.maritimereporterinfo.com)

# A German Ferry for All Harbors

The Hanseatic Port of Hamburg on Germany's Elbe River has never shied from innovative means of moving citizens and visiting ship's crew from the south shore harbor area to the beautiful city spread along the river's north shore. In 1911 they built, and continue to use, a tunnel that requires that cars be lowered one at a time in elevators to the sub river level, then drive through the tunnel to be elevated to road level on the other side. The elevator buildings reflect the design sensibilities of the picturesque Northern European port at the same time as displaying the ports continuing trade driven affluence.



Two of the twin Z-drive HADAG ferries pass on the busy Hamburg waterfront.

On the water, sightseeing tourists and commuting workers are moved by a flotilla of ferries representing everything from fine lined vessels with passenger seating in the hulls and a pleasing low profile flowing down a gentle sheer line to a fine fantail stern. These old favorites could never be adapted to today's fast paced bustle and the modern need for serious people movers. That is left to an innovative new series of boats operated by HADAG Seetouristik und Fahrdienst AG.

These 98 x 26-ft. (30 x 8-m) boats have capacity for 250 passengers with stowage space for up to 50 bicycles, handicapped accessible hydraulically operated loading ramps as well as enclosed and open seating. What makes all of this so remarkable is that the vessels are operated safely by only one person.

The success of the vessels cannot be credited to any one feature. It is in the total vessel, starting with the identified needs and concept from the experienced people at HADAG and the resulting design from Netherlands naval architect Fred Van DenBerg. The operator works

from a large enclosed bridge mounted on an arch right aft on the vessel and well above the open second deck. Passengers board aft on the ramps that are

controlled from and can be seen through windows in the floor of the wheelhouse.

The wheelhouse also has 100 percent visibility of the open upper deck and

closed circuit television observation of the enclosed main deck.

The engine room can also be monitored by closed circuit TV. The superstructure is all aluminum to reduce weight, displacement and wake. Sound has been kept to 65 decibels or less in passenger areas.

The beamy steel hull has a shallow 5-

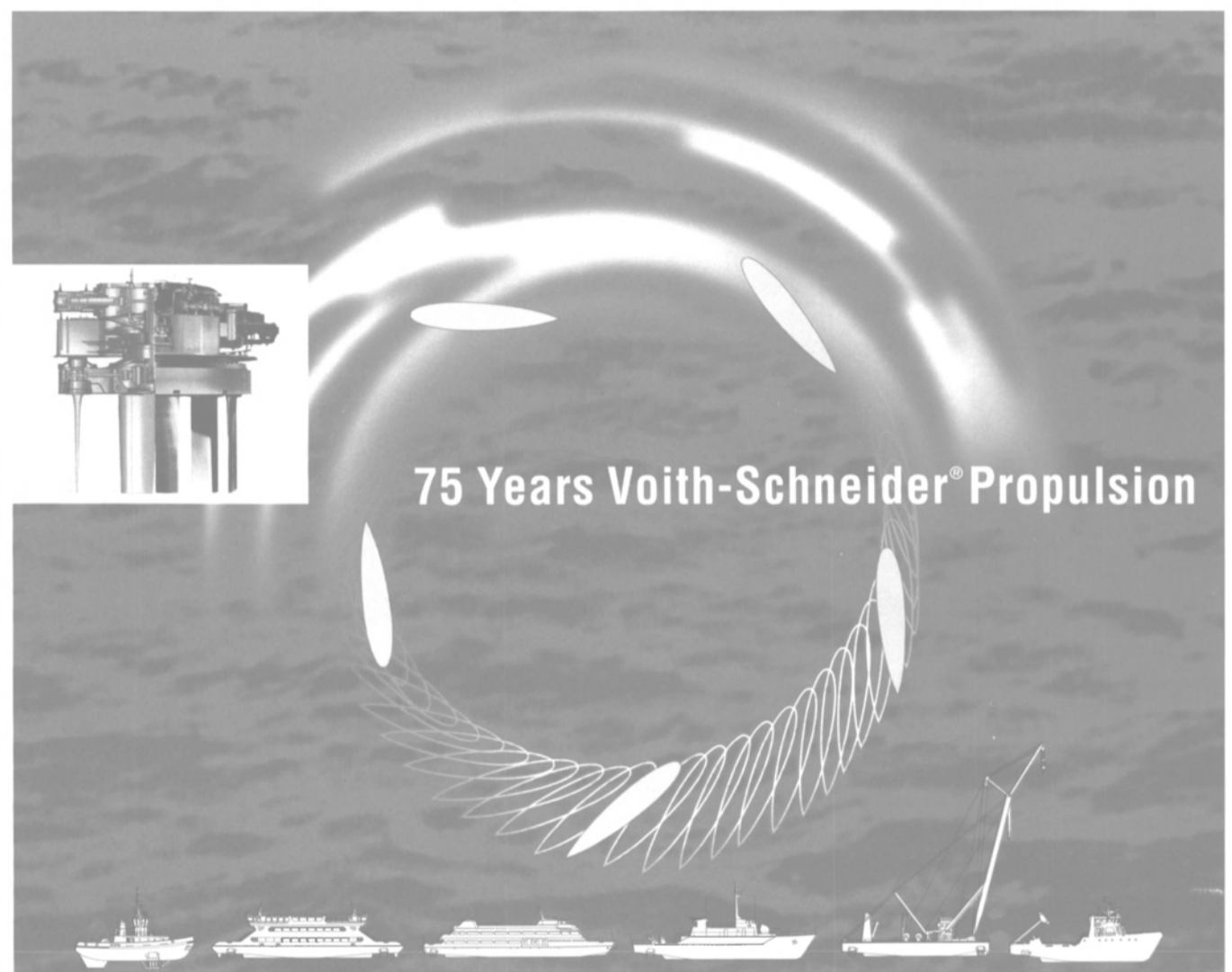

## Reliability – Propelled by Experience



75 years ago Ernst Schneider aroused the enthusiasm of Voith's engineers with a ground-breaking idea for a new type of ship's propeller, using a blade wheel that could vary its settings according to the desired thrust and direction.

The first Voith-Schneider Propeller (VSP) – combining the functions of drive and rudder – appeared in 1927, and was the most innovative drive system in a series of pioneering inventions that have made waterborne traffic significantly safer.

In 1952 a new tug concept revolutionised the manoeuvring of vessels: with two VSPs at the bow and the towing point located behind the tug's axis of rotation, a balanced, stable distribution of forces was achieved – a new dimension in safety. Almost 800 Voith Water Tractors worldwide are today a hallmark for safety, reliability and precision.



**Voith Schiffstechnik GmbH & Co. KG**  
P.O. Box 2011, 89510 Heidenheim, Germany  
Tel. +49 (0)7321-37-6595; Fax +49 (0)7321-37-7105  
vspmarine@voith.com, www.voith-marinetechonology.com

# VOITH

Circle 309 on Reader Service Card or visit [www.maritimereporterinfo.com](http://www.maritimereporterinfo.com)

## SMM • Germany Report

ft. (1.5 m) draft and it is here that the most essential component of the ferry's success is found. A pair of open wheeled Rolls Royce/Aquamaster US381 CRP azimuthing drives are mounted in a finely faired hull. The hulls rounded chine and enhanced design reduces wake while assuring powerful water flows throughout the Z-drives' 360-degree

rotation. Power to the drives comes from a pair of six-cylinder, 14-liter Cummins N14 engines. These electronically controlled engines give the fast response and power required by the operator in maneuvering around the busy harbor traffic. An 75 kW Aquamaster bow thruster further enhances dockside maneuverability while negating the need

for mooring lines and line handlers.

The Cummins, like all other components on the boat, were chosen only after careful comparison and negotiation. They won the prestigious place due to their ability to cope with the heavy load conditions and strong service support from the local Cummins dealer Otto Blank in Hamburg. The first of the 98-ft.



Cummins engine representative, **Lutz Pauleburg**, with one of the Cummins N14 engines that power the HADAG ferries.

## WALZ & KRENZER SLIDING ELECTRO-HYDRAULIC WATERTIGHT DOORS - EXPERIENCE AND A NAME YOU'VE TRUSTED FOR OVER 50 YEARS.

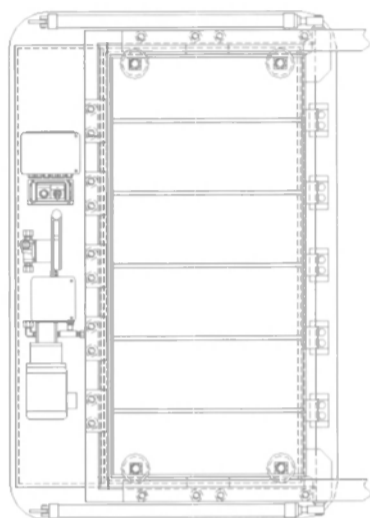

Walz & Krenzer Inc. has supplied more sliding watertight doors in North America than any other single company.

Whether your requirements call for doors which comply with ASTM F-1196/1197 or the new alternate compliance program (SOLAS), go with the company that's been with you from the start.

All WK drawings are approved by on-staff P.E.'s and doors are fabricated in the USA.

### WALZ & KRENZER, INC.

Phone: 203-267-5712 Fax: 203-267-5716

Email: sales@wk-mapeco.com



Circle 259 on Reader Service Card or visit [www.maritimereporterinfo.com](http://www.maritimereporterinfo.com)

(30-m) boats was delivered in 1997 and now has 17,000 trouble free hours on the Cummins engines. The last of this class boat was delivered in January 2002 and, as of late March, had 2000 hours on the mains.

Electrical needs are met by a pair of Cummins 6BT-powered 75 kW generators.

The ferry system in Hamburg handled only two million people in 1996. This has now increased to four million in 2001 with 2.5 million of those carried on a single route that has four boats leaving at 15 minute intervals on its one-hour round trips — that operate from 5:15 a.m. to 11:45 p.m.

The success of the 98-ft. (30-m) boats led to plans for a 82 x 20-ft. (25 x 6-m) vessel with 114-passenger capacity to serve some of the smaller canals in and around the city. These boats will have a 9-ft. (3-m) air draft, compared to the larger boats' 28 ft. (8.5 m), in order of pass under more of the bridges of a city that claims more of them than Venice. Each of the new boats, designed by German naval architect Dr. **Christian Masilge** of Berlin, will have only one of the Cummins N14 main engines and RR/Aquamaster drives with a 35 kW bow thruster. Like the last of the 30-metre boats, the drives on the smaller boat have a pair of five and four-bladed contra-rotating open NiAlBr 950 m/m diameter propellers. Two of these vessels will be delivered in May of this year.



Captain **Karl-Heinz Fritsch** at the controls of one of the single-crewed HADAG ferries.

## MetalCraft Marine

Builders of Fine Quality Patrol and Workboats

K-22 PATROL BY METALCRAFT MARINE USA K-23 PATROL BY METALCRAFT MARINE



S O L U T I O N S



DEEP V BARGE BY STANLEY CUSTOM BOATS VENCREW 43 BY MACNALLY CONSTRUCTION INC

### METALCRAFT MARINE GROUP

MACNALLY CONSTRUCTION INC.  
STANLEY CUSTOM BOATS  
METALCRAFT MARINE CANADA & USA

1-800-410-8464, Intl.: 613-542-1810

[www.metalcraftmarine.com](http://www.metalcraftmarine.com)

Some boats available under G.S.A Contract

"With MCM's 10-year Hull Warranty, We Believe There's No Better Boat Built"

PROUD TO BE A SUPPLIER TO AMERICA'S HOMELAND SECURITY PLAN™

Circle 346 on Reader Service Card  
or visit [www.maritimereporterinfo.com](http://www.maritimereporterinfo.com)

## Cable Transit Problems...



### Rapid Transit® Sealing System

- ✓ Approved: Firestop/Watertight/Gas-tight
- ✓ Approved: ABS, DNV, Lloyds, USCG
- ✓ Saves labor, weight & space vs. block systems
- ✓ RISE Software makes material calculation easy
- ✓ Also approved for single and multi pipes
- ✓ **New RISE Extend-A-Frame - Doubles** usable space in any block system frame!

For a full catalog, software and informational video contact:

**CSD Sealing Systems-North America**  
Tel. 603-641-3914 E-mail: [sales@csdsealingsystems.com](mailto:sales@csdsealingsystems.com)  
[www.csdsealingsystems.com](http://www.csdsealingsystems.com)

Circle 339 on Reader Service Card  
or visit [www.maritimereporterinfo.com](http://www.maritimereporterinfo.com)





Curaçao Drydock Co., Inc.



## Docking possibilities for the New Generation **Cruise Ships**

### **Antillia Graving Dock**

#### **Dimensions:**

Between dockwalls: 280 x 48.00 meters  
Between fenders: 280 x 47.35 meters

#### **Depth of water over the keelblocks:**

**At the entrance:** 8.00 meters with a slope of 1:200

Keelblock arrangement specially designed and adapted to dry-dock Large Cruise Vessels with a trim of 1:200 (angle of heel  $\text{tg.}\alpha = 0.005$ )

Efficient modern hauling system with semi-automatic winches and trolleys moving along rails at both sides of the dry-dock, allowing complete control during the repairs.



Curaçao Drydock Co., Inc.

Curacao Drydock Company, Inc.  
Dokweg 1, Koningsplein  
P.O.Box 3012  
Curacao, Netherlands Antilles  
Phone: (599)9-733-0000  
Fax: (599)9-737-9950

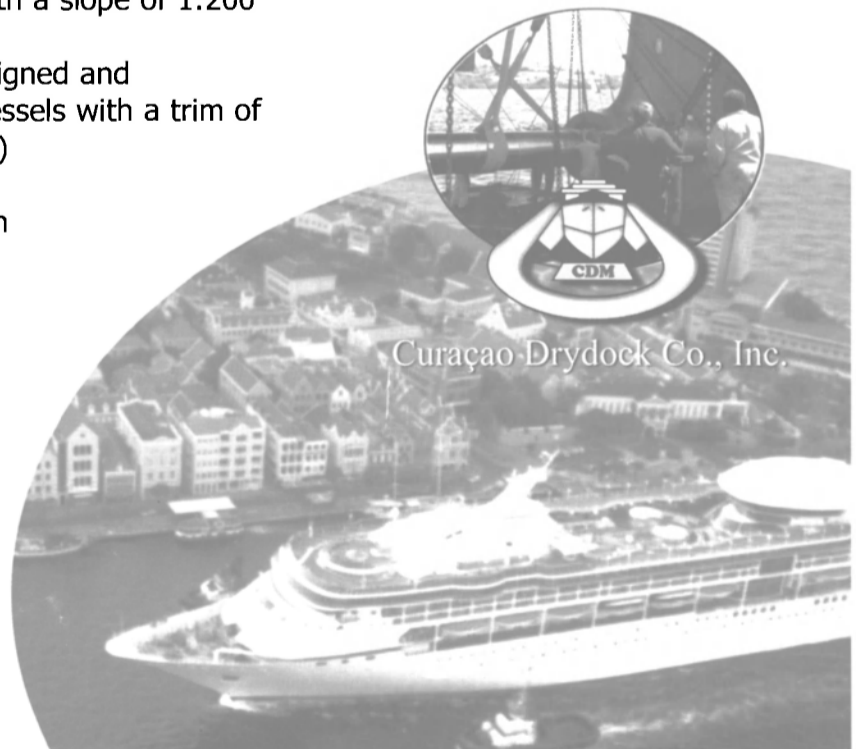

**Jets Vacuum To Introduce New Retrofit Solution For Vacuum Toilet Systems**

New retrofit solution for Vacuum toilet systems Jets Vacuum AS has introduced an efficient and easy-to-install solution for the upgrading of old Vacuum generating units on passenger ships. This allows for a boost in Vacuum generating capacity as well as eliminating the use of anti-foaming agents normally needed with second generation Vacuum units. In addition to the capacity increase, the Jets solution will also improve the biological treatment process. The equipment is very compact and the in-line installation allows for an extremely easy connection to existing pipework.

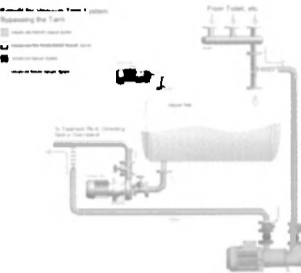

Circle 149 on Reader Service Card  
www.maritimereporter.com

**Jotron to Launch New Products at SMM 2002**

At SMM 2002 in Hamburg, the Norwegian-based Jotron Group will introduce a number of new products, including a new UHF Radio and AIS system. Tron UHF, portable maritime UHF transceiver, is based on the same design as the highly successful Tron TR20 VHF personal portable radio for marine emergency and onboard communication. Tron UHF is fully waterproof with an illuminated keyboard and backlit graphical display to facilitate ease of use. Awaiting the final international approval, Tron UHF complies to international standards ETS 300086 and ETS 300720. The Tron UHF features CTCSS and CCIR five-tone sideband signalling, Dual/Triple watch function, Channel scanning and is fitted with an accessory socket for external headset/microphone. Powered by re-chargeable NiMH batteries, the radio comes with a bulkhead or a table mountable dual slot rapid charger, also able to operate on trickle mode.



Circle 150 on Reader Service Card  
www.maritimereporter.com

**Oilmate**

Are you looking to improve your profitability? Oil Mate can help by eliminating the downtime and money spent on diesel engine maintenance. Engineered Machined Products, Inc. is proud to introduce its newest aftermarket product, Oil Mate, previously sold exclusively to diesel engine manufacturers. The Oil Mate significantly extends oil change intervals (2,000 hours) and filter life in order to decrease downtime and lengthen your engine's life span. This oil management system removes a small amount of used engine oil and blends it with diesel fuel to be burned during combustion. The used oil is then replaced with an equal amount of fresh oil from a make-up tank, extending oil and filter use. This system outperforms every competitor on the market. It is currently used and certified by a major diesel engine manufacturer, operates within emissions guidelines, and is guaranteed for one full year.



Circle 151 on Reader Service Card  
www.maritimereporter.com

**Schottel to Exhibit New SEP at SMM 2002**

Schottel's new product, an Electric Propulsor (SEP), will be the focus at the company's stand at the SMM 2002 exhibition in Hamburg (Stand no. 12021). The development of the SEP is the result of investigations into the market demand for pods in the smaller power range. This innovative pod drive system covers the power range of one to five MW. Schottel offers podded drives with different kinds of electric motors: asynchronous, synchronous and permanent-magnet motors depending on the owner/shipyard request and application of the vessel. Pod drives in twin propeller version are particularly suitable for the market sectors RoPax, double-ended ferries, supply vessels, tankers, container ships and yachts. For the offshore industry, pods with single propellers in nozzles are part of the new development. The Schottel Electric Propulsor provides a supplement to the company's existing product range of both azimuthing and conventional propulsion and maneuvering systems.



Circle 152 on Reader Service Card  
www.maritimereporter.com

**STN to Showcase Atlas Marine Electronics at SMM**

STN ATLAS Marine Electronics will exhibit a comprehensive range of advanced ship automation, communication, navigation and power management systems under the theme, Always a Step Ahead. Key exhibits include a proprietary Ship Control Centre (SCC) integrating and automating all main bridge equipment operating functions for navigation, communications and general ship management. It incorporates a latest NACOS Series 4 navigation command system inclusive of Chart radar Atlas 1000, a new type-approved unit combining radar, electronic charting and conning functions. Chart radar Atlas 1000's innovative functions will also be featured separately together with other nav aids including the Debeg 3400 UAIS transponder with interfaces to Radarpilot 1000, Chartpilot and a new 3401 DCU minimum keyboard display for retrofitting with the UAIS. **Hall 12, Stand No. 12024**



Circle 153 on Reader Service Card  
www.maritimereporter.com

**SMIT and Frank Mohn Complete Operations**

In cooperation with its Norwegian partner, the pump specialist Frank Mohn, SMIT has completed a number of highly successful operations involving the recovery of oil and chemicals from vessels located on the seabed at greater depths. In the salvage industry, 'greater depths' refers to operations in water deeper than 164 ft. In the past, work at this depth required a technique called saturation diving and the utilization of expensive diving support vessels. In searching for a more economical solution to the recovery of oil and chemicals from 'greater depths', SMIT and Frank Mohn developed the PolRec (Pollution Recovery) System. Since its development, this system has proven itself with the successful recovery of oil from two tankers, Yu-II 1 and O-Sung 3, both of which had sunk to a depth of 262 ft. off the Korean coast. The completion of this operation earned SMIT and Frank Mohn the internationally acclaimed Seatrade Award in the Countering Marine Pollution category.



Circle 154 on Reader Service Card  
www.maritimereporter.com

**Caterpillar Motoren Presents V-type M43 at SMM Hall 6, Stand 6011**

Caterpillar Motoren GmbH & Co. KG, of Kiel, Germany, introduced four new heavy-fuel engine series to the marine market between 1992 and 2000 and presented them at the respective SMMs. At this year's SMM the company is presenting yet another new engine — the V-type M 43. The VM 43 will be available in 12, 16 and 18 cylinder versions. It doubles the maximum available output of the existing Caterpillar Motoren Engine Program, so that it now covers a range from 1,020 kW/1,380 HP to 16,200 kW/22,030 HP. This latest product is opening up important new market segments. As with all MaK engines of the new long-stroke generation, the design of the VM 43 was kept as simple as possible, which is an advantage to yards and operators in terms of ease of installation and low operating costs, due to minimum down times for service and to very easy maintenance. Its design is based on the successful in-line version, the M 43. Because the engine has the same speed, stroke and bore, it has been possible to make use of a large number of components of the M 43, e.g. cylinder head, connecting rod, piston, cylinder liner with calibration ring, valve drive, cooling water ring and the turbocharger. All these are identical in the in-line and V-versions. Caterpillar Motoren has built on extensive operational experience with these M 43 components and their impressive proof of reliability and economy, as well as their user-friendliness in operation and maintenance. An important new design characteristic is the "Flexible Camshaft Technology", the result of a development step taken to reduce NOx emissions and soot emissions to below the IMO limit over the entire operating range. The VM 43 is the first Caterpillar Motoren product to feature this technology which is internal to the engine. The M 43 in-line engine was introduced to the market in 1998 very successfully. Up to now, more than 180 engines with a total output of about 1,300 MW have been sold. It is the market leader in its output class. The VM 43 has also made a good start — the first six engines of this type have been sold already.

Circle 155 on Reader Service Card  
www.maritimereporter.com

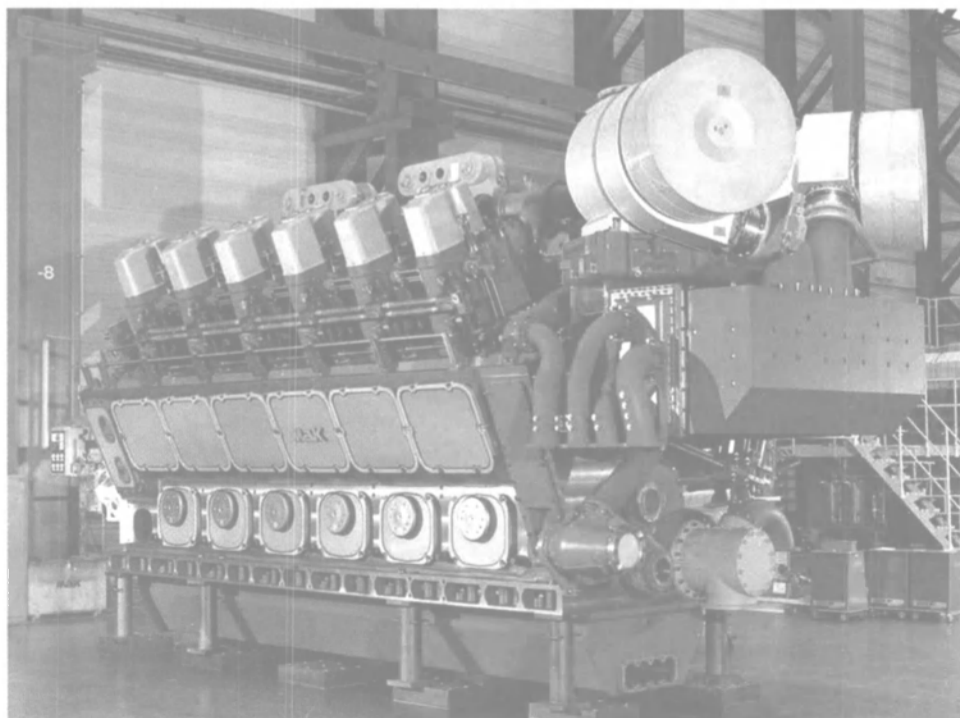

### Oilsafe

Prevent equipment-damaging lube contamination and costly oil spills with Oil Safe Lubrication Tools. Whether you need to transport your oil 20 ft. or 20 miles, the unique Oil Safe sealing system will keep your lubricants safe from contamination and spills.



Oil Safe Lids are available in eight colors, allowing you to color code lubricants, thus minimizing the risk of topping off your machinery with the wrong oil. The surest way to keep your equipment up and running is through proper lubrication using clean lubricants.

Circle 199 on Reader Service Card  
[www.maritimereporter.com](http://www.maritimereporter.com)

### Mi-Jack Products

The Mantsinen 60 makes material handling more efficient than ever. Its width and stability makes it possible to handle pulp, scrap, paper, timber and lumber- almost efficiently



and safely.

The Mantsinen 60 offers an extensive range of lifting accessories making it possible to lift almost any type of material. Grabs, roller pinners, forks, lifting hooks, clamshells and different spreaders for any application.

Circle 198 on Reader Service Card  
[www.maritimereporter.com](http://www.maritimereporter.com)

### L-3 Communications

L-3 Communications is a merchant supplier of defense electronics and a growing provider of commercial communications and transportation products. The company supplies high technology, proprietary products to the Department of Defense, prime contractors, international customers, OEMs and to the space and telecommunications markets.



Circle 197 on Reader Service Card  
[www.maritimereporter.com](http://www.maritimereporter.com)

# X-Pack DS™

## The Multifunctional AIS Transponder

Manufactured by Siemens - according to ISO 9001 and IMO Standard

XL in functions  
XS in dimensions  
expect more

Visit us at SMM, Hamburg  
Hall 7, Stand 7010

more safety  
more usability  
more information

NautiCast AG  
Mariahilfer Strasse 50/2/11, A-1070 Vienna, Austria, Europe  
Tel.: +43/1/5 237 237-0, Fax: +43/1/5 237 237-150  
e-mail: [info@nauticast.com](mailto:info@nauticast.com) [www.nauticast.com](http://www.nauticast.com)

Especially designed for: Commercial Shipping Leisure Boats Ports/VTS Authorities

Circle 337 on Reader Service Card or visit [www.maritimereporterinfo.com](http://www.maritimereporterinfo.com)

## Capsat® Fleet77 - Already More than 200 Systems Installed

Fleet

The Next Generation  
Capsat® Fleet77 is based on the new Inmarsat Fleet F77 service and is the next generation of maritime satellite communication terminals.

Great Experiences with Already Installed Capsat® Fleet77 Systems  
More than 200 Capsat® Fleet77 systems have been installed with great success. The installations count a wide range of vessels within merchant, fishery, and the navy as well as super yachts.

[www.tt.dk/fleet](http://www.tt.dk/fleet)

Worldwide Network of Service  
Capsat® Fleet77 is covered by Thrane & Thrane's Capsat® Fleet Service Partner Network. This means that a worldwide network of engineers always will be ready to provide the service you need quickly and efficiently.

Thrane & Thrane A/S  
Denmark  
[www.tt.dk](http://www.tt.dk)  
[info@tt.dk](mailto:info@tt.dk)  
+45 39 55 88 00

## Thrane & Thrane

We bring satellite communication down to earth

Circle 306 on Reader Service Card or visit [www.maritimereporterinfo.com](http://www.maritimereporterinfo.com)

## SMM • Germany Report

### Rutter Technologies: VDR Manufacturer Exhibits Again at SMM 2002

Once again, Rutter Technologies will be exhibiting at this year's SMM show in Germany. In addition to showing the Rutter VDR-100 with its multiple options and advanced features, Rutter Technologies will also be introducing a new line of interface modules. The interface modules demonstrate the company's in-depth understanding of the real issues accompanying VDR installations and confirm their status as a market leader and innovator. Rutter Technologies... leading the marine industry in VDR technology.



Circle 156 on Reader Service Card  
www.maritimereporter.com

### Resurgence Software

Resurgence Software Inc. produces the Wave Software System, an equipment reliability analysis software system that enables ship owners and operators to achieve the best operating and financial performance of their fleet possible by maximizing vessel uptime and minimizing maintenance costs and the risks of failure. Instead of relying on inadequate information and ad hoc decision-making, the Wave Software System provides owners and operators with the critical reliability information needed to make better maintenance, repair, replacement and capital expenditure procurement decisions.



Circle 157 on Reader Service Card  
www.maritimereporter.com

### Willi Becker Ingenieurburo Becomes Becker Marine

The German limited company Willi Becker Ingenieurburo changed its name to Becker Marine Systems to reflect its shift towards an increasingly global position as a system provider for rudders and steering gear, which development had been going for some years. While the name of the company has been changed, the substance of the company will remain the same. The new name will involve the addition of new operating areas to those already in existence. The new managing director Dirk Lehmann will concentrate the company's efforts in particular on the expansion of the new areas of operation. The new advances are expected to become most noticeable through a wider range of products, comprehensive technical support and even higher product quality. Already this year the product portfolio, traditionally consisting of rudders, Kort nozzles and steering gears has been amplified and now also includes complete rudders systems.

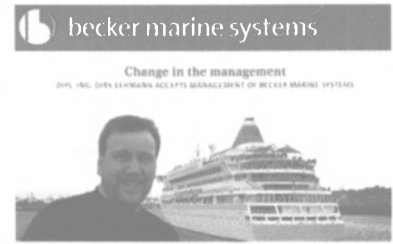

Circle 158 on Reader Service Card  
www.maritimereporter.com

### Beele Engineering Adds Light Switch Highlighter to Range of Yfestos Products

Beele Engineering (Aalten, the Netherlands) has added a luminescent light switch highlighter to its range of Yfestos products. In an emergency, the highlighter prevents time being lost in unnecessary searching for light switches. The highlighter is available in various sizes and operates independently of the power supply. In darkness it emits a clear blue-green light for over 12 hours. The material retains its light absorption and emission properties for over 20 years. The Yfestos evacuation route signposting system includes luminescent footprints, polycarbonate plating for light fittings, shapes, sheeting and strip, tape, paint, discs, fluorescent lamps and compound, as well as alphanumeric symbols and pictograms.



Circle 159 on Reader Service Card  
www.maritimereporter.com

### MWH Presents Entire Range of Products and Services

At this year's SMM 2000 Markisches Werk Halver (MWH) presents its entire range of products and services. Components and services for Medium-Speed 4-Stroke Diesel Engines: Valve Spindles, Valve Seats and Valve Guides. Decades of field experience and the passage of various product lifecycles has resulted in a continuous optimization of components (PRISE — Product Improvement Services). The product range comprises a multitude of valve spindles in various designs, various valve seats with individual cooling methods and optimized valve guides. Valve Rotators, The Turnomat rotation device provides for much longer lifecycles for valve spindles and valve seats. A polishing effect, which is forced by the rotation of the valve spindle, removes combustion deposits between the valve and the valve seat. This effect also improves the temperature distribution around the valve seat in order to minimize so called "blow-bys". Valve Cage/Cylinder Head Units and Reconditioning. MWH reconditions entire valve cage and cylinder head units. Incoming components are submitted to a rule-based inspection (RUBI). Based on the result of this inspection, a detailed reconditioning work package is drawn up.

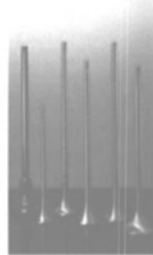

Circle 160 on Reader Service Card  
www.maritimereporter.com

### CompAir to Provide Navy with Compressed Air Technology

CompAir Drucklufttechnik will be represented by a wider range of products than ever before at this year's SMM in Hamburg. A real highlight of the exhibits on show will be the water-cooled compare H5437 high pressure piston compressor. This production series builds on the well-established Reavell concept. The compressor is designed for a pressure range from 140 to 414 bar, with a delivery capacity of between 60 and 170 m<sup>3</sup>/h. The membrane dryer located between the third and fourth stage is absolutely unique. The component is energy-neutral, fully wear-resistant and maintenance-free. The Simmern-based company is using a cutaway version of the H5417 model from its H5000 series to demonstrate the sophisticated action of its compressors. Depending on the model, units from CompAir's H5000 series offer a delivery capacity ranging from 24.8 to 291.5 m<sup>3</sup>/h at an operating overpressure of between 20 and 414 bar.

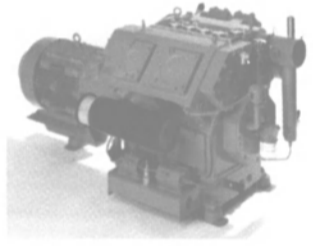

Circle 161 on Reader Service Card  
www.maritimereporter.com

### Alfa Laval Establishes Help Desk

By calling 1-866 ALFA LAVAL (1 866 253-2528), Alfa Laval customers can now receive help with heat exchanger, separator and decanter questions from Alfa Laval's newly established Help Desk. Callers speak directly to a member of the technical support staff who is knowledgeable on all products and relevant applications. The technical support staff is qualified to answer questions regarding troubleshooting, maintenance, operation, performance and process information. Should the staff member be unable to answer the question directly, the customer is guaranteed an answer within 48 hours. The Helpdesk is manned standard business hours (8:00 a.m. to 5:30 p.m. EST) five days a week and backed by an emergency service during our non-business hours. If the issue cannot be resolved on the telephone, the caller is referred to a field service scheduler who will dispatch a service representative. Service is also available from one of Alfa Laval's six service centers, four of which specialize in heat exchangers and three of which service separation equipment.



Circle 162 on Reader Service Card  
www.maritimereporter.com

### Transas to Launch New Nav Products in Germany

Transas will exhibit under the motto "Safety. Quality. IT." at the SMM 2002 show. The Transas stand will present a concentration of the latest IT developments in marine navigation and simulation embodied in high-quality equipment aimed at providing safety at sea and ashore. The highlight of the Transas exposition will be the launch of the new-generation 3000 line of navigational products. The range was started in June 2001, by the Navi-Sailor 3000 navigational system that incorporated all the functionality of the previously type-approved ECDIS with some additional innovative features. Since then, the range of new-generation onboard systems has expanded with the Navi-Radar, PC-based radar display system; the Navi-Bridge; the Navi-Fisher, electronic chart system specifically adapted for fishery vessels. These latest solutions will be introduced at the exhibition, including the recent enhanced version of Navi-Sailor 3000 ver.2 with UAIS transponder interface. To illustrate the advanced capabilities of the UAIS manufactured by Transas - McMurdo, a live demonstration of the equipment will be performed on the stand.



Circle 163 on Reader Service Card  
www.maritimereporter.com

### ILS-Software Package for German Coast Guard

Just two weeks after christening the first of three 216-ft. (66-m) Offshore Patrol Vessels, the German Coast Guard (Bundesgrenzschutz) ordered an extensive software and data package for Integrated Logistic Support (ILS) of the new "Bad Bramstedt"-class from Abeking & Rasmussen, designers and builders of the new vessels. The order consists of three on-board versions and one shore version of the new developed Virtual Ship Explorer (VSE). The logistic company Ocean Logistics GmbH, a subsidiary of Abeking & Rasmussen is responsible for the total system. With the on-board version the crew will be able to manage all documentation for on-board systems, including full spare parts logistic, i.e. from choosing relevant parts from the respective spare parts lists, to storage up to ordering parts needed. The system includes compilation of all relevant technical logs as required by law and assists all requirements of the ISM Code.

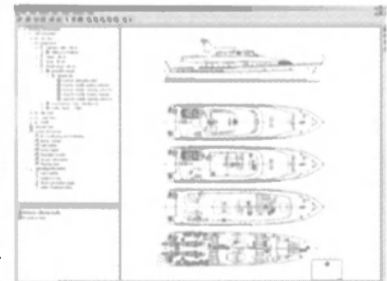

Circle 164 on Reader Service Card  
www.maritimereporter.com

## Germanischer Lloyd Classifies New Tankers

Classed by Germanischer Lloyd, the 31,600 dwt Seychelles Pride is a new addition to GL's stable of technological-ly sophisticated double-hull product tankers. Designed for the transport of chemicals (IMO Type 3), oil, and oil products, it represents a further development of the "Lindenau Safety Tanker Class 2004," which has received a number of international awards for innovative design and safety.



Delivered in June 2002, it is the fifth vessel in this successful series to be classed by GL. Built for Seychelles Shipping Lines Ltd. by the Lindenau shipyard at Kiel; the new tanker will be operated by Columbia Shipmanagement Ltd. of Limassol.

Seychelles Pride was joined by a sixth tanker in the series — the 34,200 dwt "Eberhardt Arctic," which was launched on July 20, 2002 for the Carl F. Peters shipping company of Bargteheide, Germany. The vessel was also built by the Lindenau yard at Kiel.

Circle 37 on Reader Service Card  
[www.maritimereporterinfo.com](http://www.maritimereporterinfo.com)

## JWP-26-C Generator Offers Low Scaling

The JWP-26-C Plate Type Freshwater Generator with titanium plates offers low scaling rates with high levels of performance and reliability. With its compact, lightweight design, the JWP-26-C is ideal for newbuildings or as a replacement unit on an existing vessel.

Supplying high quality fresh water for all domestic and process needs onboard ships, the JWP-26-C Plate Type Freshwater Generator converts seawater into fresh water by vacuum distillation, utilizing waste heat from engine cooling water systems or other sources.

Maintenance requirements are low. Titanium plates in the heat exchangers and extensive use of non-ferrous materials prevent corrosion of vital parts.

The low scaling rate also reduces maintenance requirements. If cleaning becomes necessary, the front cover accessibility of the JWP-26-C makes the task simple.

Circle 66 on Reader Service Card  
[www.maritimereporterinfo.com](http://www.maritimereporterinfo.com)

September, 2002

**JOTRON**  
your safety - our concern

**Tron SART**  
GMDSS 9Ghz  
Radar  
Transponder  
Int. appr.

**Tron TR20 GMDSS**  
Handportable  
GMDSS VHF Radio  
Int. appr.

**TR-710**  
VHF AM desktop  
transceiver

**Tron 40S/40GPS**  
GMDSS 121.5/  
406Mhz EPIRB  
Also available  
with Integrated  
12 Channel GPS.  
Int. appr.

More than 200 approved agents throughout the world. World wide sales and service

JOTRON Electronics a.s  
P.O. Box 54, NO-3280 Tjodalyng, Norway  
Tel: +47 33 13 97 00 Fax: +47 33 12 67 80  
salesmar@jotron.com  
www.jotron.com

Circle 249 on Reader Service Card or visit [www.maritimereporterinfo.com](http://www.maritimereporterinfo.com)

any time. any place.

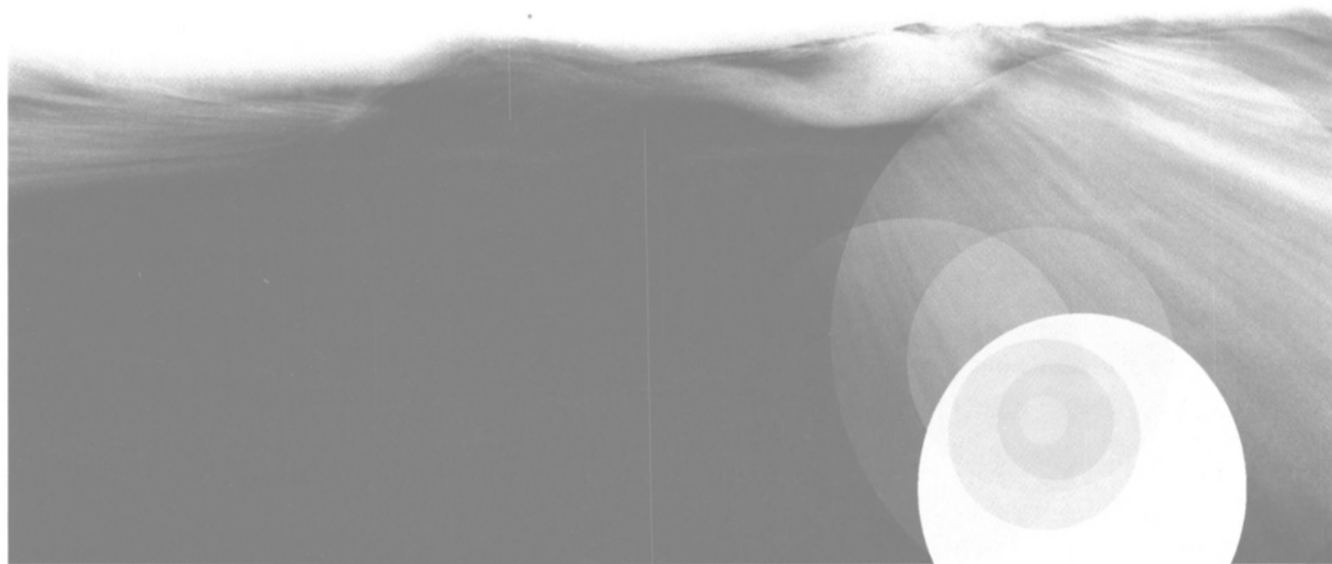

Whether your business is shipping, exploration or humanitarian assistance, you depend on reliable communications. This has been our business for more than 20 years. *SAIT Communications* and *Telenor Satellite Services - Retail* have now merged into one global company with a personal approach. We at *Marlink*, provide our customers high-quality and reliable services, around the clock and around the world.

# MARLINK.

Mobile Satellite Communication  
*Marlink - communications you can rely on*

**inmarsat**

[www.marlink.com](http://www.marlink.com)

Circle 302 on Reader Service Card or visit [www.maritimereporterinfo.com](http://www.maritimereporterinfo.com)

# Optimal Electric Ship Propulsion Solution

By Stuart C. Karon,  
American Superconductor

Throughout the history of shipbuilding, the key challenge too often has been how to build the right ship around a given propulsion system, rather than creating tailored propulsion system for the ship. That was true when the best propulsion "engines" available were sails, and it is also true for today's diesel, gas turbine and electric hybrid systems as well.

The ideal, of course, is to allocate cargo space, cabin space, the shape of propulsion units, and even the shape of the ship's itineraries around the needs of the marketplace rather than around the limitations imposed by the ship's propul-

sion system. Factors that remain in the path of that ideal include the underlying efficiency across a broad operational range with which chemical energy is turned into mechanical energy, and the ability to allocate space in the most profitable manner. In other words, if you can dramatically improve the power densities of marine propulsion motors and generators as well as their efficiencies; i.e. make these efficiencies much higher and more uniform at varying loads, many of the other issues would be resolved too — and ship design need not be compromised.

In fact, with continuing improvements in power density and efficiency, electric drive propulsion systems are projected to displace mechanical drive systems

across a broader spectrum of applications.

The maturation of HTS rotating machine design coupled with the upcoming U.S. Navy-sponsored 5 MW prototype motor development and testing indicate that high temperature superconducting (HTS)-based propulsion systems represent a near-term solution to these long-standing challenges. Motors and generators employing HTS wire are very compact in size and low in weight. These qualities make them easier to site in the ship, allows more modular ship construction, and reduces undesirable tradeoffs that face many ship designers. Naval architects can now begin to translate these propulsion system improvements into increased profitability for ship owners and operators.

## The Challenge

Even in modern ships, propulsion systems are so large and heavy that in many applications they force the rest of the ship to be constructed around them. Machine sizes and their locations also reduce the space available for cargo and passengers and interfere with efficient loading and unloading. Shafts can extend considerable lengths, further compromising efficient space utilization. Additionally, the propulsion systems, both mechanical and electrical, used in virtually all ships today operate less efficiency at lower speeds — creating excess costs on shorter routes and eliminating the use of some otherwise desirable ports.

All these issues carry associated costs. Installing propulsion systems so early in the ship's construction increases the cost of capital and reduces the builder's ability to use the most efficient shipbuilding practices. Less usable internal volume decreases the revenue generation potential for commercial vessels as well as the war-fighting capability for military ships. Inefficient loading and unloading create longer cycle times, increase port costs, and jeopardize schedules. Prolonged and low speed operation of diesel direct-drive and geared propulsion systems increases maintenance costs. Reduced efficiency at low ship speeds may make certain shipping routes

The small strips of HTS wire carry the same current as the much larger and heavier copper cable.

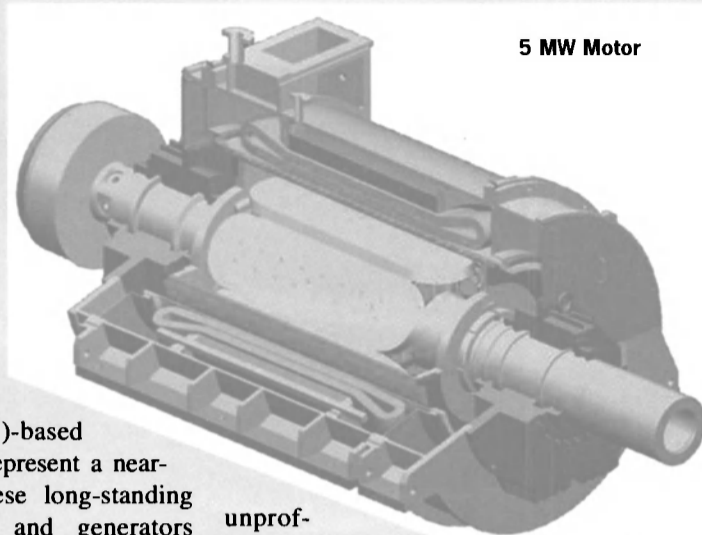

5 MW Motor

unprofitable compared with other transportation alternatives. The shift to diesel electric propulsion systems addressed some of these issues. Electric motors can be located further aft in a ship, freeing naval architects from the "tyranny of the shaft-line," giving ship designers almost unlimited flexibility in the ship arrangements. The length of the drive train is reduced, as is the requirement to maintain strict alignment requirements over long lengths from the prime mover to the propeller. For ships that incorporate podded propulsors, this length is reduced to zero. These externally mounted motors maximize a ship's hydrodynamic efficiency and its usable internal volume for revenue generation. Podded propulsors also reduce shipbuilding costs through increased modularity during construction. Ships today tend to consume more electricity than did their predecessors. Integrated electric propulsion systems optimize ship operators' flexibility through the ability to only use the minimum amount of electricity generation equipment for a given operational scenario. The generators may therefore be operated closer to their full outputs and unneeded machines shut down, which increases the overall system efficiency and minimizes maintenance requirements.

It is because of advantages like these that nearly all cruise ships and many other ship types including shuttle

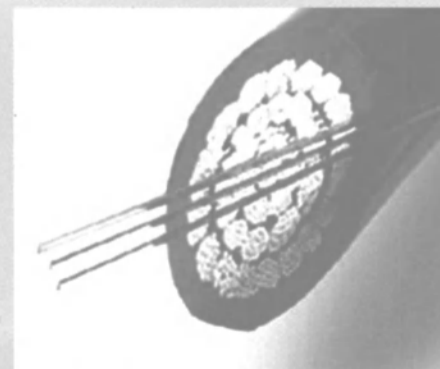

## NLB HydroPrep™

# Cruise through surface prep.

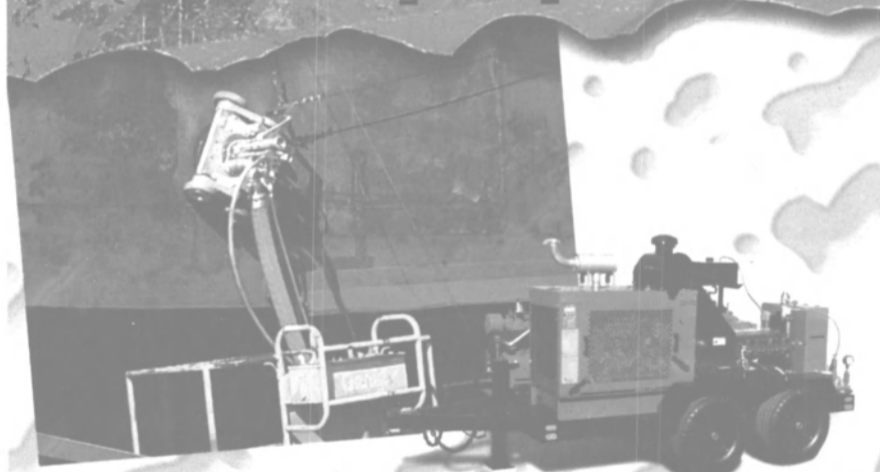

Big surface prep jobs are easy with NLB's HydroPrep™ system. It outperforms grit blasting and other UHP water jet equipment, minimizing hazards and giving you:

- unsurpassed reliability;
- lower operating costs;
- greater maneuverability; and
- simpler operation and maintenance.

The HydroPrep™ system includes an SRT-10 Crawler, UHP pump, vacuum recovery, console, and rigging. Call today for a free demo... in North America, call toll-free: 1-877-NLB-7990.



**NLB North America**  
29830 Beck Road  
Wixom, MI 48393, USA  
Phone: 01-248-624-5555  
Fax: 01-248-624-0908  
e-mail: nlbmtg@nlbusa.com  
www.nlbcorp.com

**NLB Europe**  
Gentianenlaan 17  
3233 VC Oostvoorne, Netherlands  
Phone: 31 (0) 181-482811  
Fax: 31-(0) 181-485238  
e-mail: watercle@publishnet.nl

Circle 349 on Reader Service Card  
or visit [www.maritimereporterinfo.com](http://www.maritimereporterinfo.com)

tankers, product carriers, ferries, ice-breakers, and offshore oil exploration platforms have made the transition to integrated electric propulsion systems, in both in-hull and podded propulsion variants. In addition, 13 navies of the world have either modern electrically propelled ships, are already designing/constructing electrically propelled ships, or have announced plans to initiate such programs. Prominent among these is the U.S. Navy, which in 2000, announced that its next generation of surface combatant ships will have electric propulsion systems. Although they are an improvement over their predecessors, modern electric drives still have not presented an ideal propulsion solution for shipbuilders across a wide range of applications. Electric propulsion motors at higher power levels can be large and heavy, which limits their flexibility in placement within the ship. In propulsion pod applications, this large size and weight provide an upper bound to the pod's applicability, apparently around 20 MW. In addition, today's electric propulsion motors have significantly reduced efficiencies at lower ship speeds, thereby failing to take best advantage of one of their primary attributes — reduced fuel consumption when compared to low speed diesel engines operated at low power levels.

**Improving Energy Transformation Efficiency and Power Densities**

Unlike the force of gravity or the speed of light, the efficiency of mechanical/electrical energy transformation is not a universal constant. Efficiency is a function of variables that have been well known for decades, including the geometry of the motor or generator, the presence or absence of an iron core in its rotor, the material from which the wire in the rotor coils is composed and so forth. In fact, the variable found to have the biggest impact on efficiency is the rotor coil winding material. The maturation of electrically loss-less ceramic materials, known as high temperature superconducting (HTS) wires, has dramatically improved rotating machine efficiencies, and allowed their designs to be modified so that they can now be built at a fraction of previous sizes and weights.

Just as optical fiber transmits data much better than copper does, so too can ceramic fila-

ments transmit electricity much better than copper. The difference is that optical systems must plug into special adaptive electronics, while motors and generators using HTS wire plug into the same grid and operate in exactly the same way as their copper-based counterparts.

Electric propulsion motors using coils made with HTS wires are just a lot

lighter and smaller for a specified power output, and more efficient at all loads. This makes them easier to site in the ship, allows more modular ship construction, and reduces undesirable trade-offs that face many ship designers. HTS motors in larger power ratings will fit easily into external pods, for example, and therefore simplify the shipbuilding

process. The only consideration for these HTS motors and generators is that they require a small, commercially available refrigeration system to cool the HTS wires. These refrigerators are similar but less complex than those used satisfactorily in thousands of medical

*(Continued on page 54)*

**The most advanced sterntube lubricants in the world**

Why do so many ship operators insist on HYDROX for sterntube lubrication? Because they know that even if water enters their vessel due to seal damage, they can continue to sail on course and on schedule without expensive emergency repairs.

• Readily Biodegradable  
• Non Toxic to the aquatic environment  
• WGK rating 1

Airedale Mills 6 Clarence Road Leeds LS10 1ND England.  
Tel: 44 (0) 113 386 7654 Fax: 44 (0) 113 386 7676  
Email: [inbox@vickers-oil.com](mailto:inbox@vickers-oil.com) Web: [www.vickers-oil.com](http://www.vickers-oil.com)

Lloyd's Register  
PRODUCT VERIFICATION

Circle 212 on Reader Service Card or visit [www.maritimereporterinfo.com](http://www.maritimereporterinfo.com)

**STERLING RWO**

**TURNKEY WATER TREATMENT SOLUTIONS ONBOARD SHIPS**

**MARINE WATER TREATMENT SYSTEMS**

- Potable Water
- Technical Water
- Swimmingpool water
- Waste Water
- Bilge Water
- Grey Water
- BLACK Water

**TOTAL WATER MANAGEMENT ONBOARD SHIPS**

- Seawater Desalters
- FW - Generators & RO Reverse Osmosis
- Filtration with autobackflush
- UV-Sterilisers
- Chlorination & Dechlorinators
- Hardening & Softening
- Ion exchangers
- Mineralisation & Demineralisation
- Swimmingpool Water Treatment
- Bunker Water Treatment

**RWO Water Technology**  
Leerkampe 3 • D-28259 Bremen • Germany  
Tel: + 49-421-53 70 50 • Fax: + 49-421-53 70 540  
E-mail: [RWO.Bremen@T-Online.de](mailto:RWO.Bremen@T-Online.de) • <http://www.Sterling-RWO.com>

Member of the Sterling Fluid Systems Group  
<http://www.Sterlingfluidsystems.com>

# New Technology Has Promising Maritime Applications

Millennium Cell Inc., which designs and develops systems for the safe use of hydrogen fuel in energy applications, has teamed with Seaworthy Systems in a CCDOTT (Center for Commercial Development of Transportation Tech-

nologies) and California State University, Long Beach Foundation program. This program will demonstrate the benefits of using its fuel to power ships and facilities in ports. The project is designed to meet CCDOTT goals for

zero emissions from fuel cells, and the contract award comes as many operators in U.S. ports are facing potential fines for being well in excess of Environmental Protection Agency air and water quality standards.



"So there's a movement afoot right now in California to add regulation to reduce emission for all of the maritime fleet," said **Rex E. Luzader**, vice president of Business Development for Transportation and Hydrogen-Fuel Infrastructure at Millennium Cell. "We're going to see more and more potential applications where hydrogen is either used in fuel cells to provide electricity with zero emissions or to burn in internal combustion engines for propulsion power with extremely low emissions."

Founded in 1998, Millennium Cell has invented and developed a proprietary process called Hydrogen on Demand that is designed to safely generate pure hydrogen or electricity from environmentally friendly raw materials. Sodium borohydride is made from borax, a material that is found in substantial natural reserves globally, with a particularly large supply in the U.S., prompting Millennium Cell to call their fuel, Freedom Fuel.

The Hydrogen on Demand system releases the hydrogen stored in the chemical bonds of sodium borohydride solutions by passing the liquid through a chamber containing a proprietary catalyst.

The reaction is totally inorganic, producing a high-quality energy without polluting emissions. Hydrogen is only produced — on demand - when the liquid fuel is in direct contact with the catalyst, thereby minimizing the amount of gaseous hydrogen present in the system at any given time. The fuel solution itself is nonflammable, non-explosive and safe to transport, minimizing many of the logistical issues associated with hydrogen.

### Hydrogen on Demand™ Typical System Schematic

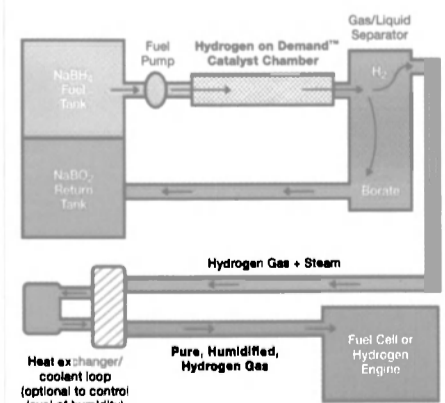

You're always out in front with FLOW waterjets —now even faster at 55,000 psi

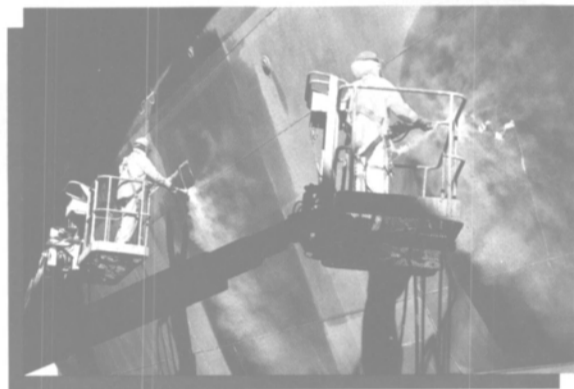

You need the best available equipment to stay competitive in this business. FLOW knows. We lead the waterjet industry in:

#### Productivity

Remove coatings faster with FLOW's HUSKY® pump running at 55,000 psi, the highest operating pressure available.

#### Reliability

FLOW has more pumps in the field than all other UHP waterjet manufacturers combined, with over 1 million total working hours.

#### Low Operating Costs

FLOW's HydroCat® is proven in the field to remove tough coatings faster than grit blasting, without the added cost of grit containment and disposal.



Flow International Corporation has developed every major advance in the field of waterjet technology and is the world's leading manufacturer of ultrahigh-pressure (UHP) waterjet equipment.

Flow 1-800-446-3569 • www.flowcorp.com

Circle 335 on Reader Service Card or visit [www.maritimereporterinfo.com](http://www.maritimereporterinfo.com)

### Worldwide spare parts deliveries for the ship department

on time

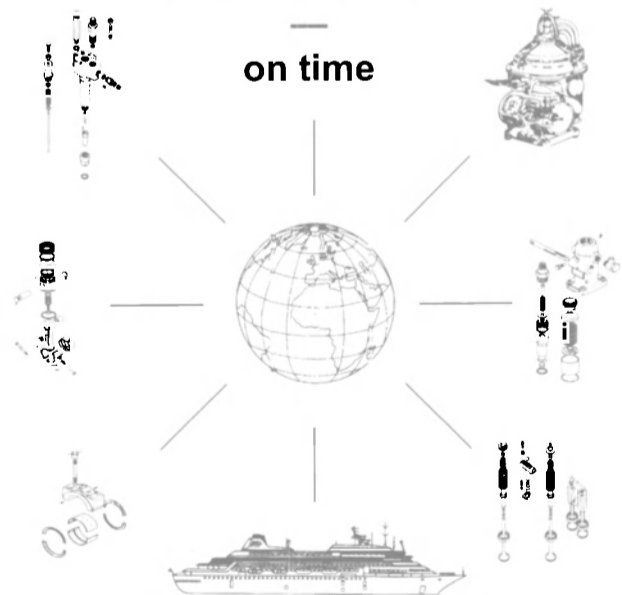

See us at SMM, Stand No. 5002

## MOTOR-SERVICE AB

Stationsvagen 4 • SE-144 61 Ronninge • Sweden  
Phn: +46 8 532 535 42, +46 8 532 551 40 • Fax: +46 8 532 544 51  
[www.motorservice.se](http://www.motorservice.se) • [sales@motorservice.se](mailto:sales@motorservice.se)

Circle 266 on Reader Service Card or visit [www.maritimereporterinfo.com](http://www.maritimereporterinfo.com)

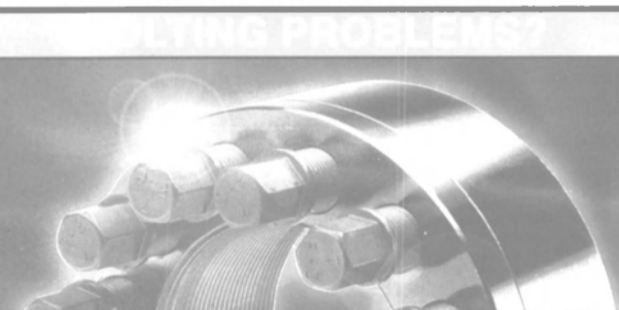

Superbolt® stud/bolt tensioners will not loosen. Tensioners remain tight on vibrating, pulsating or reciprocating equipment.

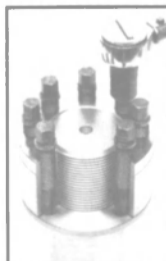

#### Benefits

- Only hand tools required
- Replaces existing nuts
- Fast - Saves man-hours / downtime
- More clamping force
- Greater preload accuracy
- No thread galling
- Safe to use
- Eliminates hazardous and time consuming bolting methods

## SUPERBOLT®

PO Box 683 • Carnegie, PA 15106  
1-800-345-BOLT • 412-279-1149 outside US  
FAX 412-279-1185 • [www.superbolt.com](http://www.superbolt.com)

For more information, call for a free copy of our catalog and video

Circle 298 on Reader Service Card or visit [www.maritimereporterinfo.com](http://www.maritimereporterinfo.com)



# CHALLENGE:

Improve the maneuverability of the "Anna", a 230' class liftboat with a 70' beam, where conventional tunnel thrusters would not be an option.

# SOLUTION:

A TRAKTOR® JET 864 HT 360 degree flush mounted thruster was installed, the first marine jet thruster to be used in this type of vessel. The shipyard has reported that the TRAKTOR® jet has exceeded their expectations.

For a solution to your marine propulsion challenge,  
**CALL 501-778-4151.**



*Photo compliments of Conrad Shipyards, LLC.*

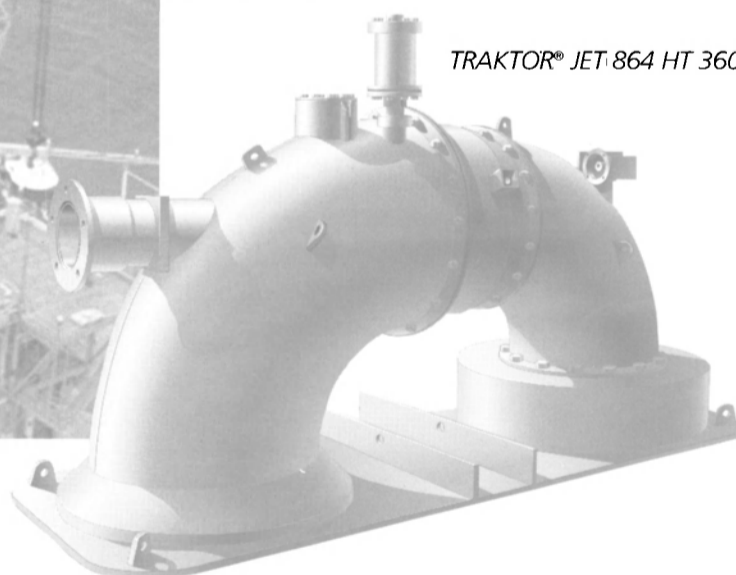

*TRAKTOR® JET 864 HT 360 Degree Thruster*



## **North American Marine Jet**

*Manufacturers of pleasure, commercial and military marine jet products*

P.O. Box 1232 • Benton, Arkansas USA 72018

501.778.4151 • Fax 501.778.6381

E-mail: [namj@marinejet.com](mailto:namj@marinejet.com)

Website: [www.marinejet.com](http://www.marinejet.com)

Circle 270 on Reader Service Card or visit [www.maritimereporterinfo.com](http://www.maritimereporterinfo.com)

How Millennium Cell's Hydrogen On Demand™ System Works

On-Board Energy-Releasing System:



40-55% NaBH<sub>4</sub> solution stabilized w/ 1% LiOH  
 - oxygen  
 catalyst  
 hydrogen production  
 Metaborate  
 "flux" if aqueous solution with NaOH  
 Pure hydrogen H<sub>2</sub> delivered to a fuel cell

Millennium Cell technology can be applied in transportation and portable power, including micro-power and longer-life batteries. This unique fuel system gives the Natrium a range potential of 300 miles, significantly longer than any fuel cell vehicle shown to date.

In addition, the vehicle has zero emissions — no greenhouse gas or smog-forming compounds. The system can be used with fuel cells and diesel or gas turbine engines.

"Millennium Cell is providing visionary leadership in developing hydrogen

fuel solutions for transportation, stationary and portable power and we are excited about the opportunity to assess the merits of the Hydrogen on Demand system in maritime applications — including hydrogen-powered fuel cells and internal combustion engines," said **Matthew Winkler**, vice president of Seaworthy Systems.

Luzader said the Hydrogen on Demand system has a variety of maritime uses. "It could be any application from propulsion to onboard electrical generation or anything in between," he said. "It could be backup power or distributed generation where you have multiple units on board serving various sections of the ship. Containerships could be towed into port by a clean-fuel vessel."

Another promising use of Hydrogen on Demand is in military applications, said Luzader. The use of an energy-dense fuel source that is nonflammable and non-explosive would be a tremendous asset to military on land and at sea.

"We've had discussions with the Naval Surface Warfare Center where, if they used fuel cells as the source of energy for propulsion, one possibility is that they could use our fuel as the source of hydrogen for the fuel cell," he said. "We could actually regenerate the fuel or the borate solution at sea and eliminate the supply chain. The ability to regenerate fuel at sea with the fleet is a unique proposition for the Navy that no other technology offers."

"They're operating on one possible premise that, beyond 2050, there may not be diesel fuel available for burning on board ship to generate power for propulsion," Luzader said. "So they're looking at other alternatives to produce propulsion power, and fuel cells would be one. Our technology would be an advantageous source of hydrogen for the fleet. The concept would be one in which you would have a ship within that fleet that would actually make sodium borohydride from the borates made aboard all the ships in that fleet powered by fuel cells using Hydrogen on Demand as the source of hydrogen. That's the program we've got on the table for consideration for the Navy of tomorrow."

Dr. **Stephen S. Tang**, president and CEO of Millennium Cell, said, "We expect the demonstration of the Hydrogen on Demand system in maritime applications will show how efficiently we can reduce air and water pollution in our seaports and waterways and provide a clean energy solution to help solve complex environmental issues."

For more information on Millennium Cell Circle 58 on Reader Service Card [www.maritimereporterinfo.com](http://www.maritimereporterinfo.com)



# IN PURSUIT OF MANOEUVRABILITY

Aspiring to provide excellent systems, Kawasaki, with a century-long experience, is continually researching and developing new propulsion systems.

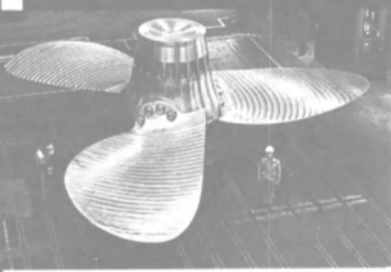
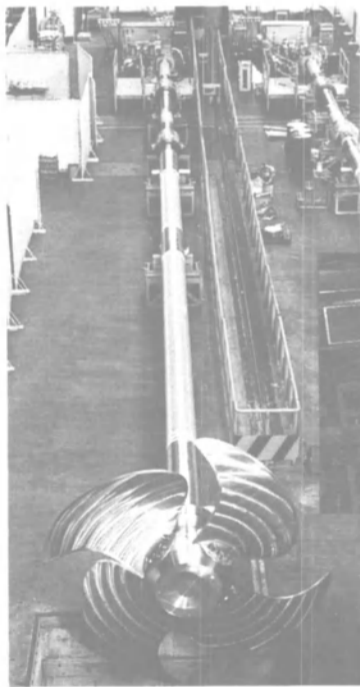

C.P. PROPELLER

REPELLER

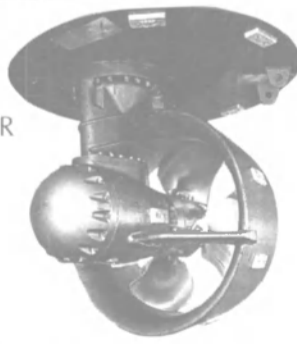

INTEGRATED CONTROL SYSTEM

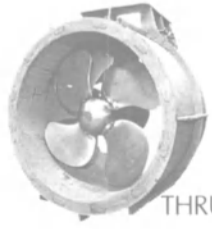

SIDE THRUSTER



World Trade Center Bldg., 4-1 Hamamatsu-cho, 2-chome, Minato-ku, Tokyo 105-6116, Japan  
 ●Marine Machinery Sales Dept. Machinery Division: Phone: 81-3-3435-2374 Fax: 81-3-3435-2022  
 Kawasaki Heavy Industries (UK) Ltd. Phone: 44-20-7588-5222 Fax: 44-20-7588-5333  
 Kawasaki Heavy Industries (Europe) B.V. Phone: 31-20-644-6869-70 Fax: 31-20-642-5725  
 Kawasaki Heavy Industries (USA) Inc. Phone: 1-212-759-4950 Fax: 1-212-759-6421

Circle 251 on Reader Service Card or visit [www.maritimereporterinfo.com](http://www.maritimereporterinfo.com)

It's easy to explain why the arguments in favor of Geislinger are infinite:



because our innovative couplings and dampers are a step ahead of time and built to last and last and last.



Geislinger GmbH  
A-5300 Hallwang/Salzburg, Austria • Hallwanger Landesstr. 3  
Tel. +43/662/669 99-0 • Fax +43/662/669 99-40

**North America:**

Geislinger Corporation  
200 Geislinger Drive • Battle Creek, MI 49015-5622  
Tel. +1/269/441 7000 • Fax +1/269/441 7001

info@geislinger.com • www.geislinger.com

Circle 233 on Reader Service Card or visit [www.maritimereporterinfo.com](http://www.maritimereporterinfo.com)

**GEISLINGER** 

COUPLINGS AND DAMPERS. BUILT TO LAST.

# Recent Wärtsilä Four-Stroke Engine Developments

Wärtsilä has focused its technological developments in this realm on three main areas: Common-rail fuel injection for heavy-fuel engines; Humidification

methods for reduction of NOx; and Dual-fuel engines with micro pilot. Long-term research on the concepts hot combustion for combined cycles and

steam injected diesel is also going on.

## Common-Rail Fuel Injection

Three engine types, i.e. the Wärtsilä

46, Wärtsilä 38 and Wärtsilä 32 have - so far - been made available for the common-rail injection systems. The pilot engine, which sails onboard the Carnival Spirit, has to date gathered more than 3,500 hours of operational experience, and the Wärtsilä 46 test engine has more than 3,000 hours as well. While there has been a normal amount of teething problems, the experience so far has proven that the basic concepts of the Wärtsilä common-rail system are sound.

The accumulator architecture (Figure 1) has proven very successful in providing excellent pressure stability, meaning that every injection starts from the same rail pressure.

The rail pressure control by linear solenoid valves on the injection pump (Figure 2) provides even better than expected rail pressure accuracy, i.e. the rail pressure is maintained at + 35 bar, while + 100 bar would have been still

## BRUNVOLL THRUSTER SYSTEMS



**4000 THRUSTERS**  
delivered  
and more than  
2200 Ships  
equipped with  
**BRUNVOLL**  
**THRUSTERS**

BRUNVOLL ARE PRODUCERS OF  
Tunnel Thrusters  
Azimuth Thrusters  
Low noise Thrusters  
Control Systems

*Tailor-made Thrusters for Tailor-made Ships*



# BRUNVOLL

BRUNVOLL AS • 6415 MOLDE • NORWAY

TELEFON + 47 71 21 96 00  
FAX + 47 71 21 96 90  
e-mail: office@brunvoll.no  
www.brunvoll.no

Circle 214 on Reader Service Card or visit [www.maritimereporterinfo.com](http://www.maritimereporterinfo.com)

**The leading system expert  
in power plants and  
marine industries**

Auramarine fuel oil supply systems, auxiliary units and catalytic converters for power station and marine industries are designed and manufactured from the beginning so that they fit seamlessly to the customer's system. Serial production economics and the high quality of tailored manufacturing are combined in Auramarine products.

### AUXILIAR



AMT transfer pump unit for fuel pumping from storage to settling tank



PHU preheating unit for warming up the engine

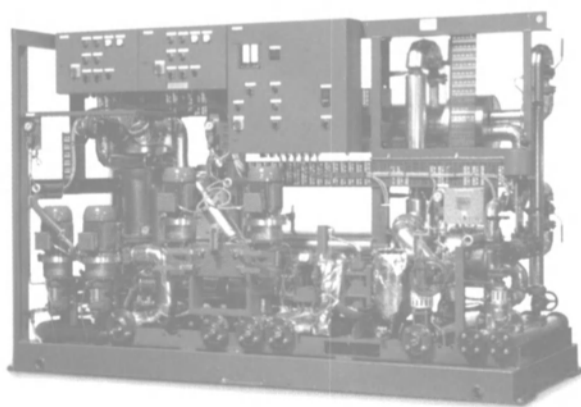

AMB feeder booster for pressurised heavy fuel oil filtration, heating and feeding

### CATALYTIC CONVERTERS



Combined OxiCat and silencer



**AURAMARINE**  
P.O. Box 849  
FIN-20101 TURKU  
FINLAND

Tel. +358 (0)2 414 2200  
Fax +358 (0)2 414 2250

[www.auramarine.fi](http://www.auramarine.fi)

**Before and After Engine**

Circle 209 on Reader Service Card or visit [www.maritimereporterinfo.com](http://www.maritimereporterinfo.com)

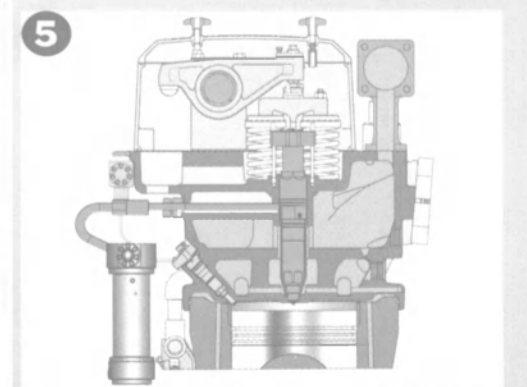
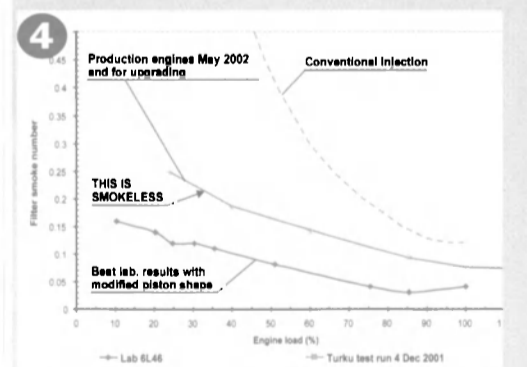
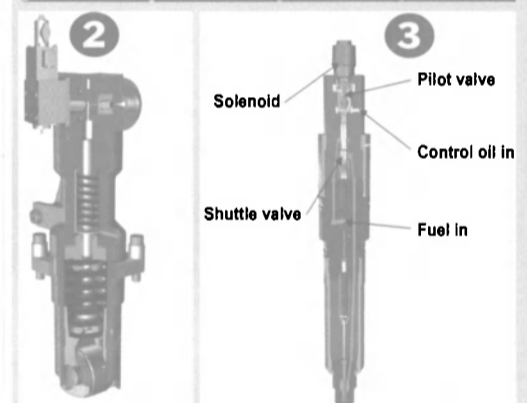
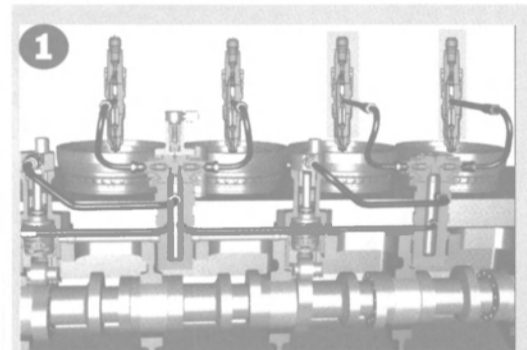

acceptable.

The injector with the shuttle valve and the press-down piston for the injector needle provides together with the flow fuse total safety against early introduction of fuel into the cylinder. The press-down piston also contributes to excellent smoke behavior. (Figure 3)

The target of smokeless operation at all loads and load pick-up has been reached (Figure 4), and laboratory tests have proven that there is further potential to do even better. Wartsila 46 engines with common-rail injection systems for five cruise vessels have been delivered so far. The first Wartsila 32 common-rail engines are due for delivery shortly, and during the autumn the first Wartsila 38 engines will be retrofitted into common rail.

**Humidification for Reduced Nox**

Direct Water Injection used to be the Wartsila method for combustion air

humidification. The system has been developed for common rail engines with side-mounted injector (Figure 5). This configuration is now in field test. The Combustion Air Saturation System (CASS) (Figure 6) has been further tested, and a pilot installation on a Wartsila 32 engine will go into operation this autumn. The system is also being quali-

fied for the Wartsila 46 engine, and further engine types are likely to follow. The first systems are sold for half the NOx value compared to Marpol Annex VI curve.

Fuel-water emulsion is not promoted for engines with conventional injection systems. With common-rail fuel injection most of the disadvantages are elim-

inated. Compared to conventional injection systems the common rail offers the following advantages:

- Full load can be reached without increased camshaft torque. In fact the camshaft torque of a common-rail engine is always much reduced compared to conventional engines.
- There will be no risk of cavitation in

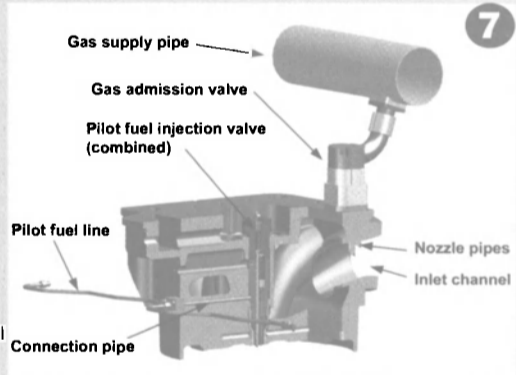
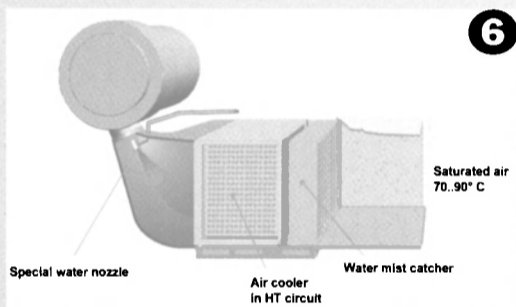

1 The accumulator architecture (Figure 1) has proven very successful in providing excellent pressure stability, meaning that every injection starts from the same rail pressure.

2 The rail pressure control by linear solenoid valves on the injection pump (Figure 2) provides even better than expected rail pressure accuracy.

3 The press-down piston also contributes to excellent smoke behavior.

4 The target of smokeless operation at all loads and load pick-up has been reached (Figure 4), and laboratory tests have proven that there is further potential to do even better

5 Direct Water Injection used to be the Wartsila method for combustion air humidification. The system has been developed for common rail engines with side-mounted injector

6 Wartsila Combustion Air Saturation System CASS.

7 Wartsila DF pilot fuel and gas system



**BERG**

P R O P U L S I O N

Box 1005 Phone: Fax: E-mail: Website:  
 S-430 90 OCKERO +46-31-97 65 00 +46-31-97 65 38 info@bergpropulsion.se www.bergpropulsion.se  
 SWEDEN

For Emergency call our 24-hour International Service Pool +44-31-96 94 62

Circle 271 on Reader Service Card or visit [www.maritimereporterinfo.com](http://www.maritimereporterinfo.com)

## Marine Propulsion Annual

the high-pressure pump, because the pressure relief process is not taking place in a common-rail high-pressure pump.

• It is possible to optimize the engine both for fuel-water emulsion and pure fuel as different timings and durations can easily be used in both cases.

The NOx reduction of water-fuel emulsion alone might not be very interesting in the current world, because it is limited to 20-25 percent. The reason for Wartsila's interest is mainly because of the opportunity to reach ultralow NOx emissions by a combination of Combustion Air Saturation and Fuel-Water

Emulsion. A patent application for this combination has been filed.

### Dual-Fuel Engine With Micro Pilot

The dual-fuel engine with micro pilot has demonstrated itself as a surprisingly successful concept. Although the micro pilot injects only one percent of the full-

load fuel, the igniting capacity of the pilot spray is thousands of times better than from a spark plug. This means that good combustion stability can be reached with leaner mixes, which again allows for higher compression ratios, resulting in high efficiency and improves the possibility to run good performance in the gas mode and in the diesel mode in the same hardware.



**TANO** has a 35 year tradition in providing marine automation systems using the latest technologies to assure lower operating costs. We specialize in tailoring a system to meet the specific needs of the vessel and to maximize the value to the customer.

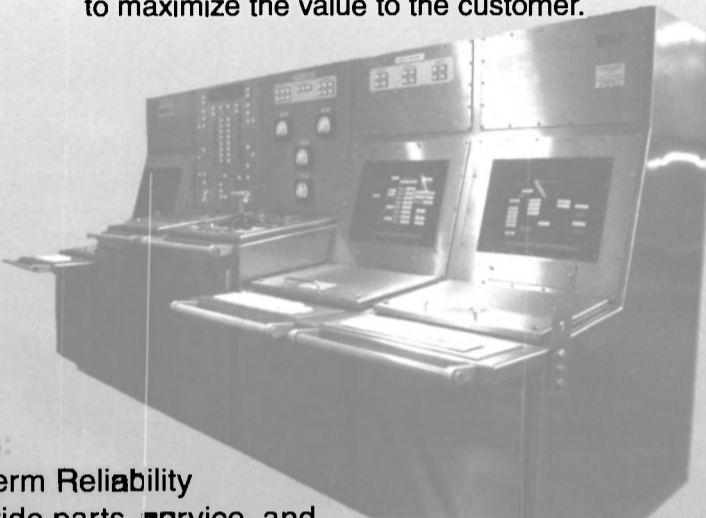

### Installed Systems Include:

- Propulsion Control
- Steering Control
- Cargo/Ballast Control
- Electrical Monitoring and Control
- Simulators and Trainers

### Benefits:

- Long Term Reliability
- Worldwide parts, service, and training support
- MIL-Spec and Commercial
- New Construction and Retrofits

1-800-229-TANO

[www.tano.com](http://www.tano.com)

**TANO Corp.**  
5700 Citrus Blvd., Ste E  
New Orleans, LA 70123  
Phone: 504/733-4777  
Fax: 504/734-2127  
Singapore Office  
Phone: 65-296-5421  
Fax: 65-296-0451

Circle 333 on Reader Service Card or visit [www.maritimereporterinfo.com](http://www.maritimereporterinfo.com)

## Introductions & Updates

### Wartsilä 50DF

While the Wartsila 32DF has been on the market for some time, the first installations are at about 20,000 running hours, the Wartsila 50DF is a new product introduction. This engine is based on the diesel engine Wartsila 46. It offers a cylinder output of 950 kW. The shaft efficiency in gas mode is 47 percent, which is probably a current world record for gas engines. As has been earlier reported, the 50DF has made a breakthrough into the LNG tanker market.

### Wartsila 38B

With more than 60 engines sold, the Wartsila 38B is not exactly a new product introduction, but the fact that this engine is now available also with common-rail fuel injection makes it worth mentioning. The cylinder output of this engine is 725 kW. A test engine is currently being installed in the research center in Trieste. During the autumn the focus will be on endurance testing of the common-rail equipment.

### Wartsila 32 with Increased Output

The Wartsila 32, which is the successor of the Vasa 32, has now been on the market for some time, and with more than 300 engines sold and the first engines passing 25,000 running hours, the engine is now ready for an output increase into 500 kW per cylinder.

### Wartsila 64

An excellent piece of experience can be reported from the Wartsila 64, of which the first engines to go into operation are now approaching 20,000 hours. Thirteen engines are — at the moment — in operation, and up to now in total 12 hours of non-availability have been recorded. Most of those hours were due to a mishap with parts logistics. Mathematically this means that the availability has been more than 99.9 percent and the mean time between failures is calculated to more than 5,000 hours. The step from the Wartsila 46 with 1 MW per cylinder into the Wartsila 64 with 2 MW per cylinder was certainly a big one, and for that reason no effort was spared in terms of numerical calculations and simulations.

Circle 64 on Reader Service Card  
[www.maritimereporterinfo.com](http://www.maritimereporterinfo.com)

# DRIVING FORCE!

Our name has changed. But you can still expect great people, the best service and the highest product quality.

Around the world, Wartsila propulsors, seals, and complete propulsor systems provide power, maneuverability and control systems for vessels ranging from pleasure craft and river tugs to the largest cruise ships, supertankers and aircraft carriers.

More than 60 navies, including the US Navy, rely on Wartsila to keep their vessels mission-ready 24/7.

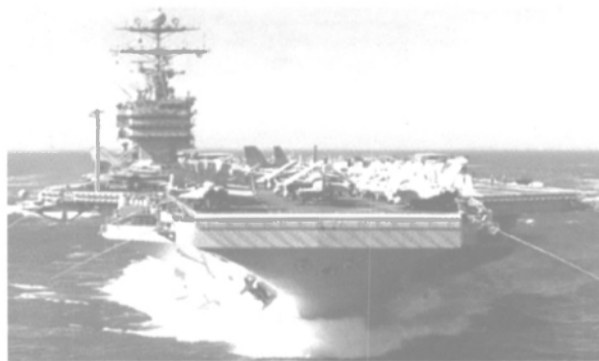

### Wartsila Lips, Inc.

3617 Koppens Way, Chesapeake, VA 23323  
24/7 Sales/Support/Service 757-485-5275 Fax 757-487-3658

SERVICE CENTERS: Chesapeake, VA; New Orleans, LA; Pearl Harbor, HI; Seattle, WA  
SALES OFFICES: Chesapeake, VA; New Orleans, LA; Houston, TX; San Diego, CA; Seattle, WA; Portland, MA

Circle 324 on Reader Service Card or visit [www.maritimereporterinfo.com](http://www.maritimereporterinfo.com)

## CMR: Monitoring is Control

CMR, which offers specialized systems for monitoring industrial and marine engine parameters, introduces the Clarine line to the marine industry, including the Clarine Marine Rack 101, which provides several advantages to shipbuilders. CMR's Clarine Marine Rack 101 is a centralized device designed to eliminate the need for separate monitoring and alarm units.



Designed to mount flush in the wheelhouse console, the Rack 101 features

standard display formats for a traditional "console look" on a 12-in. (305 mm) LCD screen. It also has an integrated logic functions and can replace PLCs on workboats, OSVs and crew boats and tugs. Additionally, a black box function records all monitored events for remote viewing. Clarine monitoring systems enable acquisition, processing and LCD display of parameters transmitted on a CAN-Open network. This eliminates most of the complicated wiring on the ship and reduces labor during construction and long-term maintenance. Completely self-contained, the Rack 101 system is designed for use in harsh environments and can be integrated into any CAN-Open network. Designed for local and networked monitoring of engines, gen-sets and the complete alarm list, the Clarine system processes up to 200 analog channels and generates an alarm when any of several specified thresholds is exceeded.

Circle 60 on Reader Service Card  
[www.maritimereporterinfo.com](http://www.maritimereporterinfo.com)

## GE Gas Turbines on Brilliance of the Seas

GE LM2500+ combined gas turbine and steam turbine integrated electric drive system (COGES) plant powers

## New Fireproof, Sound Absorbing Foam

A British company is introducing a new range of fire-resistant sound absorption foams to the U.S. market. Designed specifically for marine applications, the product

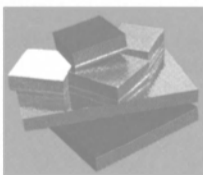

is manufactured by Siderise (Special Products) Ltd. The foams weigh between 22 and 176 lbs./cu. m., and are supplied with 10 types of facing, ranging from reinforced foil through to spray-applied PVC. The product comes with a self-adhesive backing made from a pressure-sensitive high-specification acrylic tape that, once applied, will become a permanent fixture. The foams can be supplied with a built-in acoustic barrier, with either a lead or a mineral-loaded polymeric base. The acoustic barrier system, the company says, can offer up to 28 dBA of sound reduction in the engine room.

Circle 73 on Reader Service Card  
[www.maritimereporterinfo.com](http://www.maritimereporterinfo.com)

Royal Caribbean International's 90,900-gt, 962-ft. (293.2 m), 2,100 passenger Brilliance of the Seas cruise ship, which recently made its maiden voyage. The 25-knot ship features a COGES arrangement with two GE LM2500+ gas turbine-generators and one steam turbine-generator set for a total output of 59 MW. This electric drive configuration

provides for both main ship propulsion as well as all onboard power generation.

The LM2500+ COGES ships operate on clean distillate fuel to significantly reduce emissions of most airborne pollutants and other particulates, as compared to a diesel electric power system operating on heavy fuel oil, which is customary for most cruise ships.

Including the 12 LM2500+s aboard the six Royal Caribbean/Celebrity Cruises ships, GE has delivered a total of 19 gas turbine-generator sets for 12 cruise ships. Of these, 17 are driven by GE



# TCA Turbocharger

The new generation

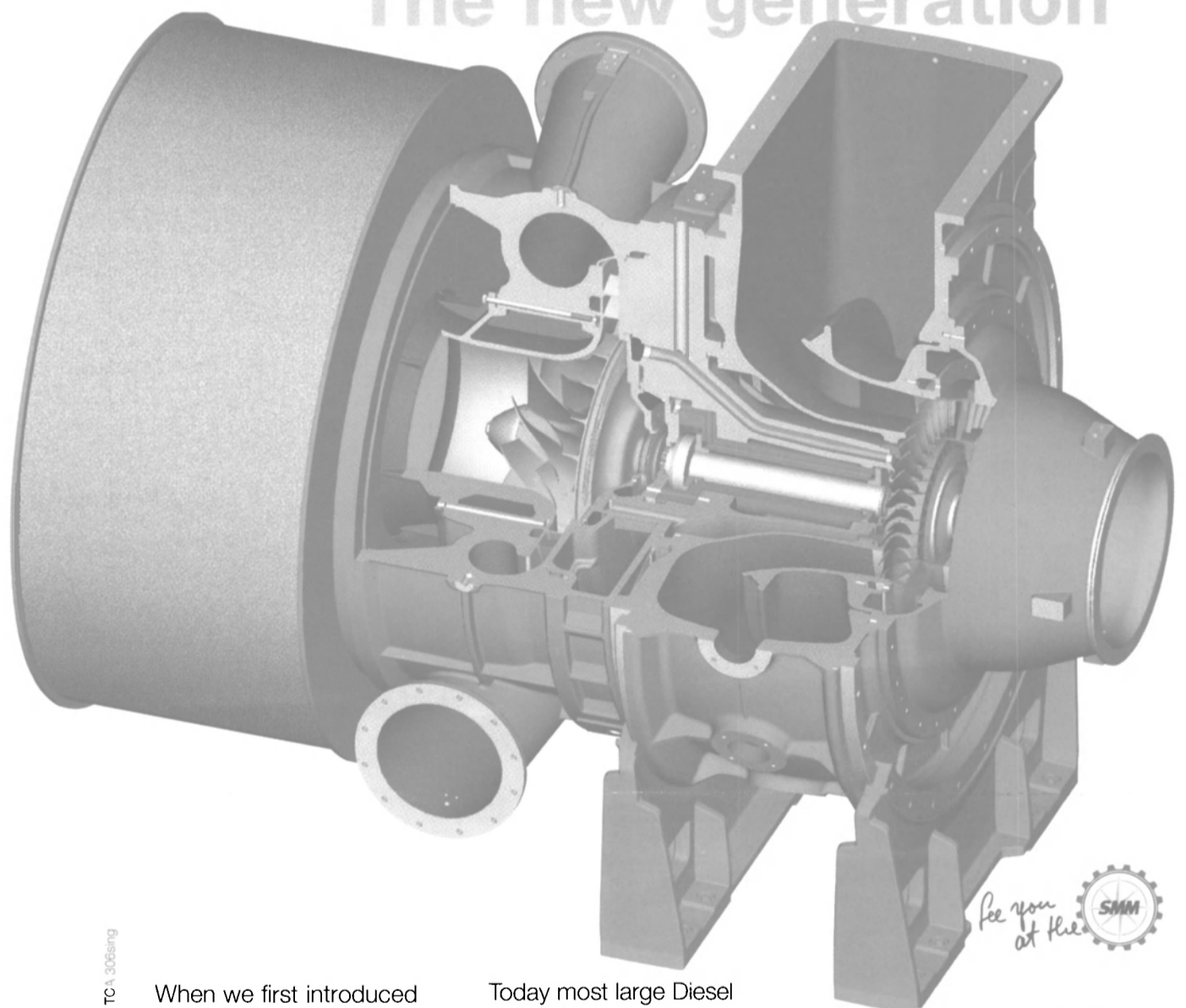

TCA 306eng

When we first introduced the reliable and maintenance-friendly turbocharger concept with inboard plain bearings and uncooled turbine casings 60 years ago, the trend was set for the future.

Today most large Diesel engines incorporate these leading turbocharger design concepts.

With the new TCA series, MAN B&W have refined the proven technology of the most successful NA series turbochargers.

Advanced material technology provides increased component lifetimes and extended maintenance intervals.

The "integral" TCA design simplifies installation on the engine and maintenance is easier than ever before.

## Worldwide Service

MAN B&W Diesel AG, Stadtbachstr.1, 86224 Augsburg, Germany, Tel +49 821 3220, [www.manbw.de](http://www.manbw.de)  
 MAN B&W Diesel (Singapore) Pte. Ltd., 29 Tuas Avenue 2, Singapore 639460, Tel. +65 897 8112



Circle 258 on Reader Service Card or visit [www.maritimereporterinfo.com](http://www.maritimereporterinfo.com)

# Caterpillar Offers New C12 Engine

Caterpillar recently released a full line of ratings for its new C12 marine diesel engine, the electronically controlled, compact, lightweight 12-liter diesel. With the signature Caterpillar four-stroke, in-line six-cylinder design, the engine is rated 345 mhp (340 bhp, 254 kW) at 1,800 rpm to 710 mhp (700 bhp, 522 kW) at 2,300 rpm. The C12 is aimed at small to mid-sized commercial vessel applications, and is available for worldwide distribution. At its 710 mhp rating, the manufacturer claims that the engine offers the best power-to-weight ratio in its class: 3.65 lb/mhp.

## Something Old ... Something New

The C12 borrows heavily from other engines in the Caterpillar stable, yet features a number of innovations unique to this unit, designed to enhance both performance and durability. For example, a new exhaust manifold design with a special casting at the entrance to the turbocharger reduces backpressure and improves exhaust gas flow, resulting in increased power and lower exhaust temperatures. Piston ring position and cooling oil jet flow to the piston have been fine-tuned to reduce engine temperatures and are designed to improve power output. A new after-cooler core design is to reduce thermal and vibration stress to increase engine durability. In its three highest ratings configurations, the C12 uses the same high-efficiency turbocharger that has proven successful in a twin-turbo

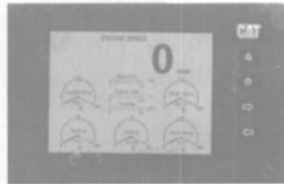

arrangement on the larger Cat 3412E. Electronic control for the engine is provided by Caterpillar's ADEM III electronic control module (ECM). ADEM III has nearly eight times as much memory, nearly twice the input/output capacity and significantly faster processing speed compared to previously available Cat ECMs. The C12s ECM control software is written to maximize power and performance at all commercial ratings, while reducing fuel consumption and meeting all known current and future requirements for NOx emissions. The new engine is also available in keel-cooled configurations to handle the most demanding workboat and fishing boat applications.

Circle 59 on Reader Service Card  
[www.maritimereporterinfo.com](http://www.maritimereporterinfo.com)

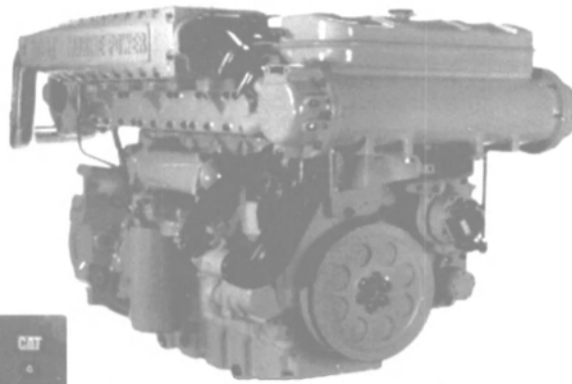

LM2500+ and two by GE LM2500 gas turbines. In addition, GE has a total of eight gas turbine-generators on order for cruise ship applications.

Circle 62 on Reader Service Card  
[www.maritimereporterinfo.com](http://www.maritimereporterinfo.com)

## Integrated Propulsion Controller Launched

Regulateurs Europa now offers an Integrated Propulsion Controller. Designed for any vessel with a diesel engine and a CP propeller, the IPC is installed with the Viking 25 digital electronic governor and engine control system. It is designed to protect against ambient and engine conditions, by monitoring the air and water temperature to run the engine most effectively according to prevailing conditions.

Circle 75 on Reader Service Card  
[www.maritimereporterinfo.com](http://www.maritimereporterinfo.com)

## Siemens, Schottel Extend Pod Cooperation

Siemens Marine and Schottel extended their cooperation on the development and marketing of pod propulsion systems. With this, the product line will be expanded to include systems with outputs less than five MW, making the systems available for smaller vessels, including the offshore market.

Circle 74 on Reader Service Card  
[www.maritimereporterinfo.com](http://www.maritimereporterinfo.com)

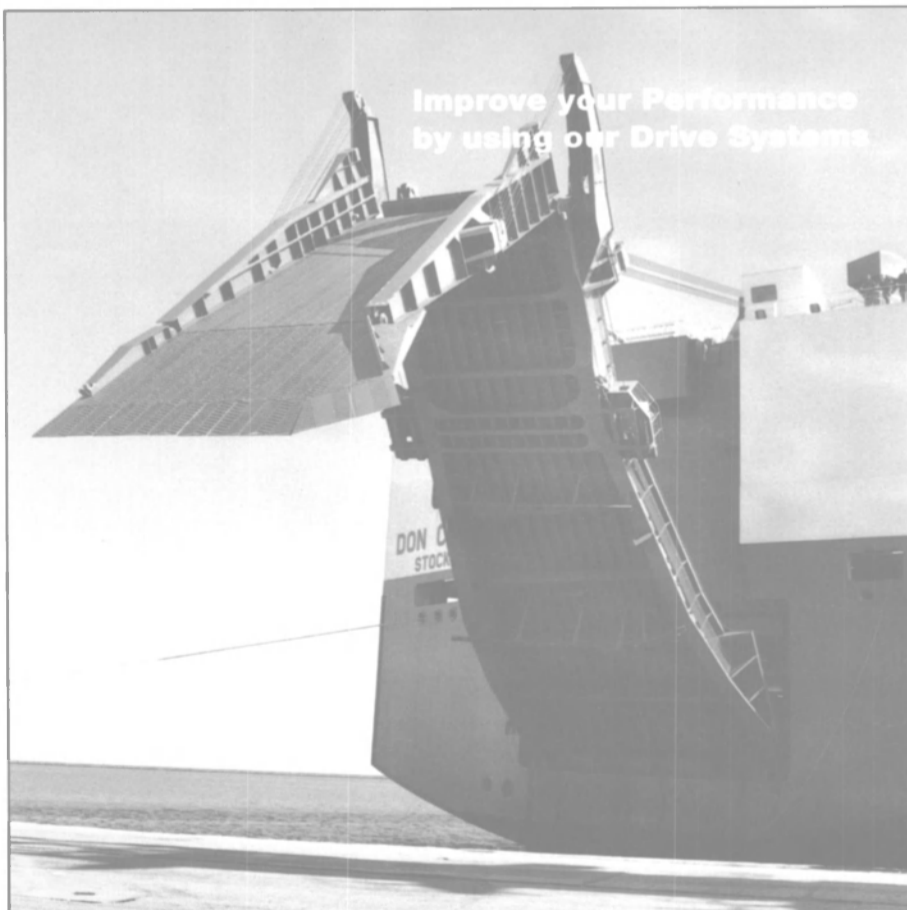

Hagglunds hydraulic direct drives are ideally suited for applications such as propulsion units, cranes and winches; for example RoRo-ramp winches with high demands for precise tension control. Our reliable heavy-duty motors are designed for tough marine environments. In our product program you can find complete drive systems including motors, brakes, valve blocks, power units and controls.

Hagglunds is a world-wide supplier of complete drive solutions. We build our business on reliability in long term relationships and our customised hydraulic drive systems. Our long experience means that we speak the same language as our customers and we have a reputation for high quality products and services.

*A company in the Arcorus Group.*

[www.hagglunds.com](http://www.hagglunds.com)

Hagglunds Drives AB, SE-890 42 Mellansel, Sweden. Tel: +46 660-870 00  
E-mail, Business Area Manager: [ingemar.borg@se.hagglunds.com](mailto:ingemar.borg@se.hagglunds.com)

**Our Drive is your Performance.**



Circle 235 on Reader Service Card or visit [www.maritimereporterinfo.com](http://www.maritimereporterinfo.com)





**ALSTOM**

**91,000 gross tons**

**965 feet long**

**2 pods (27,000 Hp each)**

**Turns on a dime**

**We make amazing things happen**



**ALSTOM Power Conversion, in partnership with Kamewa of Rolls-Royce, has designed the world's largest, most advanced, electric propulsion pod. All four of Celebrity Cruises' new Millennium class cruise ships will be driven by our Mermaid™ azimuth external propellers. So too will the Queen Mary 2. The compact Mermaid™ system releases valuable space inside the hull to accommodate more passengers.**

**Simpler, more flexible operation with higher overall efficiency make Mermaid™ the ideal propulsion solution. This fully integrated system provides excellent maneuverability and crash stop capability and reduces the need for tug assistance. Noise and vibration levels, NOx emissions, maintenance schedules, installation time and costs - all are substantially reduced to provide a safer, greener, more efficient operation.**

**ALSTOM, the global specialist in energy and transport infrastructure**

[www.powerconv.alstom.com](http://www.powerconv.alstom.com)

## Marine Propulsion Annual

(Continued from page 51)

diagnostic equipment worldwide.

These cooling compressors give new meaning to the term "hot swappable" as they are easily stocked and field-replaceable — even when the generator or motor is running — and they occupy the space of a single-drawer file cabinet. HTS motors and generators are designed typically with "n + 1" refrigeration system redundancy to preclude presenting an operational limitation to the ship operator. In addition, the power consumption of these refrigerators is negligible relative to

Fig. 2

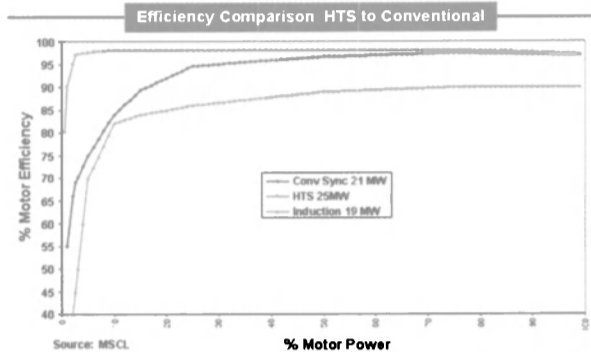

the output of the generator or motor. The reason HTS motors and generators are so efficient is that HTS wire can carry up to 140 times more current than the copper wire of the same size and weight. More current means greater flux density, more powerful magnetic fields and in the case of motors, more torque per unit mass of the machine. HTS motors and generators can therefore be much lighter and smaller, not only because the wire inside them is smaller and lighter, but also because they produce more powerful magnetic fields.

HTS motors also have another advantage: their high

Fig. 3

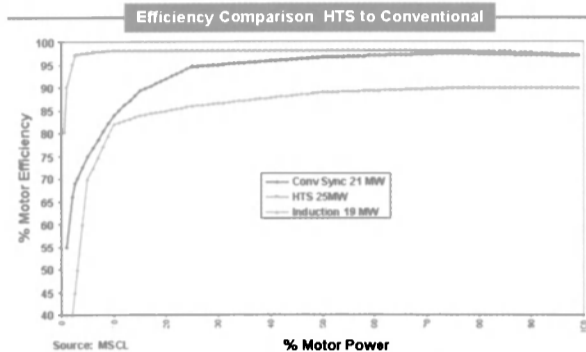

efficiency is a constant across virtually their entire power range. Figure 2 (below, left) compares the calculated efficiency of a typical HTS synchronous marine propulsion motor with equivalent conventional marine propulsion synchronous and induction motors. The calculations also include the losses from the motor cooling system. This means motors and generators can operate at close to maximum efficiency regardless of the ship's speed, creating savings that flow directly to the operators' bottom line. In one study, it was shown that in some scenarios HTS electric propulsion systems

Fig. 4

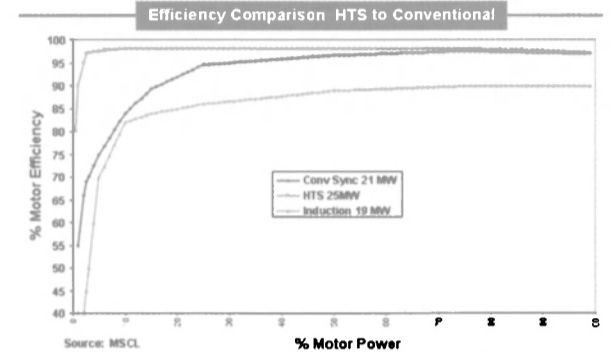

## SCHOTTEL for the Shipping World

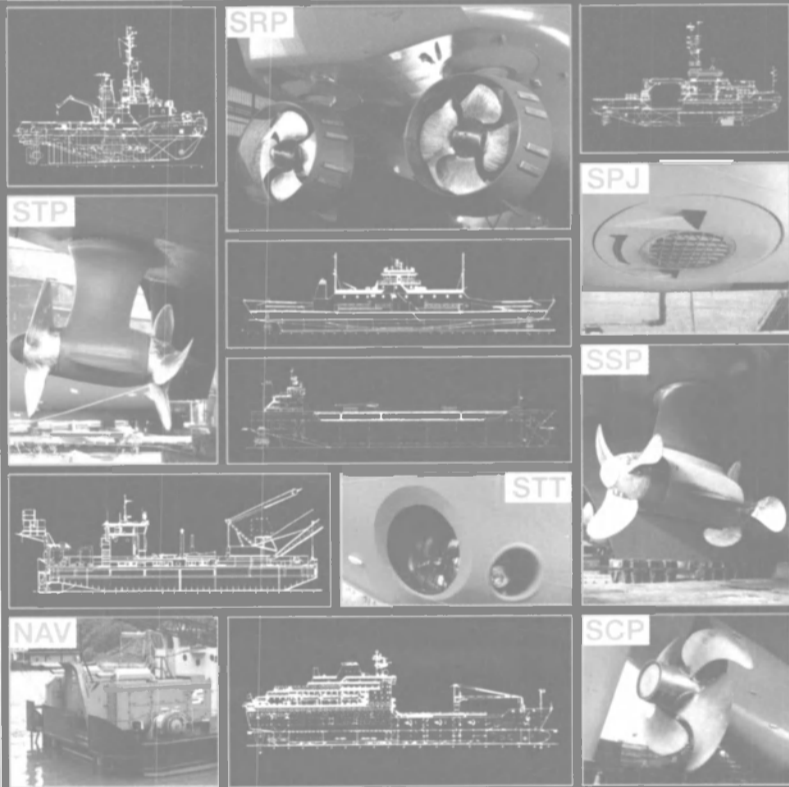

Our product range embraces 360° steerable propulsion systems rated at up to 30 MW, manoeuvring devices, and also complete conventional propulsion packages. Through our worldwide sales and service network we offer economical and reliable solutions for every imaginable maritime application. So we can provide the right thrust for your vessel.

SCHOTTEL, Inc. · 675 Industrial Blvd. · Sugar Land, Tx 77478 · USA  
Tel.: 281-265-3474 · Fax: 281-265-3488 · e-Mail: jschein@schottel.com

Innovators in steerable propulsion

SCHOTTEL GmbH & Co. KG · Mainzer Str. 99 · D-56322 Spay/Germany  
Tel.: + 49 (0) 26 28 / 6 10 · Fax: + 49 (0) 26 28 / 6 13 00 · e-Mail: info@schottel.de · www.schottel.de

Circle 286 on Reader Service Card  
or visit [www.maritimereporterinfo.com](http://www.maritimereporterinfo.com)

## STORK®

Stork Bronswerk  
Nuclear Biological and  
Chemical Filtration Units (NBC)  
Naval Chilled Water Plants

**Our expertise:**

- NBC Filtration
- Chilled Water Plants  
(Shock and Vibration Qualified)
- Radar Cooling Units

**Our Clients:**

- NATO Navies

**Your Benefits:**

- Expert technical solutions
- Modularized systems and subsystems
- Integrated logistic support
- Life cycle support
- Experienced Designer, Supplier and Installer of "Turnkey" HVAC Systems

**Stork Bronswerk Inc.**

3755C boul. Matte (450) 659-6571  
Brossard, Quebec (450) 659-1035  
J4Y 2P4 Canada [stork@stork-mtl.com](mailto:stork@stork-mtl.com)

**U.S. Offices**

2468 Dauphine Street Suite A New Orleans, LA 70117 (504) 943-6284 (504) 943-0268 [ebstork@i-55.com](mailto:ebstork@i-55.com)  
701 NW. Madrona Way Coupeville, WA 98239-9798 (360) 678-3720 (360) 678-2253 [storkwestcoast@att.net](mailto:storkwestcoast@att.net)

**Stork Bronswerk B.V.**

Uraniumweg 23, P.O. Box 494 3800 AL Amersfoort The Netherlands 31 33 467 8300 31 33 463 7161 [info.bronswerk@stork.com](mailto:info.bronswerk@stork.com)

1-800-465-7749

[www.stork.com/bronswerk](http://www.stork.com/bronswerk)

We control the elements

Circle 295 on Reader Service Card  
or visit [www.maritimereporterinfo.com](http://www.maritimereporterinfo.com)

can achieve fuel and lube oil cost parity with diesel direct drive ships.

**Size/Weight/Power Comparisons**

The implications of these advantages for shipbuilders are far-reaching — especially since they apply to both the generator and the motor. Compare, for example, the weight and size of a variety of HTS and conventional synchronous motors ranging in power ranges from 5 to 90 MW, and at slow speeds as required for marine propulsion. All are 4.2 KV machines. Figure 3 (previous page) shows a weight versus power comparison for the two technologies. Figure 4 shows a size versus power comparison. The size comparisons also include maintenance volume, allowing one meter all around the HTS motor (except the bottom) and two meters all around the much larger conventional motor (again, except the bottom).

The weight savings advantage achieved by HTS motors is particularly valuable in pod applications. It has been estimated that for every 500 tons less light ship weight, about 40 more containers can be carried. Thus, a container ship using HTS podded propulsors will be able to carry about 2.5 to 4 percent more containers.

Complementing their light-weight and compact size, HTS motors can be optimized around specific dimensional requirements. These requirements may include minimizing a propulsion motor's diameter to maximize the hydrodynamic performance of a propulsion pod or to create increased cargo capacities in ships/ lower decks, or maximizing the machine's efficiency. The machines' reduced size creates volume and deck savings that are advantageous in virtually all types of ships, both military and commercial.

Likewise, HTS generators will be much smaller and lighter than their conventional counterparts. In fact, HTS generators enjoy an additional advantage: they operate with greater efficiency than their conventional counterparts even when the refrigeration requirements are considered.

With such small motors and generators, ship machinery space allocations become much less restrictive — making room for more revenue producing volume and allowing for highly innovative designs. Consider for example a 25 MW HTS generator. Coupled with a marine gas turbine engine at about 17 tons, the overall unit could weigh less than 50 tons. This might be light enough in some ships to mount the system in the deckhouse, offering much more revenue space below, better turbine efficiency, and better maintenance access which may, in some instances, offset the drawbacks of environmentally friendly but relative inefficient gas turbines. Such small and light HTS elec-

tric motors might, for example, enable more efficient electric drive pump-jet systems and hydrodynamically optimized pod drives that offer better efficiency and higher power than is achievable with conventional motors.

As noted earlier, HTS propulsion systems have the additional advantage of being able to operate just as efficiently down to low speeds, which is especially

important for cruise ships, coastal merchant ships and warships that spend much of their time operating at partial loads. Overall, the fuel savings from efficiency gains of HTS machines depend on the operating scenario but preliminary calculations suggest that fuel savings from \$100,000 to \$500,000 per ship per year can be expected for many ship types.

**Other Advantages**

There are other advantages of HTS machinery as well. Because there is little or no iron in the magnetic path of the motor or generator, there is very little distortion in the power supply and little noise feedback from the motor. This should simplify power-conditioning system requirements and make for extraor-

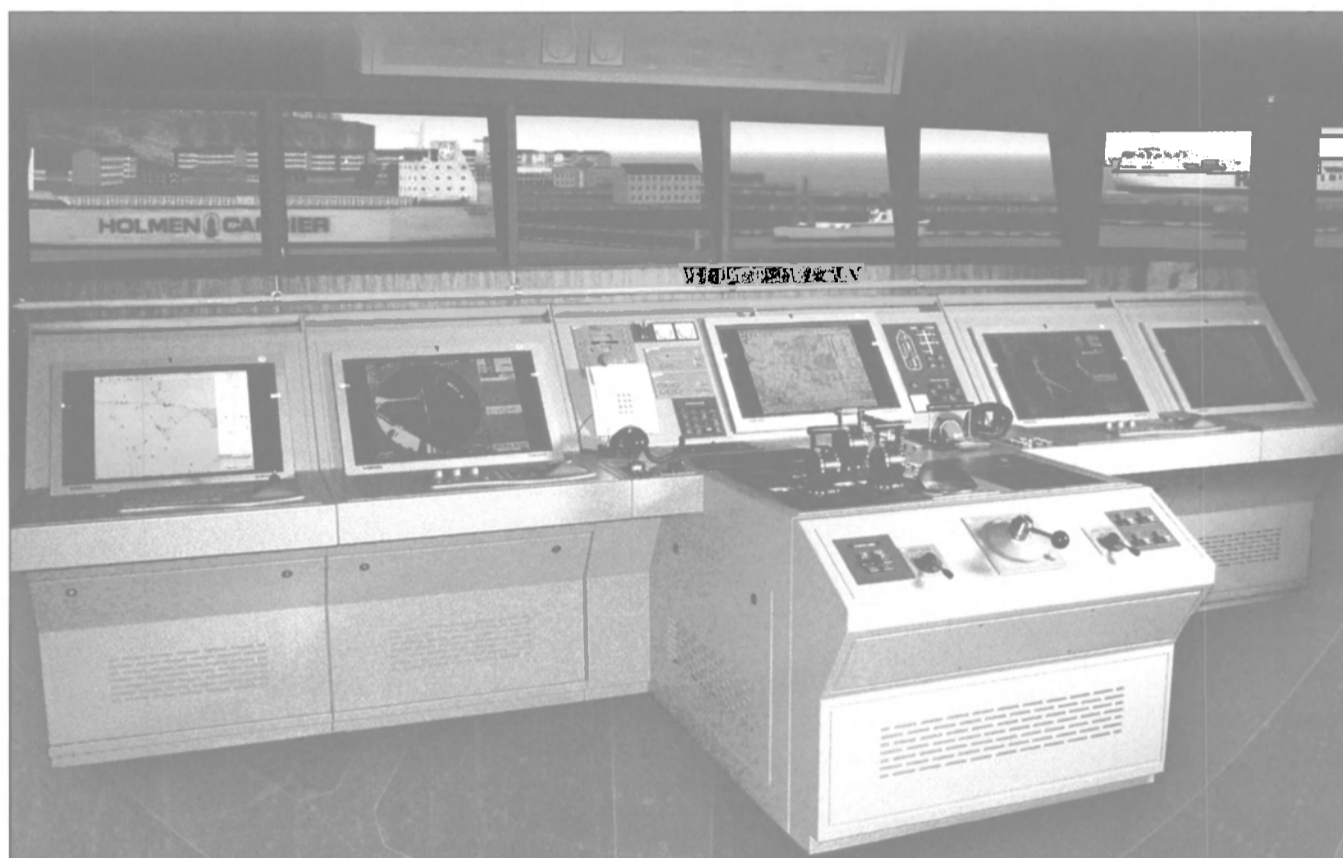

**The Art of Simulation Has Reached a New State**

Introducing the stunningly realistic STN Atlas ANS 5000 360° full mission bridge simulator.

MITAGS' new full-mission simulator employs the latest generation of photo-textured on-screen graphics, advanced ship maneuvering capabilities and a complete Raytheon™ integrated bridge system utilizing Kamewa™ joystick control systems for steering and ship maneuverability. Through the use of STN Atlas designed removable bridge equipment sections, the MITAGS Raytheon Integrated Bridge System (IBS) is configurable and adaptable to many different types of shiphandling and bridge resource training.



**Maritime Institute of Technology & Graduate Studies (MITAGS)**  
Pacific Maritime Institute (PMI)

MITAGS

Call: 443 989 3235  
e-mail: admissions@mitags.org  
5700 Hammonds Ferry Road  
Linthicum Heights, Maryland 21090  
www.mitags.org

PMI

Call: 206 441 2880  
e-mail: info@stcw95.com  
2333 Third Avenue  
Seattle, WA 98121-1711  
www.stcw95.com

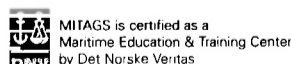

MITAGS is certified as a Maritime Education & Training Center by Det Norske Veritas

- MITAGS the leader in STCW-95 training offers 29 USCG approved courses including:
- Electronic Navigation ■ Chiefmate/Master Upgrade ■ Fast Rescue Boat ■ Bridge Resource Management & Shiphandling
  - Medical Person in Charge ■ Basic Safety Training ■ Basic & Advanced Firefighting ■ Tankerman Person in Charge (PIC)
  - Crowd and Crisis Management ■ Heavy Weather Avoidance ■ Global Maritime Distress & Safety Systems

Circle 264 on Reader Service Card or visit [www.maritimereporterinfo.com](http://www.maritimereporterinfo.com)

## Marine Propulsion Annual

dinarily quiet machinery (both electrically and acoustically). The lower weight of the generator rotor also reduces noise.

In other respects, HTS machines behave like conventional electric machines. Their magnetic field can be dumped quickly in case of a system casualty, just like in a conventional synchronous motor or generator. They can be operated with existing synchroconverters, cycloconverters or PWM converters, although some simplification of these systems may be possible in order to take advantage of the lower distortion.

The machines' low weight and small size allow them to be shipped and installed intact, rather than having to be built and tested at the factory, disassembled for shipment to the shipbuilder, and then reassembled and tested at the building yard prior to installation.

Preliminary pricing evaluations indicate that HTS motors and generators should be commercially available at

prices equivalent to conventional machines but be easier and less expensive to install — and could be installed later in the ship's construction.

### The View Forward

So what's next for HTS and how soon will it be widely deployed? HTS wire has been extensively tested in Navy and commercial laboratories, and its durability has been proven. HTS motors rated up to 5,000 hp at 1,800 rpm have been built and tested successfully to a continuous rating of 5,900 hp.

A 230-rpm, 5 MW ship propulsion prototype motor, funded by the U.S. Navy's Office of Naval Research, is now being built at American Superconductor Corporation, and will be rigorously evaluated by the U.S. Navy in the last half of 2003. A 100 MVA HTS commercial generator, funded in part by the U.S. Department of Energy, is under development at General Electric. From this view, it appears that HTS-based propul-

sion systems are the next generational improvement in marine propulsion systems. Naval architects can now begin to translate these propulsion system improvements into increased profitability for ship owners and operators.

Circle 78 on Reader Service Card  
www.maritimereporterinfo.com

### About the Author

Stuart C. Karon is Director, Government Programs and Director, Business Development for the Electric Motors and Generators Business Unit at American Superconductor. Formerly a U.S. Navy Officer and subsequently marketing & sales director in the commercial sector, Karon is responsible for structuring effective government-funded R&D and system design/development programs, and for bringing about the business relationships necessary for the American Superconductor Corporation Electric Motors and Generators Business Unit to achieve its objectives. He can be reached at Skaron@Amsuper.Com.

## MAN B&W Two-Stroke Engines Enter Vietnamese Market

In August 2002, two 7535MC engines were delivered to Vietnam from MAN B&W Diesel A/S in Frederikshavn, Denmark - builders of the engines. The engines, which will be installed in two 11,500-dwt freighters ordered by Vinashin Shipping and Service Company from the Bach Dang and Ha Long Shipyards, have an output of 5,180 kW at 173 rpm. The 35MC was the first engine in the MC-engine program when it was introduced two decades ago and has proved a huge success with more than 1,000 engines ordered or delivered. In total there are 6,885 MC engines on order or delivered as per July 2002.

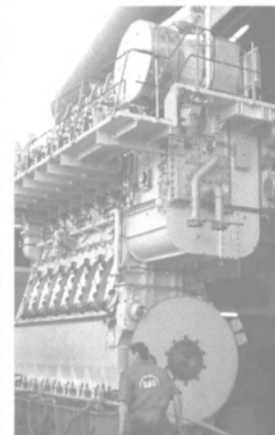

Circle 11 on Reader Service Card  
www.maritimereporterinfo.com

\* See Spurs Demo!! SMM Show Hamburg  
September 24-28 American Pavilion

## SPURS PROTECTS YOUR FLEET.

From net and line entanglements and resulting oil seal damage



### The Cutting Edge Propeller Entanglement Solution

Spurs Cutter Systems are the world's most efficient and cost effective method of eliminating propeller entanglement and are trusted by U.S. Navy and commercial fleets worldwide. Spurs instantly cut lines and nets and prevent unscheduled dry-docking due to aft seal damage.

Awesome cutting ability shown after completion of cutter installation.

### Environmental Challenge

#### Don't take a chance!!

Avoid expensive fines and downtime from resulting oil leakage due to line and net intrusion into aft oil seals. (as shown here)

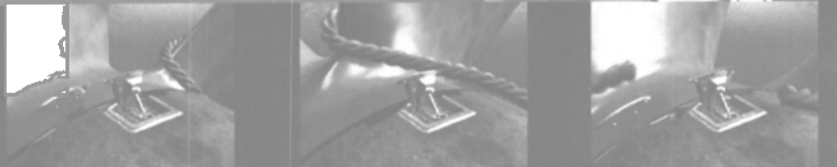
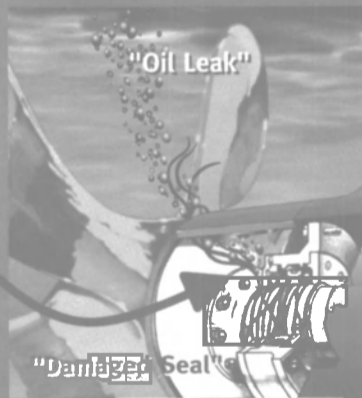

All size Spurs cutters are in stock ready for immediate shipment and installation at your next dry docking.



For more information, or to request a free cd-rom, visit us at: [www.spursmarine.com](http://www.spursmarine.com)  
email: [spurs@spursmarine.com](mailto:spurs@spursmarine.com) Phone (954) 463-2707 Fax (954) 525-0239  
Spurs Marine 201 SW 33rd Street Ft. Lauderdale, FL 33315

Circle 294 on Reader Service Card or visit [www.maritimereporterinfo.com](http://www.maritimereporterinfo.com)

# Water-Cooled AC Drive?

## What else, from the company that's Ahead of the Curve?

Oilfield-Electric-Marine does AC drives like nobody's business — because no other company's business is as much about AC drives as ours is.

It's why we stay ahead of the curve with a water-cooled system that produces 1,150 horsepower in a footprint just 14 inches wide — at a weight-saving commensurate with the space it saves.

We offer air-cooled units as well, and advanced AC motors to 1,500 hp. Or if DC's your preferred power source, you'll find our SCR drives and controllers equally ahead of the curve.



Ahead of the Curve

3616 Pinemont / Houston, Texas 77018 / 713-680-9159 / [www.oilfieldelectricmarine.com](http://www.oilfieldelectricmarine.com)

Circle 318 on Reader Service Card or visit [www.maritimereporterinfo.com](http://www.maritimereporterinfo.com)

Maritime Reporter & Engineering News



*The*  
**Ship Power**  
Supplier

Wärtsilä delivers solutions of all shapes and sizes – from single components to fully compatible ship machinery, propulsion and manoeuvring solutions tailored to

suit your ship's specific design and its operational requirements. Lifetime support included and added value guaranteed. For all your needs, Wärtsilä is the one.

- Main and auxiliary engines • Generating sets • Reduction gears • CP propellers • FP propellers • CIPS
- Steerable thrusters • Waterjets • Transverse thrusters • Control systems • Rudders • Seals • Bearings • Design
- Engineering • Project management • Commissioning • Financing • Technical support and maintenance
- For more information visit [www.wartsila.com](http://www.wartsila.com) • Wärtsilä is a registered trademark

Circle 310 on Reader Service Card or visit [www.maritimereporterinfo.com](http://www.maritimereporterinfo.com)



**WÄRTSILÄ**

# Stern Tube Lubricant Absorbs Costs

In many industries and businesses, equipment failure or unexpected maintenance does not present a major problem. Standby systems can be brought online quickly, service engineers can repair machinery within a few hours, with spare parts that are readily available, or temporary equipment can be hired at a moment's notice.

For some industries, however, failure or serious malfunction of machinery can be very damaging, whether financially or commercially. Such industries include steel making, oil and gas processing, underground mining, and shipping.

Some systems aboard ships do not have standby

backups, spare parts may be difficult or impossible to replace while at sea, even if they are carried on the vessel, and delays to voyages (whether through stoppage or slowdown) are likely to be costly. One item of equipment on ships that is not possible to replace or repair while at sea is a stern-tube bearing.

Benjn. R. Vickers & Sons Ltd., based in Leeds, England, offers the Hydrox range of specialized stern-tube oils. Hydrox stern-tube oils absorb water, which may enter the stern-tube bearing, and the resulting emulsions continue to provide a high standard of lubrication and corrosion protection to the shaft and bearings. All of the oils in the Hydrox range are approved under the Lloyds Product Verification scheme. They are the first lubricants to have been approved in this way, with benefits of the Hydrox oils acknowledged by other leading Classification Societies.

Oil lubricated bearings are more than likely white metal, but can be manufactured from specialized resin material. In either case the stern-tube is filled with oil, which is retained by means of a seal system designed not only to keep the oil in, but also to prevent seawater from entering. A header tank for the oil maintains a static head of pressure, which supports the sealing system in discouraging water entry.

Stern-tube bearings can operate satisfactorily — with few or no problems. Sometimes, however, the stern

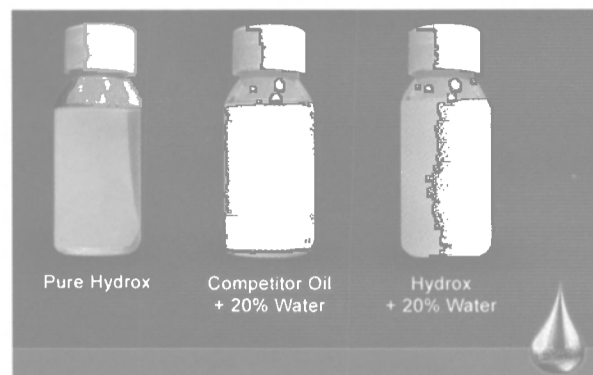

tube seals can become worn or damaged. Equally, conditions can arise whereby seawater bypasses the seal. For example, the oil/sea-water pressure relationship can be radically affected if extreme pitching is experienced, or stern tube vibration can result in seawater being drawn in and/or oil being forced out. It is not at all uncommon for oil to leak out of the stern-tube, creating a pollution problem, or more often for seawater to leak in or indeed both — water can do enormous damage to plain bearings. Where a conventional oil is being used, the presence of water can cause rusting and corrosion, and it can seriously compromise the quality of lubrication offered to the bearings. Any of these factors is likely to lead eventually to bearing damage and failure. Obviously, a stern-tube should be fitted with high performance seals, but a specialist stern-tube lubricant, which is able to lubricate bearings even in the presence of significant quantities of seawater, can provide very real cost savings. The Hydrox range of stern-tube oils manufactured by Vickers are specific-

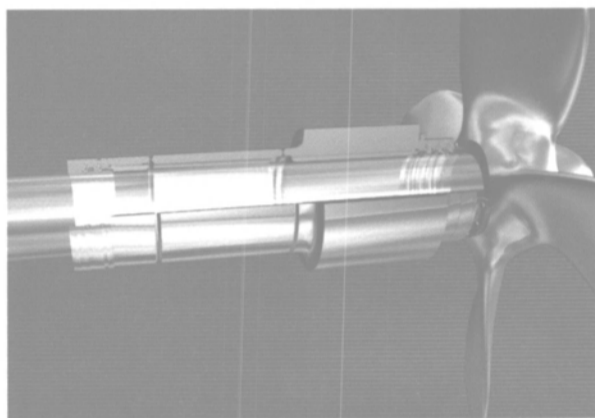

**“We’re No.1. The Best.”**

MMC manufactures the world's best selling portable gauging and sampling equipment for petroleum and chemical service. That says it all. For ullage, temperature and interface sensing, MMC makes it easy, accurate and user friendly.

**See us at SNAME, Booth 47**

**MMC International Corp.**

Inwood, New York USA • 1-800-645-7339

Fax: 516-371-3134 • Web: [www.mmciintl.com](http://www.mmciintl.com) • E-mail: [mmcinwd@aol.com](mailto:mmcinwd@aol.com)  
MMC (Europe) Ltd. • Fax: (01670) 738789 • E-mail: [mmceurope@email.msn.com](mailto:mmceurope@email.msn.com)  
MMC (Asia) Ltd. • Fax: (078) 252-0265 • E-mail: [mmc.asia@zvcity.com](mailto:mmc.asia@zvcity.com)

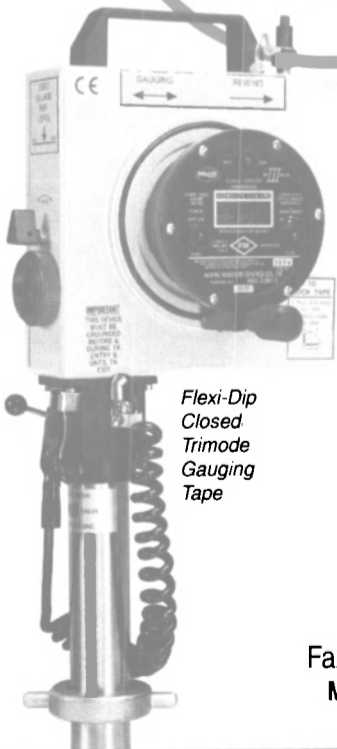

Flexi-Dip  
Closed  
Trimode  
Gauging  
Tape



Circle 265 on Reader Service Card or visit [www.maritimereporterinfo.com](http://www.maritimereporterinfo.com)



*The*  
**Ship Power**  
Supplier

Wartsila delivers solutions of all shapes and sizes – from single components to fully compatible ship machinery, propulsion and manoeuvring solutions tailored to

suit your ship's specific design and its operational requirements. Lifetime support included and added value guaranteed. For all your needs, Wartsila is the one.

- Main and auxiliary engines • Generating sets • Reduction gears • CP propellers • FP propellers • CIPS
- Steerable thrusters • Waterjets • Transverse thrusters • Control systems • Rudders • Seals • Bearings • Design
- Engineering • Project management • Commissioning • Financing • Technical support and maintenance
- For more information visit [www.wartsila.com](http://www.wartsila.com) • Wärtsilä is a registered trademark

Circle 310 on Reader Service Card or visit [www.maritimereporterinfo.com](http://www.maritimereporterinfo.com)



**WÄRTSILÄ**

# Stern Tube Lubricant Absorbs Costs

In many industries and businesses, equipment failure or unexpected maintenance does not present a major problem. Standby systems can be brought online quickly, service engineers can repair machinery within a few hours, with spare parts that are readily available, or temporary equipment can be hired at a moment's notice.

For some industries, however, failure or serious malfunction of machinery can be very damaging, whether financially or commercially. Such industries include steel making, oil and gas processing, underground mining, and shipping.

Some systems aboard ships do not have standby



backups, spare parts may be difficult or impossible to replace while at sea, even if they are carried on the vessel, and delays to voyages (whether through stoppage or slowdown) are likely to be costly. One item of equipment on ships that is not possible to replace or repair while at sea is a stern-tube bearing.

Benjn. R. Vickers & Sons Ltd., based in Leeds, England, offers the Hydrox range of specialized stern-tube oils. Hydrox stern-tube oils absorb water, which may enter the stern-tube bearing, and the resulting emulsions continue to provide a high standard of lubrication and corrosion protection to the shaft and bearings. All of the oils in the Hydrox range are approved under the Lloyds Product Verification scheme. They are the first lubricants to have been approved in this way, with benefits of the Hydrox oils acknowledged by other leading Classification Societies.

Oil lubricated bearings are more than likely white metal, but can be manufactured from specialized resin material. In either case the stern-tube is filled with oil, which is retained by means of a seal system designed not only to keep the oil in, but also to prevent seawater from entering. A header tank for the oil maintains a static head of pressure, which supports the sealing system in discouraging water entry.

Stern-tube bearings can operate satisfactorily — with few or no problems. Sometimes, however, the stern

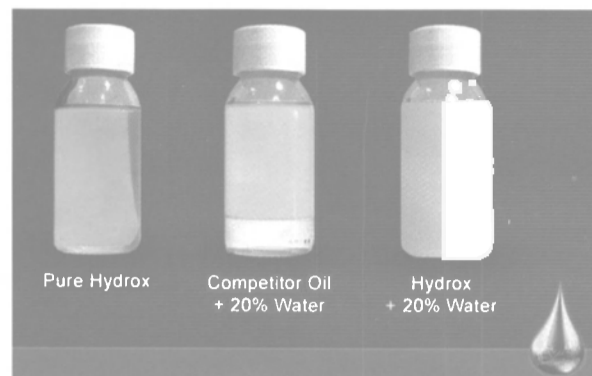

tube seals can become worn or damaged. Equally, conditions can arise whereby seawater bypasses the seal. For example, the oil/sea-water pressure relationship can be radically affected if extreme pitching is experienced, or stern tube vibration can result in seawater being drawn in and/or oil being forced out. It is not at all uncommon for oil to leak out of the stern-tube, creating a pollution problem, or more often for seawater to leak in or indeed both — water can do enormous damage to plain bearings. Where a conventional oil is being used, the presence of water can cause rusting and corrosion, and it can seriously compromise the quality of lubrication offered to the bearings. Any of these factors is likely to lead eventually to bearing damage and failure. Obviously, a stern-tube should be fitted with high performance seals, but a specialist stern-tube lubricant, which is able to lubricate bearings even in the presence of significant quantities of seawater, can provide very real cost savings. The Hydrox range of stern-tube oils manufactured by Vickers are special-



TM

**“We’re No.1. The Best.”**

MMC manufactures the world's best selling portable gauging and sampling equipment for petroleum and chemical service. That says it all. For ullage, temperature and interface sensing, MMC makes it easy, accurate and user friendly.

**See us at SNAME, Booth 47**

**MMC International Corp.**

Inwood, New York USA • 1-800-645-7339

Fax: 516-371-3134 • Web: [www.mmcintl.com](http://www.mmcintl.com) • E-mail: [mmcinwd@aol.com](mailto:mmcinwd@aol.com)

MMC (Europe) Ltd. • Fax: (01670) 738789 • E-mail: [mmceurope@email.msn.com](mailto:mmceurope@email.msn.com)

MMC (Asia) Ltd. • Fax: (078) 252-0265 • E-mail: [mmc.asia@zvcity.com](mailto:mmc.asia@zvcity.com)

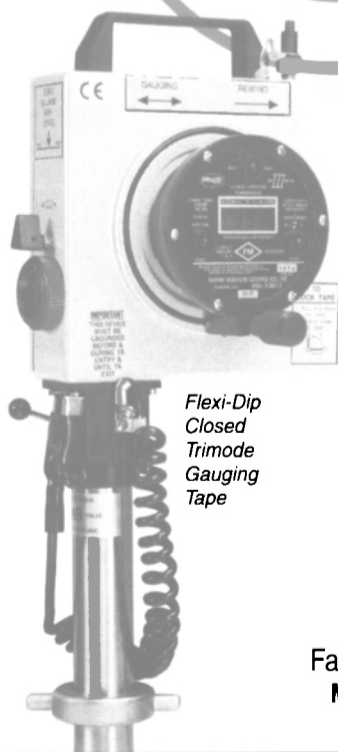

Flexi-Dip  
Closed  
Trimode  
Gauging  
Tape



Circle 265 on Reader Service Card or visit [www.maritimereporterinfo.com](http://www.maritimereporterinfo.com)



ly formulated to do just that.

Conventional engine oils that are often used to lubricate stern-tubes do not form stable emulsions with water, particularly seawater. Some "emulsifiable oils" may form emulsions, which are unstable, thereby allowing free water, leading to a breakdown in lubrication.

Water ingress into a stern-tube lubricated with a conventional oil or unsuitable "emulsifiable oil" may therefore lead to serious bearing failure and damage to the propeller shaft should there be any significant degree of contamination with seawater. Hydrox 550 has been developed especially for use in stern-tubes. It forms stable emulsions with water and these continue to provide a high standard of lubrication and corrosion protection. Consequently, unscheduled repairs are unnecessary.

Vickers calculates, for example, that an offshore supply vessel could achieve net savings of more than \$21,538 where Hydrox 550 is in use and there is significant water entry into the system. These savings arise largely from the avoidance of unscheduled docking. Similarly, a large crude oil tanker could save more than \$215,385 on a similar basis. The significance of the unit price premium is further diminished when the modest volumes of oil used in the stern-tube are taken into account.

For example, Hydrox 550 is currently being used on the Queen Elizabeth 2 (QE2), the Oriana and the Ocean Princess. It is also being used on Stolt-Nielsen ships and on Andros Maritime ships. **Chris Zukowski**, Atlantic Fleet Manager at Stolt-Nielsen Transportation Group, says, "Stolt-Nielsen vessels use Hydrox 550 as a stern-tube lubricant because experience has shown that seawater entry into the stern-tube can occur on occasions. Using Hydrox 550 greatly reduces the likelihood of interrupted sailing schedules due to emergency repairs." **G. Foustanos**, superintendent

engineer at Andros Maritime adds, "Andros Maritime, the tanker fleet agent, is typical of the growing number of Hydrox 550 users who value the long-term benefits provided by the product."

Hydrox 550 has been formulated so that it will form stable emulsions with up to 20 percent of seawater, which may enter the stern-tube. The oil is suitable

for use in stern-tube systems fitted with circulatory oil-feed systems and is approved by leading seal manufacturers having been tested for compatibility with their seal materials. It may well be the case that a conventional oil is not compatible with the seal in which case excessive swelling or embrittlement of the seal can occur with consequent seal

failure. Hydrox 550 is also used in cruise liner stabilisers, again to combat water ingress into the lubrication system. The oil is approved by a number of stabiliser manufacturers, including Sperry Marine and Brown Brothers.

Circle 40 on Reader Service Card  
www.maritimereporterinfo.com

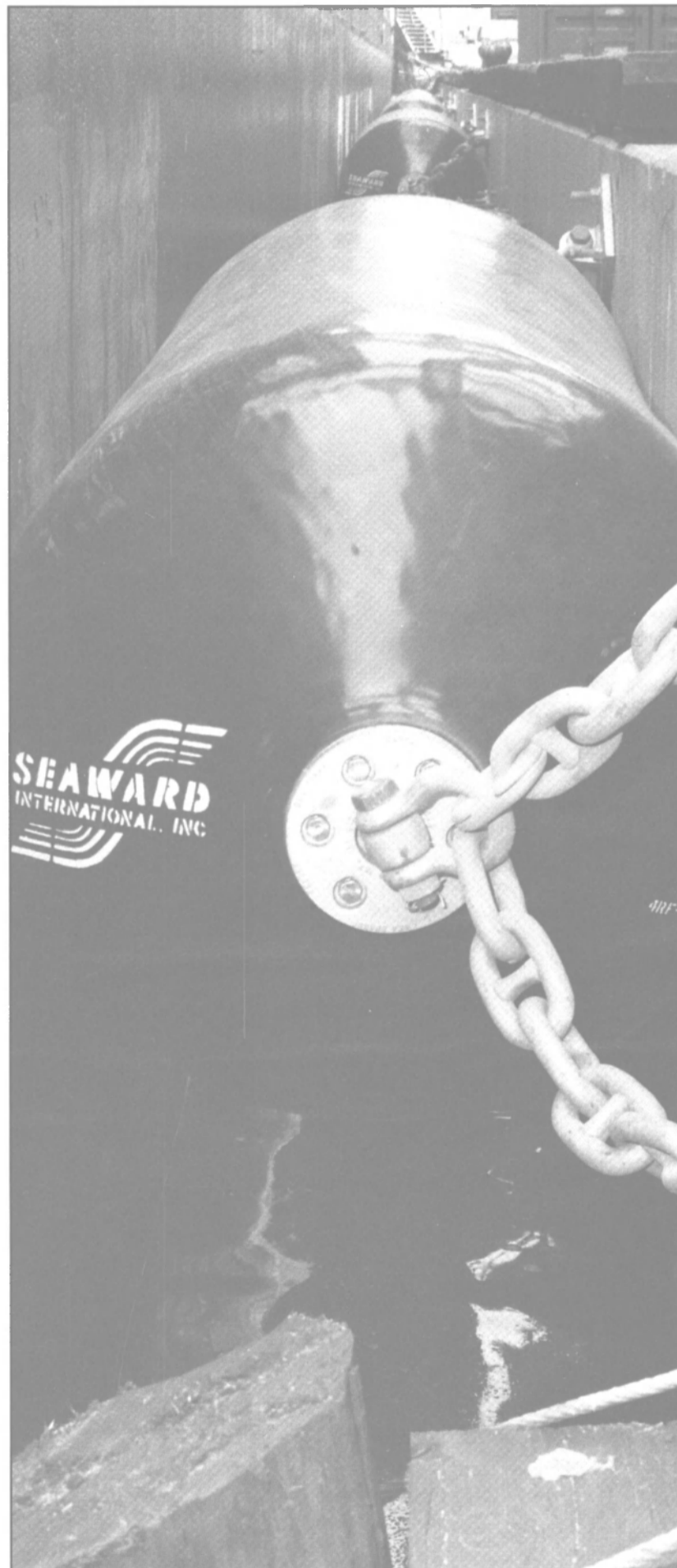

**You'd Be  
Hard-  
Pressed  
To Find  
A Better  
Fender.  
Really  
Hard-  
Pressed.**

Large or small, floating or fixed, Seaward SEA GUARD® fenders cover you from the tropics to the arctic. Seaward International brings to fender technology the same rigorous quality control and attention to detail we put into all our marine products. From the 2'x4' to the tanker-scaled 12'x24', all our fenders meet the most stringent quality and performance standards.

The SEA GUARD fender combines quality assurance standards with new elastomer technologies such as a reinforced skin, making it the answer to most fender system requirements.

The first of its kind 20 years ago, the Seaward foam-filled fender maintains its record of reliability. And we continue to develop and supply the protective marine technologies that keep you on course.

All our products tell the same story: Seaward is committed to safeguarding your peace of mind.

Structures, ships, environments, budgets: We protect it all.



3470 Martinsburg Pike, P.O. Box 98,  
Clearbrook, VA 22624-0098 USA  
1-800-828-5360 • 540-667-5191  
Fax: 540-667-7987 www.seaward.com

SEA GUARD® is a registered trademark of the Chem Ray-SEAGUARD Corporation. Used under license by SEAWARD International, Inc.

## Wärtsilä, Haldor Topsøe To Cooperate on Fuel Cell Development

Wärtsilä entered into an agreement with Haldor Topsøe A/S to start a joint development program within the area of fuel cell technology, aiming to bring to the market highly efficient, clean and cost competitive fuel cell products with power outputs above 200 kW for distributed power generation and marine applications. Wärtsilä will apply its know-how in decentralized power plant applications and marine propulsion systems. Haldor Topsøe has long experience in catalyst development for oil industry and in development of planar solid oxide fuel cell (SOFC) technology. The program is part of Wärtsilä's strategy to provide environmentally friendly solutions for customers with various power generation needs. SOFC technology will provide products for cogeneration applications with ultra-low emission levels, high efficiency and outstanding reliability.

Circle 61 on Reader Service Card  
www.maritimereporterinfo.com

Circle 289 on Reader Service Card or visit www.maritimereporterinfo.com

# The New Hunter/Gatherers

In its search for sea mines, the Remote Minehunting Vehicle (RMV) tows a variable depth sensor (VDS) containing four sonars. The combined sonar coverage enables the VDS to detect bottom, close-tethered and moored mines along its search track. The RMV also features a forward-looking sonar by which to detect and avoid moored mines. The RMV sends back contact data to the host ship via radio link from atop its mast.

(All photos are permission of Lockheed Martin Naval Electronics & Surveillance Systems)

## *U.S. Navy's Unmanned Mine Reconnaissance System Will Provide Organic Mine Countermeasures Capability*

By Frans Jurgens, freelance defense writer

The concept that a naval task force operating in littoral waters can detect underwater mines using remotely controlled unmanned vehicles is on the verge of being realized.

In Syracuse, N.Y., where Lockheed Martin Naval Electronics & Surveillance Systems (NE&SS) division has been developing just such a mine reconnaissance system for the USN, confidence is high that requirements have been met or exceeded.

In Pascagoula, Miss., Ingalls Shipbuilding is constructing USS Pinckney, the first of 11 Arleigh-Burke class guided missile destroyers (DDGs) whose mission will include this mine countermeasures (MCM) capability. By late 2003, the new ship will take delivery of a mine reconnaissance system that will change the way the USN thinks about and conducts what it calls "organic" or "assigned" (i.e. on-board) mine warfare.

The system to be carried by each Flight IIA DDG is designated AN/WLD-1(V)1. Its principal component is a 23-ft. (7m) semi-submersible, semi-autonomous

Remote Minehunting Vehicle (RMV) that tows an advanced variable depth sensor (VDS) whose purpose is to detect, classify, localize and identify moored and bottom mines. The RMV can operate over the horizon from its host ship, sending back mine contact data and obstacle avoidance video imagery via radio link.

But WLD-1 is not an isolated phenomenon. It is one of seven organic MCM (OMCM) programs currently under development for the USN. By 2005, these permanently assigned OMCM capabilities will begin extending the combat systems reach of carrier battle groups — and later, potentially, amphibious ready groups. These systems will integrate with the sensors and weapons of ships, helicopters and submarines to enable minefield reconnaissance, minehunting, minesweeping and, if necessary, clearance of the mine threat to enable a limited breakthrough ability.

The effect of the organic MCM approach is to mainstream mine warfare in the U.S. Navy from a domain for specialists to a basic skill for all naval warfighters.

### **The Case for Organic**

On the morning of February 18, 1991, in the northern Persian Gulf, the amphibious assault ship USS Tripoli struck a Pattern 1908 contact mine. The explosion ripped a 20 x 30-ft. hole in the ship's hull on her starboard bow and injured four sailors.

Hours later, the USS Princeton, a guided missile cruiser, detonated an Italian-made MRP acoustic mine lying on the seabed. The gas bubble from the explosion spread underneath the ship's keel transferring large volumes of energy into the structure. While not holed, 80 percent of the structural strength of the ship was compromised.

Since the beginning of the Cold War, at least 12 other Navy ships also have been casualties of mines, most during the Korean conflict. The worst mine incident occurred in 1988 during the Gulf Tanker War when the frigate Samuel B. Roberts nearly sank after striking an Iranian SADAF-02 contact mine. Although the mine cost just \$1,500, the explosion caused nearly \$96 million in damages.

Since 1950, the Navy has spent hundreds of millions of dollars to repair ship damage caused by mines each costing only a few thousand dollars. Furthermore, most of the affected ships were out of action for months. Countering asymmetric warfare of this kind would require transformational thinking, strategies and assets.

Already by 1991, changes in world geopolitics were shifting the focus of operations of the Navy forward-deployed forces from the open ocean to the littorals where mines are prevalent. Littoral waters, by definition, range from the shoreline out to water depths of

# L-3 Communications Acquires Ross Engineering



Hardened Voyage Recorder



Universal Automatic Identification Systems



Digital Selective Calling Radios



L-3 Communications welcomes Ross Engineering, the leader and revolutionary provider of DSC and AIS technologies, to our Aviation and Maritime products family. The agreement brings Ross' 20 years at the forefront of maritime port control together with L-3's solid leadership and management backbone. Learn more about what L-3 can do for you at [www.L-3Com.com](http://www.L-3Com.com) and you'll know why we say "Call L-3 First." For more information please call L-3 Communications Aviation Recorders at (941) 371-0811.

Circle 332 on Reader Service Card or visit [www.maritimereporterinfo.com](http://www.maritimereporterinfo.com)

CALL



communications

FIRST

## Sea Technology



The 13,000-lb RMV is launched using a davit that extends just beyond the ship's hull and lowers the vehicle into the water. Retrieval is the same procedure in reverse. At pre-programmed GPS coordinates, or on command from the host ship, the RMV can deploy and retrieve its variable depth sonar (shown as the white attachment with red fins under the RMV). The RMV is the principal component of the AN/WLD-1(V)1 Remote Minehunting System - to be deployed on U.S. Navy Arleigh-Burke class destroyers in 2005.

*(All photos are permission of Lockheed Martin Naval Electronics & Surveillance Systems)*

600 ft. At issue is the need by carrier and amphibious groups to dominate the littoral space, whether to project power or protect maritime shipping. Unrestricted access to, and maneuverability within, a littoral region's narrow and constricted geographic area are crucial if Navy and allied forces are to prevail.

Mines therefore cannot become showstoppers. In addition to executing other missions, ships captains and fleet commanders need to gain quickly the knowledge of the mine threat without having to wait for the arrival of dedicated MCM ships.

From this awareness evolved not only the need for improved MCM forces in the Navy as a whole, but also the more novel solution of battle group ships deploying their own MCM assets. For while forward-deployment of a limited number of dedicated minehunting and minesweeping ships in the Western Pacific and Arabian Gulf reduces the time to respond, the thinking is that any delay is unacceptable for many likely contingencies.

The new thinking around organic mine countermeasures was spelled out for the first time in 1995 when the Chief of Naval Operations drew up a concept of operations for organic offboard mine reconnaissance. It coincided with the ever-increasing threat to maritime and naval shipping from mines. The fourth edition (2001) of the U.S. Naval Mine Warfare Plan notes that the "number of countries with mines, mining assets, mine manufacturing capabilities, and the intention to export mines has grown dramatically in the past decade. More than 50 countries currently possess mines and mining capabilities, a 40 percent increase since 1986. Of these, at least 30 countries have demonstrated a mine production capability, and 20 have attempted to export these weapons."

### Evolution of A Remote Minehunter

The evolution of a Remote Minehunting System

(RMS) prior to WLD-1 dates back to the early 1990s when the USN began exploring options for mine reconnaissance from surface combatants.

A vehicle initially developed for hydrographic survey in the 1980s by Rockwell International was used by the Naval Surface Warfare Center to prove initial hydrodynamics, telemetry and the concept of towing a VDS behind a remotely operated vehicle. By 1994, the Navy had developed the first RMS prototype, which demonstrated mine reconnaissance using a VDS winch and pylon welded to the RMV's belly. Though launch and recovery was from shore, command and control was demonstrated from a military van aboard a Spruance class destroyer.

In 1996, the same prototype system vehicle was launched and recovered from another destroyer using a modified gravity davit. Later, in January 1997, during exercises in the Arabian Gulf, the system successfully detected, classified and localized training mines from the destroyer USS Cushing. Extensive at-sea Builder's Trails following in late 1998 showed the RMV could travel with full stability at speeds greater than 10 knots. Stability was a key USN requirement. A smooth riding RMV and VDS under water is crucial to eliminate the

The communications mast is the only feature visible above the water surface of the U.S. Navy's Remote Minehunting Vehicle (RMV), currently in the final stages of testing at Lockheed Martin. The RMV searches for sea mines by deploying and towing a variable depth sensor along a pre-programmed search track.

*(All photos are permission of Lockheed Martin Naval Electronics & Surveillance Systems)*

equivalent of camera shake, which otherwise would return fuzzy sensor imagery. In 1999, Lockheed Martin was awarded the WLD-1 design and development (Phase I) contract. Critical Item Tests begun in the summer of 2000 validated higher speeds, shipboard launch and recovery in varying sea states, and important RMV design characteristics, including control surfaces, stability/controllability algorithms, propulsor blade attachments and radiated noise measurements. Shore based RMV control and operations also were validated. A final series of tests in the winter of 2001-02 showed the RMV has the speed and endurance to perform with the VDS in both hull mount and towed modes, and can deploy and retrieve the VDS while underway. Company officials say these tests cumulatively paved the way for a successful Critical Design Review in December 2001.

### Concept of Operations

When a WLD-1 equipped destroyer enters a littoral zone where sea mines are suspected, mission planners will divide an area to be searched into sectors, and assign 'waypoints' to define the search track. The search area could be within line-of-site of the host ship or over the horizon. Waypoints (as determined by GPS coordinates) are programmed into the RMV before launch using the Mine Warfare Environment Decision Aids Library (MEDAL) system. Once a waypoint is reached, the RMV autonomously initiates pre-programmed commands, such as speed and course changes or VDS deployment and retrieval.

The 13,000-lb RMV is launched via an overboarding davit that extends just beyond the ship's hull. After the mast is raised and communications established, the davit lowers the RMV into the water. A sailor on the host ship uses a remote operator pack strapped to his waist to pilot the RMV far enough away from the ship's hull until the sonar operator can take control.

With its powerful Cummins diesel marine engine, the RMV transits just beneath the surface at sustained speeds in excess of 16 knots with only a few feet of mast extending above the water line. The RMV may conduct mine reconnaissance with its VDS hull mounted in shallow water, or automatically deploy the VDS at a programmed waypoint. The sonar search is conducted at speeds up to 12 knots.

A common sensor with the Airborne MCM community, Raytheon's AQS-20 VDS employs four different sonars (ahead-look, volume search, side-look and gap filler) to detect, localize and classify bottom, close-tethered and moored mines. Contacts classified by sonar-processing algorithms as 'mine-like' can be positively identified using the VDS' high-resolution elec-

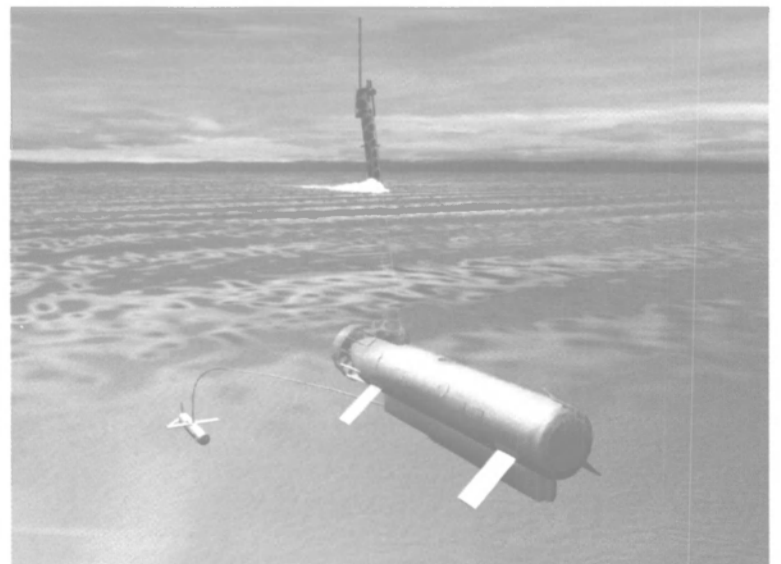

All The Information You Need In One Place.

# 2002 Global Marine Directory CD

Version 3.1

## Over 100,000 records!

- Vessel Owners:**  
 Key personnel, phone, fax, e-mail and details on over 60,000 commercial vessels!
- Commercial Fishing Vessel Owners:**  
 Complete details on over 30,000 vessels.
- Shipbuilders/Rig Builders:**  
 All the major builders/repairers of the world's commercial fleets and offshore rigs.
- Marine Suppliers/Manufacturers:**  
 The marine industry's leading suppliers for every conceivable kind of equipment, product or service.
- Shallow Draft/Offshore:**  
 The world's leading offshore drilling contractors and shallow draft vessel owners/operators of: Tugs, Tow Boats Barges, Ferries, Patrol Craft, Excursion Vessels, Pilot Boats ...
- Easy to use:** All information is fully indexed alphabetically/geographically.
- Generate professional reports and address labels.

The image shows three screenshots of the software interface. The top screenshot shows search filters for Company, Vessel, Hail Port, Business, Country, and State. The middle screenshot shows a table of vessel records with columns for Vessel No., Hailing, Vessel Name, Gross Tons, Net Tons, HP, Length, and Depth. The bottom screenshot shows a detailed record for a company named 'A & K FISHERY', including contact information and a list of other companies in the same region.

Quantities are limited so order today!

Call: 1-212-477-6700

FOR FAST SERVICE, FAX TO: 1-212-254-6271

- Standard:** \$249.00     
  **Deluxe:** 2 quarterly updates with 10,000 additions and revisions. \$299.00     
  **Professional:** 4 quarterly updates with 20,000 additions and revisions. \$349.00

Name: \_\_\_\_\_  
 Company: \_\_\_\_\_  
 Address: \_\_\_\_\_  
 City: \_\_\_\_\_ State: \_\_\_\_\_  
 Postal Code: \_\_\_\_\_ Country: \_\_\_\_\_  
 Phone: \_\_\_\_\_  
 Fax: \_\_\_\_\_  
 E-mail: \_\_\_\_\_

Payment:  Bill Me     Check enclosed  
 Please charge my credit card



Account #: \_\_\_\_\_  
 Exp. Date: \_\_\_\_\_

OR MAIL TO: Maritime Reporter, 118 East 25th Street, New York, NY 10010

\*System Requirements: Windows/PC Platform, 32 MB Ram, 30 MB of available hard disk space.

© 2001 Maritime Activity Reports

## Sea Technology

tro-optical laser imager.

Sensor data and obstacle avoidance video imagery returned by the RMV via line-of-sight or over the horizon data links are monitored by a sonar operator using the host ship's AN/UYQ-70 sonar console, which links with ship's AN/SQQ-89 undersea warfare system. Image data is also stored in the RMV's on-board recorder for post mission analysis. Until recovered (approximately 24 hours or more later), or when commanded otherwise, the RMV will independently perform mine reconnaissance across the designated search area, allowing the host ship to conduct other operations. If necessary, the operator can use the console to manually adjust the RMV's course and speed while it searches for mines.

If an emergent threat to the host ship (a submarine for instance) requires use of the sonar consoles while the RMV is searching for mines, the ship's CO can command the RMV to continue autonomously, direct it to a new rendezvous point, or power down the system to "station keeping/sleep mode" until reactivated.

### Multi Mission Capabilities

While the USN may be alone in its requirement for

an organic approach to littoral mine reconnaissance, the applications for WLD-1 as a platform for multi-mission tasking are extensive and varied.

First to mind is its supplemental use as an intelligence collection device close in shore where it is more difficult to deploy a submarine. Lockheed Martin is currently evaluating the system's potential for Naval Coastal Warfare, Force Protection and Anti-Terrorism applications. Such shallow water missions would complement maritime coastal defense, as well as protection of ports, harbors and anchorages. Using the RMV with its VDS, regional defense forces could conduct active anti-submarine warfare (ASW) operations. Seabed mapping, Q-route surveying and shallow water battlespace profiling are other obvious applications. As a surface surveillance data collector close to shore, the RMV mast could be outfitted with high-resolution optical sensors, such as low-level light cameras, infrared sensors, and surface search radar.

The RMV could become a low-risk platform to collect communications, signal and electronic intelligence. It could fill in any coverage gaps by other collectors, such as submarines or satellites. The RMV could also serve as a communications relay between surface craft, other UVs and command centers. Future variants of WLD-1 may feature a lighter, smaller RMV with automated launch and recovery, increased sensor area coverage rate, and enhanced obstacle avoidance features. In many cases, the system would be launched from a pier or ship of opportunity, with data fed to a portable command and control van on shore.

### Fleet Introduction and Acceptance

Fleet introduction of WLD-1(V)1 will occur after new tactical doctrine has been approved,

and the system tested at sea by a DDG91 ship's company in 2004-5. Lessons learned from those tests will determine the best ways to incorporate WLD-1 operations and procedures for follow-on ships without adversely impacting their primary mission.

Arguably the biggest near-term challenge is to overcome ships captains' and fleet commanders' concern about having the system on board, particularly given the traditional reliance on dedicated minehunters to perform MCM.

Complementary to that goal is the need to train personnel to become expert in the technical, tactical and operational role of organic mine warfare.

On paper at least, a good indication of the evolving mindset toward mine countermeasures of the future is how the USN uses terminology. Already the term "organic" is giving way to the term "assigned" - the latter term implying greater permanency. So too the term "dedicated" as applied to fixed mine warfare forces, such as minehunting ships, is being replaced by the term "supporting" - as in supporting carrier and amphibious groups that will find and neutralize mines with their own "assigned" MCM assets.

Ultimately, operational success, not terminology, will convince COs of WLD-1's viability in battle conditions. But just as unmanned airborne vehicles have become indispensable battle tools, so too will unmanned semi-submersible vehicles like the RMV. The success of unmanned aerial vehicles in Afghanistan, and calls by President George W. Bush and U.S. Secretary of Defense Donald H. Rumsfeld for more "transforming technologies," should ensure WLD-1 gets top-level support.

*The preceding article was first published in the April 2002 issue of World Defence Systems.*



## GIVE US THREE INCHES.

### And We Will Replace Your Old Marine Refrigerator.

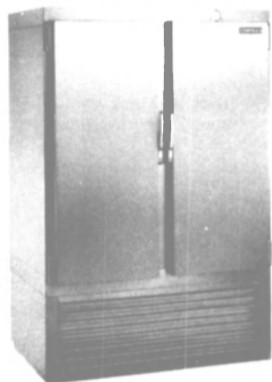

Three inches clearance from the front. That's all we need to replace your old marine refrigerator with a Cospolich modular refrigerator.

Do it yourself. No bulkhead or hatch cuts. No special skills or tools required. Kits come with easy, step-by-step instructions. Polarized wiring is pre-installed so it can't be plugged in wrong.

With models from 20 cu. ft. to 200 cu. ft., all built to U.S. Navy standards, it's like having a refrigerator built to your specifications.

## COSPOLICH

### REFRIGERATOR CO.

P.O. Box 1206 Destrehan, LA 70047  
Tel: 985-725-0222 • Fax: 985-725-1564  
Toll Free: 800-423-7761  
www.cospolich.com

Circle 351 on Reader Service Card  
or visit [www.maritimereporterinfo.com](http://www.maritimereporterinfo.com)

## San Diego Shipyard Wins Ship Repair Contract

United Defense Industries, Inc. announced that the U.S. Navy's award to Southwest Marine (SWM) of the advanced planning segment of the contract for dry docking and pier side work on the USS LAKE CHAMPLAIN (CG-57), a Ticonderoga-class Aegis cruiser home-ported in San Diego. Southwest Marine is a member of United States Marine Repair, Inc. (USMR), which was acquired by United Defense last month.

The advanced planning segment of the contract is valued at \$518,484. With funded options, the total contract value is in excess of \$12 million. SWM is the prime contractor and has teamed with National Steel and Shipbuilding Company and Continental Maritime of San Diego to perform the work. The ship is scheduled to arrive at SWM on September

18, 2002, and work is expected to be completed on November 20, 2002.

## Keppel Offshore and Marine Units Win Contracts

Keppel Corporation Limited, through its offshore and marine units in Keppel Offshore & Marine Ltd (Keppel O&M), has clinched contracts worth a total of \$41 million from repeat customers.

Three contracts over \$28 million are for the upgrades of jack-up rig Ensco 81 and barge drilling unit Ensco 1 from Ensco Offshore Company (ENSCO), and swamp barge Maera from PT Apexindo Pratama Duta, an Indonesian drilling contractor. Another contract is for a new Anchor Handling Tug/Supply (AHTS) vessel for Pacific Richfield Marine Pte Ltd, owner and operator of OSVs in the Asia and Pacific region.

## U.S. Navy Awards \$2.8M Contract To GD

The U.S. Navy has awarded Electric Boat a \$2.8 million contract to perform planning work for maintenance on the USS Toledo (SSN-769). Electric Boat is a wholly owned subsidiary of General Dynamics. Under the terms of the contract, Electric Boat will immediately begin advanced planning for a 60-day maintenance period known as a Selected Restricted Availability (SRA). The SRA is scheduled to start at the Naval Submarine Base in Groton in April 2003.

## NAPIER Turbochargers - for all your turbocharging needs

NAPIER Turbochargers offers an extensive range of products and services to fulfil your turbocharging needs:

- New Equipment Sales • Field Service
- Spare Parts - New and Remanufactured
- Service Exchange • Overhaul
- Retrofit - Replacement and Upgrade

Let NAPIER Turbochargers transform your requirements into winning solutions

NAPIER Turbochargers PO Box 1 Waterside South Lincoln LN5 7FD England  
Tel: 44 (0) 1522 584000 Fax: 44 (0) 1522 584910  
email: [napiersales@power.alstom.com](mailto:napiersales@power.alstom.com) [www.power.alstom.com](http://www.power.alstom.com)

## ALSTOM

[www.power.alstom.com](http://www.power.alstom.com)

Circle 352 on Reader Service Card or visit [www.maritimereporterinfo.com](http://www.maritimereporterinfo.com)

# Pitch black. 12-foot seas. Follow the light.



## The NEW Standard Horizon SPECTRUM+ VHF radio is all you need.

The warm glow from the oversized backlit display gives you a comforting feeling when things get a little hairy. But then, everything about the Spectrum+ gives you a comforting feeling of confidence.



RAM  
Microphone

- Integrated 20W hailer/PA with fog signals
- ClearVoice™ noise-canceling speaker microphone
- Optional RAM Microphone for full-function dual-station operation (available in white and black)
- Large display indicates lat/long, SOG, COG and more
- Channel naming feature option lets you customize channel names
- Full DSC capability
- 3-year Waterproof Warranty

See it for yourself. Get specs and where-to-buy info at [www.standardhorizon.com](http://www.standardhorizon.com).



**STANDARD HORIZON**  
Marine Division of Vertex Standard

[www.standardhorizon.com](http://www.standardhorizon.com) • 714-827-7600

Circle 355 on Reader Service Card or visit [www.maritimereporterinfo.com](http://www.maritimereporterinfo.com)

## Show Previews

# Interactive Format for Repair and Conversion's Main Event



Product launches, company presentations and discussion-based conference and workshop formats will underline a "hands on" theme at Shiprepair & Conversion 2002, the 11th anniversary of the industry's leading trade fair which takes place in London's Grand Hall, Olympia, on November 27-28.

Innovations prompted by feedback from last year's show — which attracted more than 2,500 visitors and 300 exhibitors from 45 countries — include a fully-equipped presentation/demonstration area and a debate-led conference program, with delegate fees set at just \$192 to provide value for money and broaden participation.

### An Exhibition For All Seasons

Marine consultancy British Maritime Technology (stand C23) is using the presentation facility to host a briefing on its expanded surveying capability — the company has acquired P De Beer & Co — and the creation of a new business unit handling reliability, risk and safety management.

On stand B27, Furmanite will feature its new Scitech portable spark erosion kit, which enables stud removal on-site despite restricted headroom or very tough materials. The process was used recently when a cylinder head stud broke on P&O Stena's Provence, the job being completed within 24 hours while the ferry was in transit.

Cargo equipment specialist MacGregor Group (F26) is exhibiting conversion and upgrading products including Flexipad hatch cover bearings. Among latest retrofits, some 574 pads were installed on P&O Nedlloyd's 1992-built 4,230 teu containership Jervis Bay in June.

ABB Ltd (F38) is unveiling the TPS-F33 turbocharger series for diesel and gas engines, which is interchangeable with the current TPS-D/E series and offers increased pressure ratios and flow capacity via an aluminium alloy com-

pressor wheel. Meanwhile Simplex-Turbulo (E16) is promoting its new diesel services division, CD92 heavy fuel oil micronising unit and, as UK agents, a Nimonic valve remanufacturing service launched by Markisches Werk Halver.

First-time exhibitor Whessoe Europe/Total Automation (C15) will launch its portable level/temperature oil-water interface instrument and European service facility. Bond Instrumentation (G34) is marketing new alarm, monitoring and control systems while Atlantis Marine (H9) is introducing the VideoRay ROV underwater inspection system and Nauticast X-pack AIS transponder, a new SOLAS solution.

Survival Inspectorate (G25) will present its new DNV approved Safelaunch lifeboat release hook with a working model and video presentation highlighting three key design features which minimise accidental release.

Among shiprepairers promoting new facilities, A&P Group (D3) is featuring its recently acquired Aberdeen, Birkenhead (Mersey) and Hebburn (Tyne) yards, which increase its U.K. drydock total from eight to 14. The new yards will also offer the A&P Shipcare afloat repairs service available at the existing Tyne, Falmouth and Southampton yards and five smaller facilities.

Northwestern Shiprepairers (C5), which started trading at six Merseyside sites in June last year, will focus on a major investment programme providing new workshop facilities, craneage and general infrastructure improvements at Bidston and Canada drydocks.

The 2002-3 Owners Guide to UK Yards will be available from the Shipbuilders and Shiprepairers Association (G5) together with case studies from its R&D and MasterClass yard improvement projects.

### Discussion Forum for Industry's Hot Topics

Like previous events, the Shiprepair & Conversion 2002 conference will feature leading figures from yards, agents, owners, managers, classification societies and suppliers - but in a major change of emphasis, their input will be to set the scene for a series of debates open to full delegate participation.

The opening State of the Industry session will range from market demand to yard survival strategies, followed by debates on repair and conversion issues including yard selection, extras, customer satisfaction, riding crews, safety, on-site supervision, regulatory bodies, skilled manpower shortages and the use of sub-contractors.

Day two starts with maintenance debates covering coatings, corrosion, costings, methods, technologies, spares supply and planned maintenance. The concluding debates will focus on shipyard issues — setting up a new yard, alliances, improving performance, safety and risk, environmental standards and legal liabilities.

### One-Day Workshop Wraps Up Contract Negotiation

In addition to the conference, a pre-conference workshop on negotiating for newbuilding, conversion and repair contracts is being held at the Hilton London Olympia on November 26. This one-day intensive workshop will examine the key issues and differences in all aspects of contract negotiation from both owner and shipyard perspectives.

Full exhibition, conference and workshop, organised by Lloyd's List Events are available on the event website - [www.shiprepair.com](http://www.shiprepair.com) - which includes booking information and on-line registration. Stand space can also be reserved via **Mark Lewis** on Tel +44 (0)20 7553 1732.

Circle 79 on Reader Service Card  
[www.maritimereporterinfo.com](http://www.maritimereporterinfo.com)

## New England's Fall Foliage Is Setting For SNAME 2002

This year's SNAME Annual Meeting and International Maritime Exposition blends the big city atmosphere of Boston's diverse culture and history with New England maritime history. The event will be held at the Westin Copley Place in Boston from Tuesday, September 24 - Friday, September 27. The exhibition, will bring together professionals from all corners of the maritime world, from both the technical and business sides.



Matson's new 2,600-TEU containership being built at Kvaerner Philadelphia.

In addition, to the traditional display of the newest industry wares in the exhibition hall, SNAME 2002 will also feature a technical program featuring the most innovative developments in shipbuilding and ship design, as well as a new program on the hot topic of the times - maritime security. This new seminar will cover the need, as well as what steps need to be taken by the maritime industry to hinder potential terrorist attacks and/or threats.

The Exposition also includes the 2002 Ship Production Symposium, which is supported through research from a variety of groups, including the National Shipbuilding Research Program Advanced Enterprise (NSRP ASE). Coupled with the exposition and meeting, the Symposium aims to support the progression of U.S. Shipyards - both on the commercial and naval sides.

Regarding the technical program, featured discussions include Naval Architecture and Marine Engineering, which will review the principles and development of lines drawing, ship hydrostatics and longitudinal strength. The Maritime Security Forum held on Thursday, September 26, will consist of two panels of experts that will discuss Maritime Security and the Design of Ships, and Maritime Security and the Operation of Ships.

A variety of papers will also be presented on: "A Risk-Based Compliance for Engineering Systems," by **Robb C. Wilcox** and **Bilal M. Ayyub**; "A Marine Forensic Analysis of the HMS Hood and the DKM Bismarck," by **William Jurens**, **William H. Garzke, Jr.**, **Robert O. Dulin, Jr.**, **John Roberts** and **Richard P. Fiske**; and "Joint Seakeeping Response Processes for Determining Structural Loads," by **Bruce L. Hutchison**.

For further information, or to exhibit, please contact: **Susan Giver**, exposition manager, SNAME, 601 Pavonia Ave., Jersey City, N.J. 07306, tel: (201) 798-4800 or (412) 741-0995; e-mail: [sgiver@sname.org](mailto:sgiver@sname.org).



# Pitch black. 12-foot seas. Follow the Light.



## The NEW Standard Horizon SPECTRUM+ VHF radio is all you need.

The warm glow from the oversized backlit display gives you a comforting feeling when things get a little hairy. But then, everything about the Spectrum+ gives you a comforting feeling of confidence.



RAM  
Microphone

- Integrated 20W hailer/PA with fog signals
- ClearVoice™ noise-canceling speaker microphone
- Optional RAM Microphone for full-function dual-station operation (available in white and black)
- Large display indicates lat/long, SOG, COG and more
- Channel naming feature option lets you customize channel names
- Full DSC capability
- 3-year Waterproof Warranty

See it for yourself. Get specs and where-to-buy info at [www.standardhorizon.com](http://www.standardhorizon.com).



**STANDARD HORIZON**  
Marine Division of Vertex Standard

[www.standardhorizon.com](http://www.standardhorizon.com) • 714-827-7600

Circle 355 on Reader Service Card or visit [www.maritimereporterinfo.com](http://www.maritimereporterinfo.com)

## Show Previews

# Interactive Format for Repair and Conversion's Main Event



Product launches, company presentations and discussion-based conference and workshop formats will underline a "hands on" theme at Shiprepair & Conversion 2002, the 11th anniversary of the industry's leading trade fair which takes place in London's Grand Hall, Olympia, on November 27-28.

Innovations prompted by feedback from last year's show — which attracted more than 2,500 visitors and 300 exhibitors from 45 countries — include a fully-equipped presentation/demonstration area and a debate-led conference program, with delegate fees set at just \$192 to provide value for money and broaden participation.

### An Exhibition For All Seasons

Marine consultancy British Maritime Technology (stand C23) is using the presentation facility to host a briefing on its expanded surveying capability — the company has acquired P De Beer & Co — and the creation of a new business unit handling reliability, risk and safety management.

On stand B27, Furmanite will feature its new Scitech portable spark erosion kit, which enables stud removal on-site despite restricted headroom or very tough materials. The process was used recently when a cylinder head stud broke on P&O Stena's Provence, the job being completed within 24 hours while the ferry was in transit.

Cargo equipment specialist MacGregor Group (F26) is exhibiting conversion and upgrading products including Flexipad hatch cover bearings. Among latest retrofits, some 574 pads were installed on P&O Nedlloyd's 1992-built 4,230 teu containership Jervis Bay in June.

ABB Ltd (F38) is unveiling the TPS-F33 turbocharger series for diesel and gas engines, which is interchangeable with the current TPS-D/E series and offers increased pressure ratios and flow capacity via an aluminium alloy com-

pressor wheel. Meanwhile Simplex-Turbulo (E16) is promoting its new diesel services division, CD92 heavy fuel oil micronising unit and, as UK agents, a Nimonic valve remanufacturing service launched by Markisches Werk Halver.

First-time exhibitor Whessoe Europe/Total Automation (C15) will launch its portable level/temperature oil-water interface instrument and European service facility. Bond Instrumentation (G34) is marketing new alarm, monitoring and control systems while Atlantas Marine (H9) is introducing the VideoRay ROV underwater inspection system and Nauticast X-pack AIS transponder, a new SOLAS solution.

Survival Inspectorate (G25) will present its new DNV approved Safelaunch lifeboat release hook with a working model and video presentation highlighting three key design features which minimise accidental release.

Among shiprepairers promoting new facilities, A&P Group (D3) is featuring its recently acquired Aberdeen, Birkenhead (Mersey) and Hebburn (Tyne) yards, which increase its U.K. drydock total from eight to 14. The new yards will also offer the A&P Shipcare afloat repairs service available at the existing Tyne, Falmouth and Southampton yards and five smaller facilities.

Northwestern Shiprepairers (C5), which started trading at six Merseyside sites in June last year, will focus on a major investment programme providing new workshop facilities, craneage and general infrastructure improvements at Bidston and Canada drydocks.

The 2002-3 Owners Guide to UK Yards will be available from the Shipbuilders and Shiprepairers Association (G5) together with case studies from its R&D and MasterClass yard improvement projects.

### Discussion Forum for Industry's Hot Topics

Like previous events, the Shiprepair & Conversion 2002 conference will feature leading figures from yards, agents, owners, managers, classification societies and suppliers — but in a major change of emphasis, their input will be to set the scene for a series of debates open to full delegate participation.

The opening State of the Industry session will range from market demand to yard survival strategies, followed by debates on repair and conversion issues including yard selection, extras, customer satisfaction, riding crews, safety, on-site supervision, regulatory bodies, skilled manpower shortages and the use of sub-contractors.

Day two starts with maintenance debates covering coatings, corrosion, costings, methods, technologies, spares supply and planned maintenance. The concluding debates will focus on shipyard issues — setting up a new yard, alliances, improving performance, safety and risk, environmental standards and legal liabilities.

### One-Day Workshop Wraps Up Contract Negotiation

In addition to the conference, a pre-conference workshop on negotiating for newbuilding, conversion and repair contracts is being held at the Hilton London Olympia on November 26. This one-day intensive workshop will examine the key issues and differences in all aspects of contract negotiation from both owner and shipyard perspectives.

Full exhibition, conference and workshop, organised by Lloyd's List Events are available on the event website — [www.shiprepair.com](http://www.shiprepair.com) — which includes booking information and on-line registration. Stand space can also be reserved via Mark Lewis on Tel +44 (0)20 7553 1732.

Circle 79 on Reader Service Card  
[www.maritimereporterinfo.com](http://www.maritimereporterinfo.com)

## New England's Fall Foliage Is Setting For SNAME 2002

This year's SNAME Annual Meeting and International Maritime Exposition blends the big city atmosphere of Boston's diverse culture and history with New England maritime history. The event will be held at the Westin Copley Place in Boston from Tuesday, September 24 - Friday, September 27. The exhibition, will bring together professionals from all corners of the maritime world, from both the technical and business sides.



Matson's new 2,600-TEU containership being built at Kvaerner Philadelphia.

In addition, to the traditional display of the newest industry wares in the exhibition hall, SNAME 2002 will also feature a technical program featuring the most innovative developments in shipbuilding and ship design, as well as a new program on the hot topic of the times — maritime security. This new seminar will cover the need, as well as what steps need to be taken by the maritime industry to hinder potential terrorist attacks and/or threats.

The Exposition also includes the 2002 Ship Production Symposium, which is supported through research from a variety of groups, including the National Shipbuilding Research Program Advanced Enterprise (NSRP ASE). Coupled with the exposition and meeting, the Symposium aims to support the progression of U.S. Shipyards — both on the commercial and naval sides.

Regarding the technical program, featured discussions include Naval Architecture and Marine Engineering, which will review the principles and development of lines drawing, ship hydrostatics and longitudinal strength. The Maritime Security Forum held on Thursday, September 26, will consist of two panels of experts that will discuss Maritime Security and the Design of Ships, and Maritime Security and the Operation of Ships.

A variety of papers will also be presented on: "A Risk-Based Compliance for Engineering Systems," by Robb C. Wilcox and Bilal M. Ayyub; "A Marine Forensic Analysis of the HMS Hood and the DKM Bismarck," by William Jurens, William H. Garzke, Jr., Robert O. Dulin, Jr., John Roberts and Richard P. Fiske; and "Joint Seakeeping Response Processes for Determining Structural Loads," by Bruce L. Hutchison.

For further information, or to exhibit, please contact: Susan Giver, exposition manager, SNAME, 601 Pavonia Ave., Jersey City, N.J. 07306. tel: (201) 798-4800 or (412) 741-0995; e-mail: [sgiver@sname.org](mailto:sgiver@sname.org).

## Fleet Privatizations Expected Soon For Lithuanian Companies

Following are financial details of a planned fleet privatization in Lithuania. **JSC Klaipeda Transport Fleet (KTF)** ([www.transfleet.lt](http://www.transfleet.lt)) is one of the largest Lithuanian shipping companies, whose principal activities are transportation of refrigerated cargo by sea and lease of sea transport vessels. The authorized capital of the company as of December 31, 2001 amounted to about \$38.4 million. KTF owns and operates 16 small- and medium-sized cargo reefers. The main cargo handled by the company includes frozen fish, meat, chicken, butter, fruits and vegetables. The capacity of KTF's vessels is from 85,000 to 470,000 cu. ft., the average capacity — 189,000 cu. ft. The total capacity of the fleet is 85,664 cu. m. According to this class of vessels, the company's fleet is the fourth largest fleet in the world. The main foreign competitors include Seatrade (U.S.), East Wind (U.S.), GRL (Global Reefer Transport, Great Britain) and other smaller companies. The company is a shareholder in the Germany-based vessel chartering company Alpha Reefer Transport with 20 percent share in this company.

**JSC Lithuanian Shipping Company (LSC)** was established on June 27, 2001, following the reorganization of JSC Lithuanian Shipping Company (LISCO) by splitting it into two business entities: LISCO and LSC. The authorized capital of the company as of December 31, 2001, amounted to \$57.3 million. At the end of 2001, after the reorganization, LSC owned 19 vessels (169.4 thousand DWT). In 2002, the company bought two more vessels (19,300 DWT). The main foreign LSC's competitors are Baltic and Scandinavian shipping companies. *Rutkauskas, Skyrius & Partners, a consulting firm in Vilnius, Lithuania, invites all parties interested in participation in privatisation to submit their Expression of Interest. The privatisation process is planned to start in October-November 2002. Contact person: Rimvydas Skyrius; E-mail: [rspconsult@takas.lt](mailto:rspconsult@takas.lt); tel: +370-5-212 30 15, +370-5-212 28 08; fax: +370-2-62 38 66.*

Table 1 Main features of the vessels of KTF			
Name	Year built	Capacity	Speed
SEDA	1985	470000	15.5
IGNALINA	1983	466000	15.5
SEAFROST	1993	255000	15.5
ARGO	1985	181000	15.5
SATURNAS	1982	156000	13
VEGA	1982	153000	14.5
TUKANAS	1982	149000	14
PEGASAS	1980	137000	12
ORIONAS	1979	130000	13.5
PLUTONAS	1979	120000	13
RAMBYNAS	1985	107000	13
ZALGIRIS	1985	107000	13
LYRA	1991	237000	14.5
KASTYTIS	1978	85000	12.5
JUPITERIS	1978	85000	12.5
MARSAS	1989	189000	14.5

Table 2 Main features of the vessels of LSC			
Ship name	Year built	DWT	Use
Daina	1998	5,423	Dry cargo
Audre	1997	5,423	
Akville	1997	5,423	
Asta	1996	5,423	
Algirdas	1991	4,160	General cargo
Mindaugas	1992	4,160	
Voke	1990	5,985	
Musa	1993	4,480	
Veljuona	1973	4,054	
Medininkai	1974	4,054	
Kreva	1974	4,054	
Kap. Kaminskis	1978	14,632	Bulk cargo
Kap. Stulpinas	1981	14,550	
Kap. Simkus	1976	14,632	
Kap. Serafinas	1980	14,550	
Kap. Andzejauskas	1978	14,550	
Kap. Marcinkus	1977	14,632	
Kap. A. Lucka	1980	14,550	
Kap. Domeika	1979	14,632	
Staris*	1985	9,650	Dry cargo
Svilas*	1985	9,650	

\* - vessels were purchased in 2002

Key data on KTF's performance		
Financial indices (mil.LTL)		
	Dec. 31 '00	Dec. 31 '01
Assets	170,209	169,236
Sales and services	71,035	80,060
Total profit	11,405	9,482
Operational costs	4,999	5,117
Operational profit	6,406	4,365
Net profit	10,899	4,034

Financial indices (mil.LTL)	
	2001.12.31
Assets	305.2
Sales and services	46.87



See us at SMM, hall 2 first floor stand no 2047  
 Manufacturer of advanced



Phone +47 37 06 37 00 Fax +47 37 06 37 06  
 e-mail: [cctv@hernis.no](mailto:cctv@hernis.no) Internet: [www.hernis.com](http://www.hernis.com)

Circle 354 on Reader Service Card or visit [www.maritimereporterinfo.com](http://www.maritimereporterinfo.com)

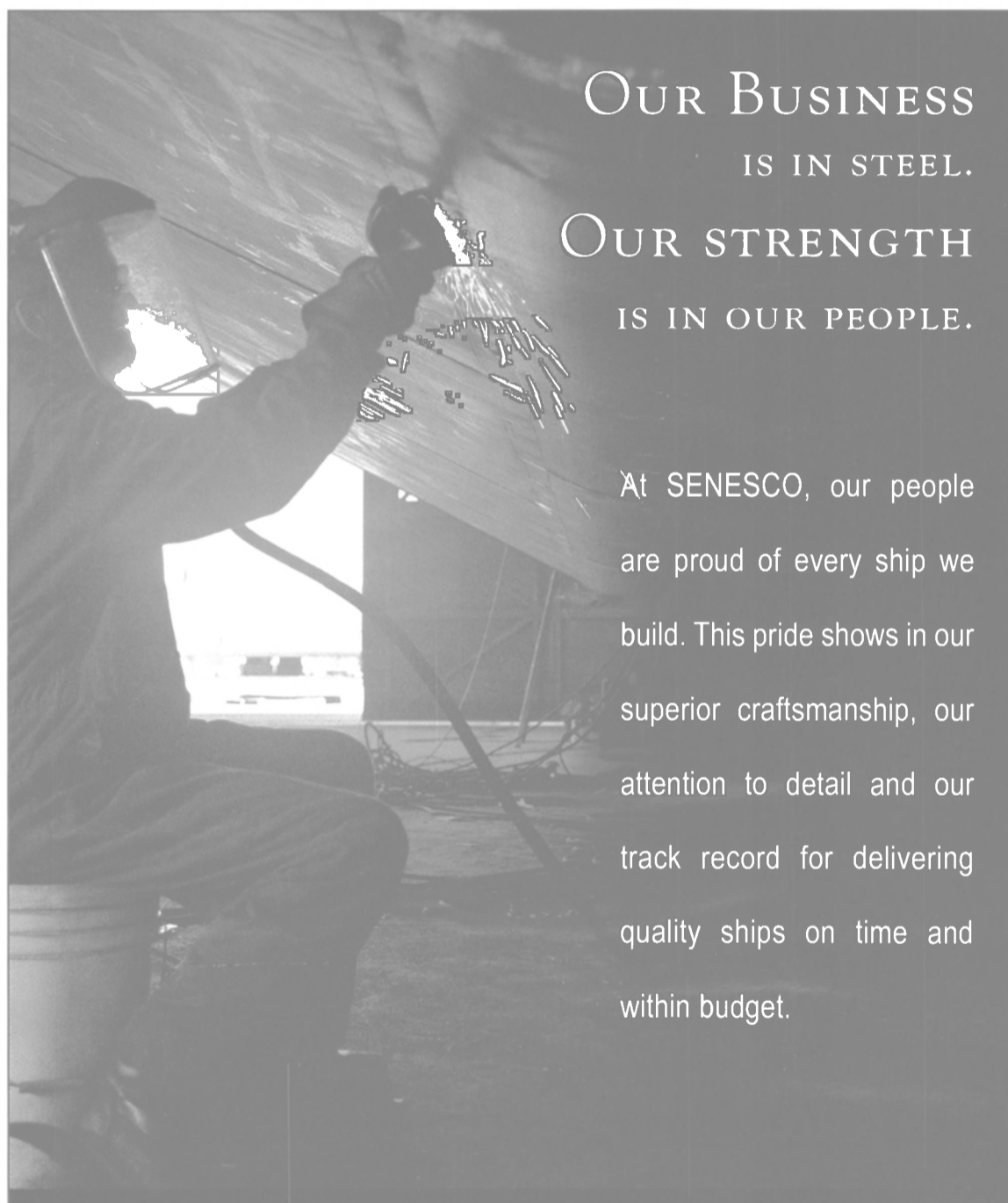

OUR BUSINESS  
 IS IN STEEL.  
 OUR STRENGTH  
 IS IN OUR PEOPLE.

At SENESCO, our people are proud of every ship we build. This pride shows in our superior craftsmanship, our attention to detail and our track record for delivering quality ships on time and within budget.

PROUDLY MADE. AMERICAN BUILT.

To learn more about SENESCO's extensive line of fuel barges, hopper barges and crane/work barges, as well as our alternative steel fabrication and dry dock ship repair services, call Bob Jarvis or Richard Carpenter at 1-401-295-0373 or visit our website at



[www.senescomarine.com](http://www.senescomarine.com)

**SENESCO**

Circle 356 on Reader Service Card or visit [www.maritimereporterinfo.com](http://www.maritimereporterinfo.com)

# Halter is Back

Anil Raj, president and COO of Halter Marine, in many ways embodies the company for which he has worked for the last 15 years. Joining as the Director, Engineering, Production Controls and Procurement in 1987, Raj has relied on a solid technical foundation, first to help establish and continue the compa-

ny's reputation as one of the world's most prolific builders of ships and boats, and second to help the company hang on — to customers as well as key technical and production staff, as the company navigated the tumultuous environs following its Chapter 11 filing of April 2001. Despite well-chronicled skepticism, Halter today sits on the verge of a remarkable rebound that could again make it a ubiquitous presence in both commercial and military marine construction.

— by Greg Trauthwein

"Every adversity has a blessing," Raj said. While he readily admits that the period of Chapter 11 "has not been kind to the company," he revels in the fact that Halter Marine has, since its Chapter 11 filing delivered more than \$250 million worth of vessels and won contracts, which including options are worth more than \$275 million. While this level is a far cry from the amount of business conducted pre-Chapter 11 filing, he believes it a strong indicator of the company's willingness and ability to continue despite the financial problems, problems brought on primarily by drain on cash liquidity due to two bad contracts not associated to Halter, the vessel business unit of Friede Goldman Halter.

"At the time of the filing, the company had barely enough cash to meet two week's payroll and no credit line," Raj said. "The dedicated employees rallied around the need to find a solution. For some time prior to the filing the company's liquidity problem made it difficult to get materials to contracts. This caused the progress on the contracts to slow down. The resultant lack of progress and collection of milestone payments from customers further aggravated the liquidity problem. Immediately after filing, with no line of credit, we had to figure out how to "prime" this cash pump. We made some strategic decisions on how to do this combined with customer and supplier support, helped to put the company in a position where it actually started to accumulate cash."

The massive 40-ft. bowthruster tube for Logistic Support Vessel (LSV) under construction at Halter Moss Point. This contract was one that was instrumental in ensuring a steady workflow at the company during the reorganization.



## We Can Carry the Heavy Load

East Coast Office:  
(617) 261-6696 ext. 301

Gulf Coast Office:  
(985) 631-2785

email & website:  
cec@cashmanequipmentcorp.com  
www.cashmanequipmentcorp.com



Marine & General Contractor

ABS & Inland Barge Rentals

Circle 218 on Reader Service Card or visit [www.maritimereporterinfo.com](http://www.maritimereporterinfo.com)



Orkot® Marine Bearings are offered as custom engineered components (to Ø 2.2m) and as semi-finished tubes and plates with stocks worldwide.

Available in three material grades to perfectly match application requirements.

Classification society approvals.  
24 hour service (United States)

## Orkot® Marine Bearings

A unique synthetic composition and the incorporation of solid lubricants, ensures Orkot® Marine Bearings operate with an exceptionally low co-efficient of friction in seawater, grease, oil and even in dry-running conditions.

- High load tolerance - for applications including crane mast bearings and cylinder rod-end bearings.
- Water lubricated - for rudder and propeller shaft bearings.
- Low friction - suited to hatch cover pads and stabilizer bearings.



**TLM MARINE**  
**TXM MARINE**  
**SLM MARINE**

Polymer sealing solutions

A part of Smiths Group plc

**Busak Shamban**

For immediate contact, call the Orkot information center:  
North/South America Tel: +1(541) 688-5529 Fax: +1(541) 688-2079  
Europe/Middle & Far East Tel: +44(0)1709 376044 Fax: +44(0)1709 374819

**24 hr service (United States): 1-800-546-7568**

Circle 275 on Reader Service Card or visit [www.maritimereporterinfo.com](http://www.maritimereporterinfo.com)

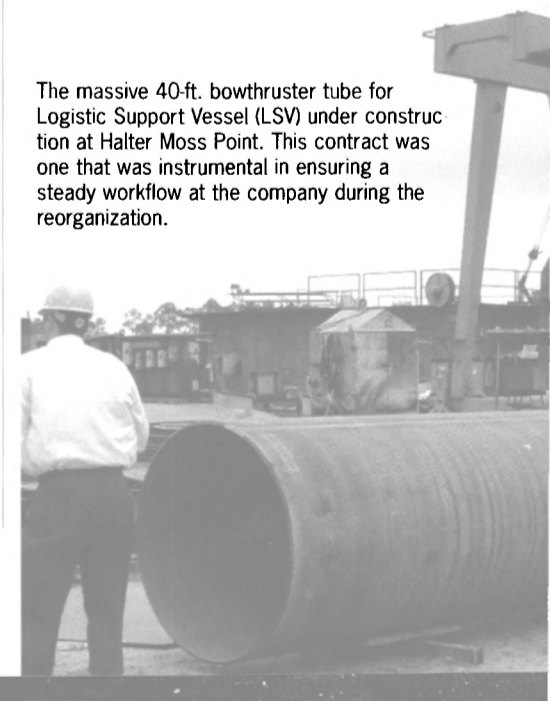



Anil Raj, Halter Marine's president and COO

Raj points out that the sale was also approved by the Presidential Committee for Foreign Investment in the U.S. VT Systems, spear headed by a retired U.S. Army four-star General. **John Coburn**, it also has aerospace operations in Mobile, Alabama, San Antonio, and Dallas, Texas. ST Engineering is a diversified company with extensions in marine, land, aerospace and electronics.

The Halter Marine acquisition is, in essence, the company's marine business in the U.S. While final plans regarding strategies for the former Halter Marine (to now be known as VT Halter) are yet set, Raj stated that it will be treated as an autonomous business unit from the Singapore unit. VT Halter intends to keep substantially all Halter personnel at the time of closing. This includes the man-

agement, technical personnel and production workers of Halter Marine.

**Pride Restored**

Bankruptcy humbles, to put it simply, and while the company retains a solid technical core and a reference list of more than 2,700 vessels, job one will be to re-instill the confidence and swagger that helped lead Halter to the mount

While the last couple of years have been little reason to celebrate for Halter, the fact that Raj and staff are still in Halter's Gulfport, Miss., offices, which is a veritable museum of vessels built over the last four decades, a testament to the nearly 3,000 built by the company since started by **Harold Halter** in 1951 (see related story on page 70), is accomplishment in itself. At the time of *Maritime Reporter's* visit, the company was close to the close of the deal, which would make Vision Technologies Kinetics, Inc. (VTK), a wholly-owned subsidiary of ST Engineering, the new owner of Halter Marine. VTK's \$66 million winning bid gives it Halter Pascagoula, Halter Moss Point, Moss Point Marine, Halter Port Bienville, Halter Lockport and Halter Gulfport East, including the Corporate HQ and Gulfport Central. VTK is actually a unit within VT Systems. It is a unit that has DoD approval to conduct military work for the U.S. Considering Halter's federal contracts, it was decided to structure the acquisition in this manner. "When you have a foreign company, which owns a U.S. company doing military work, there is a well-defined structure to put up a firewall and maintain security," Raj said.

VT Kinetics has a U.S. DoD approved Special Security Agreement and necessary clearances to do classified work.



PROP SHAFT BEARING SYSTEM SOLUTIONS

# Pollution Free Thordon... Welcome In Any Port



Vessels equipped with pollution free Thordon COMPAC open, or Thor-Lube sealed, propeller shaft bearing systems are welcome in any port.

Completely avoid the environmental issues, including delays and fines resulting from an oil sheen produced by even a small amount of stern tube oil leakage.



Thordon marine bearing systems are designed to operate pollution free using only sea water or water-based Thor-Lube lubrication. Reliability, long wear life and superior customer service have made Thordon the first choice for pollution free propeller shaft, rudder, deck equipment, and offshore bearing solutions in new-build, conversion and repair projects.

**THORDON**  
What today's ships are turning to

[www.thordonbearings.com](http://www.thordonbearings.com)

Burlington, Ontario, CANADA • Tel: 1.905.335.1440 • Fax: 1.905.335.4033 Email: [info@thordonbearings.com](mailto:info@thordonbearings.com)

Circle 305 on Reader Service Card or visit [www.maritimereporterinfo.com](http://www.maritimereporterinfo.com)

## Company Profile

many years ago. Raj said that a number of owners withheld orders during the past year and a half due to the bankruptcy proceedings and the uncertain future of the company. He said that a good number of customers stayed the course, signing letters of intent, which turn into contracts once the bankruptcy matter was resolved. In addition, news of the pending deal with VTK he notes that "we have received more inquiry calls in the last week than we had in the previous three months combined." In total, he estimates that the company has approximately \$2 billion worth of proposals currently being evaluated by customers.

Two customers instrumental in ensuring that there is continued work at the Halter yards to allow a steady, if not spectacular, stream of work to ensure that its key technical and production staff stayed adequately busy: the U.S. Army and NOAA, which awarded the company the contract to build one Logistic Support Vessel with an option for two additional units and up to four Fisheries Reserve Vessels. These two contracts, when options are exercised, are worth approximately \$240 million.

While plans regarding the use of Halter facilities will evolve in the coming months, it is a good bet that the company will rely on diversity of product — both commercial and military — to regain its footing. On the defense side, it will be imperative for Halter to project a very "American" image, keeping an arm's length between it and its Singapore connection. Conversely, on the commercial side, the company will rely on the combined strengths inherent in having two strong units literally a world apart. "ST Engineering has a similar product line, but on the higher end and above," Raj said. Both companies have strong international presence, but ST Engineering also has the capabilities to serve the containership and frigate markets, for example. Doubters will surely persist, as the company seeks to retain its status as a leading builder in the GOM and beyond, but Raj is confident that the pieces are in place. "We are now well-capitalized, and we have been able to retain a most of our technical staff, helping to maintain the franchise value." In addition, the thousands of Halter-designed and -built vessels in operation provided the new owner an invaluable tech-

nical database it felt it could not pass. "We don't sell a boat or a ship to our customer... we sell a solution" Raj said. "We have seldom won a contract on low price; rather we have won contracts on our quality and custom solutions. These are aimed at providing superior value to our customers so they can be more competitive."

### In Memoriam: Harold P. Halter

**Harold P. Halter**, a native of New Orleans, died Sunday, July 28, 2002. In 1956, after he and James Dubuisson built a 26-ft. pleasure boat in his back yard, they founded Halter Marine Services, Inc. on Bayou Sauvage in New Orleans East. Halter Marine was responsible for many innovative designs in the ship building industry. Crew boats, supply boats, and tug boats were designed and fabricated for the offshore oil industry. By 1978, Halter Marine was responsible for 49 percent of the world's production of supply boats. The business had grown to include 10 facilities in four states. In 1983, Mr. Halter sold the company to Trinity Industries. In recent years he continued his research and development of offshore boats and equipment and was granted patents on his designs in this area. Mr. Halter founded and served as president of the Louisiana Shipbuilding and Repair Association. He was a member of the City Club of New Orleans, International Trade Mart, Southern Yacht Club and Plimsoll Club.  
(Source: Excerpted in part from the New Orleans Times Picayune)

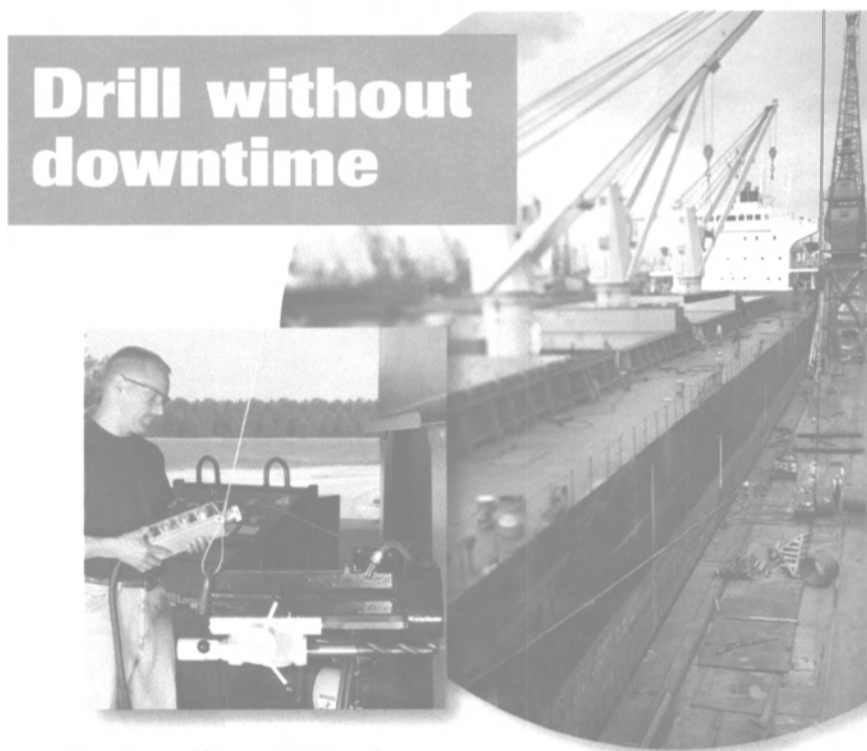

**Drill without  
downtime**

### Hydraulic drill gives you power and portability

Anywhere you need reliable, heavy-duty drilling, count on Lamina. Our powerful hydraulic drill makes a 2-inch hole in seconds, yet is compact and portable... use it in drydock, or even at sea.

Drill or tap in any direction — up, down, or sideways. It's rugged and easy to operate, needs far less maintenance than electric drill equipment, and even works underwater. Some have been in use for 30 years, and our latest model practically eliminates downtime.

Lamina drills meet all applicable standards, in North America and Europe. Five heads are available, with quick-change tools for a range of tasks. Call Anchor Lamina today... and ask about our convenient rent-to-own program.

 **Anchor Lamina Inc.**  
Lamina Hydraulics™

Call toll-free: 1-800-6-LAMINA;  
or visit our website: [www.anchorlamina.com](http://www.anchorlamina.com)

Circle 206 on Reader Service Card or visit [www.maritimereporterinfo.com](http://www.maritimereporterinfo.com)



## KING-GAGE® Marine Systems

### Ballast and Tank Level Indicating Systems for the Marine and Offshore Oil/Gas Industries



**LevelPRO™ Multiple Tank Level Processors**  
LevelPRO provides continuous measurement of ballast levels and shipboard service tanks. Up to 8 tank levels with local display and operator terminal. Digital multidrop network compatible with automated control systems. Durable corrosion-proof housing and sealed keypad.



**LiquiSeal™ Purge Control**  
LiquiSeal Purge Control is a fully integrated level sensor for liquid cargo/service tanks or for draft measurement. External mounting on the tank or at remote location. Rugged brass construction with pneumatic or two wire (4-20 mA) output. Compressed air required for operation.



**LevelBAR™ Replaces Fluid-Filled Gauges**  
LevelBAR offers direct replacement for fluid-filled manometer tank gauges. Built for greater reliability, analog LED column graphically displays tank level. Rugged stainless enclosure and shatterproof window. Models for electronic or air driven systems.

Call 800-242-8871 | Fax 734-662-6652



**KING-GAGE**  
KING ENGINEERING CORPORATION  
3201 S. State • P.O. Box 1228 • Ann Arbor, MI 48106 • 734-662-5691

Circle 253 on Reader Service Card or visit [www.maritimereporterinfo.com](http://www.maritimereporterinfo.com)

70

Maritime Reporter & Engineering News

## Halter Moss Point: This Way is Up

**Bill Skinner ... Sibley Perry ... Eric Richards.**

Respectively the senior vice president of operations, the yard manager, and the NOAA project manager at Halter Moss Point, this trio represents nearly one century of marine industry experience, experience that will be crucial in returning all of Halter Marine to its pre-Chapter 11 form.

"It won't be long and our heads will be held high again, and we will be back to where we were," Richards said. By their own admission, the facility in Moss Point is not particularly large. But it is modern and offers what cannot be bought: a level of ship and boatbuilding experience that earns the highest accolades from the world's most discriminating customers.

### Logistic Support Vessel

One customer who was instrumental in the continuation of operation of Halter Marine — the U.S. Army's Tank and Automotive Command (TACOM) — celebrated the laying of the keel of its new Enhanced Logistic Support Vessel (ELSV) in July. The 314 x 60 x 19 ft. (95.7 x 18.2 x 5.7 m) vessel — when completed in two years — will support TACOM logistical efforts on a worldwide basis. Halter has previously built for the U.S. Army six LSVs, six Large Tugs and 35 LCU-2000 Class Landing Craft Utilities.

"Halter has designed and built all of the U.S. Army's LSVs — this being number seven," said **Anil Raj**, Chief Operating Officer. "Two additional LSV's have been built previously for the Philippine Navy. We value the trust and confidence that the Army has placed in Halter's Team."

The yard also started construction of NOAA's (National Oceanographic and Atmospheric Administration) newest vessel the M/V Oscar Dyson. The \$38.3 million vessel is scheduled for delivery in 36 months. The M/V Oscar Dyson is a state-of-the-art Fishing Research Vessel named in honor of **Oscar Dyson**, of Kodiak, Alaska. Mr. Dyson, a well-known fishing activist served as an industry advisor to government officials, including a congressional delegation.

The vessel will be homeported in Kodiak, Alaska as part of the NOAA fleet. The Office of Marine and Aviation Operations will operate the vessel. The vessel will measure 209 x 49 ft. (63.6 x 15 m), and a draft with the centerboard

in an up position of 19 ft. (5.9 m). The vessels will house multiple laboratories and is designed with a 40-day endurance. In addition to this government work, Halter Marine recently launched Capella, an 80,000-barrel tank barge for J&L, Inc. The barge, the first project Halter has undertaken for J&L, was built at Halter's Gulfport, Miss. Yard. Delivery was scheduled for

August 30. The barge is 332 ft. (101.1 m) long, with a beam of 74 ft. (22.5 m) and a depth of 25 ft. (7.6 m), and is built to U.S. Coast Guard standards under Sub-chapter D, as a tank barge certified to carry Grade A or lower bulk petroleum products. The barge also qualifies to be certified by the American Bureau of Shipping (ABS) under the +A1 Oil Tank Barge designation.

# Progress creates success.

Leading technology from Liebherr.

**LIEBHERR-WERK NENZING GMBH**  
P.O. Box 10, A-6710 Nenzing  
Tel. +43 5525 - 606 - 280  
Fax. +43 5525 - 606 - 448  
deck.crane@lwn.liebherr.com  
www.liebherr.com



# LIEBHERR

The name for cranes.



View of the Moss Point yard from the perspective of **Sibley Perry**, yard manager.

Circle 256 on Reader Service Card or visit [www.maritimereporterinfo.com](http://www.maritimereporterinfo.com)



*“the cost of preventing  
the ingress of  
contamination may  
only be 10 percent  
of what it will  
eventually cost once  
the contamination  
is allowed to enter  
lubricating oils.”*

*- Sunoco's Contamination  
Counter Attack*

*Charles Pitt, Sunoco Chemicals  
Lana Robin, PdMA*

*July/August 2001 Issue  
Practicing Oil Analysis*

## **Oil Safe<sup>®</sup> Lubrication Tools**

**A simple, effective solution to lube contamination.**

**North American Inquiries Call  
Companion Products, Inc.**

**(888) OIL SAFE**

**www.oilsafe.net**

**email [info@oilsafe.net](mailto:info@oilsafe.net)**

Oil Safe<sup>™</sup> is a registered trademark of Oil Safe Systems Pty Ltd

**European Inquiries Call  
Enluse BV (The Netherlands)**

**+31-344-627562**

**Mr. Ian Knight**

**www.enluse.com**

**email [i.knight@planet.nl](mailto:i.knight@planet.nl)**

Oil Safe<sup>®</sup> UAN 563 764 229



**Oil Safe<sup>®</sup>**  
*The Right Tool for the Job*



## Stealthy ROV Keeps Divers Out of Danger

In Port Bustamante, Jamaica last year, three divers inspected the hull of vessels as part of the anti-narcotic procedure were killed to prevent them from investigating and discovering contraband. To cut the threat to divers and their families, Security Administrators Limited invested in VideoRay ROVs to begin diver-less inspections. Operated by one person on the dock or deck of a boat, the eight-lb. ROV (remotely operated vehicle) now inspects vessels sailing from Jamaica to the U.S.



The submersible vehicle, which is connected to a 500-ft. tether, is outfitted with a video camera that relays video from underwater to a monitor. VideoRay used in conjunction with scanning sonar and GPS can quickly and precisely locate and identify plumes of divers or targets. A manipulator arm that can be mounted to the submersible can pick up objects up to of 100 lbs./50kgs. **Steve van Meter**, a Hazardous Duty Robotics Specialist from NASA/Kennedy Space Center, has worked on three missions with the U.S. Customs Contraband Enforcement team at Port Canaveral, Fla., to inspect ships for which the U.S. Customs had intelligence of carrying drugs. In the absence of dive teams to perform the searches, the VideoRay was sent into the bilge areas, the ballast tanks, and then on a complete survey of the bottom of the ship. During his survey of the bottom of the vessel, van Meter was looking for unusual spots and new welds on the barnacle-encrusted surface. He checked the prop shaft and bow thruster for places a package or parasitic devise could be stowed, and was also able to check the entire bottom and verify the propeller shaft condition without ever getting in the water. Van Meter has also worked with the Brevard County and Orange County Sheriff's office dive teams to teach them how to use the VideoRay to search docks, piers, and ships.

Circle 68 on Reader Service Card  
[www.maritimereporterinfo.com](http://www.maritimereporterinfo.com)

## Alstom To Equip LNG With Electric Propulsion Technology

ALSTOM will reportedly be the first company in the world to install electric propulsion technology on a Liquid Natural Gas (LNG) carrier, which is being built at ALSTOM's Chantiers de l'Atlantique shipyard in France for the Gaz de France. The use of this technology on an LNG ship follows the company's successes on other ship types. The LNG ship, with a capacity of 74,000 cu. m., will be delivered to Gaz de France by the end of 2004. It will be propelled through a variable fre-

quency main propulsion system, via a gearbox. The electric drive principally consists of two 9,550 kW, 1,200 rpm synchronous motors, supplied by two synchroconverters associated with a propulsion control and monitoring system.

Circle 5 on Reader Service Card  
[www.maritimereporterinfo.com](http://www.maritimereporterinfo.com)

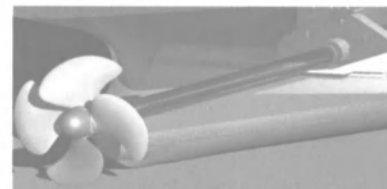



# Willard Marine, Inc.

THE BUILDER YOU CAN DEPEND UPON

1250 N. Grove Street, Anaheim, CA 92806 • 714-666-2150 • Fax 714-632-8136  
 Web site: [willardmarine.com](http://willardmarine.com) • E-mail: [webmaster@willardmarine.com](mailto:webmaster@willardmarine.com)

Founded 1957

**PROPRIETARY DESIGNS & SPECIAL PROJECTS**

**COMMERCIAL** • Revenue producing vessels for the Tourist Trade

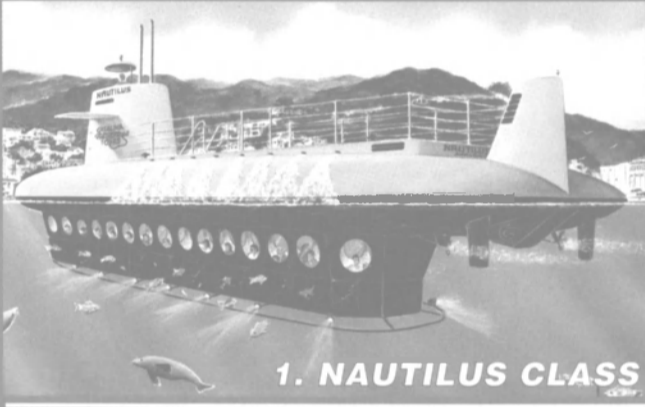

**1. NAUTILUS CLASS**



**2. SEAVIEW**



**3. AQUABUS**

**GOVERNMENT** • More than 800 boats delivered to the U.S. Government



**4. SEPTAR 56\***



**5. KINGSTON 32\***



**6. PERSONNEL BOATS\***

**RIGID INFLATABLES** • U.S.A. Leading Builder of Commercial & Military RIBs



**7. SEA FORCE\***



**8. PATROL RIB\***



**9. SEA FORCE SOLAS\***

\*Willard Marine GSA Contract GS-07F-0123H

1. Nautilus Class 65' x 49 Passenger Semi-Submersible Viewing Vessel  
 2. SeaView 49' x 49 Passenger Viewing Vessel  
 3. Aquabus 40' x 49 Passenger Water Taxi  
 4. Septar 56'/17m Remote Controlled Target Simulator (GSA\*)  
 5. Kingston 32' Patrol RIB (GSA\*)  
 6. Personnel Boat 40'/13m (GSA\*)  
 7. Sea Force 24'/7m U.S. Navy (GSA\*)  
 8. Sea Force 36'/11m Patrol/Utility RIB (GSA\*)  
 9. Sea Force U.S.C.G. SOLAS Approved RIBs (GSA\*)

Circle 344 on Reader Service Card or visit [www.maritimereporterinfo.com](http://www.maritimereporterinfo.com)



**QUALITY**  
**PERFORMANCE**  
**EXPERIENCE**  
**SERVICE**

**mj MI-JACK**™  
PRODUCTS

3111 West 167th Street, Hazel Crest, Illinois USA  
Phone: (708) 596-5200 • Fax: (708) 225-2312  
[www.mi-jack.com](http://www.mi-jack.com)



Circle 145 on Reader Service Card or visit [www.maritimereporterinfo.com](http://www.maritimereporterinfo.com)

# New Center for Fire and Evacuation Safety

Ever since the sinking of the Titanic, experts have occupied themselves with the question of how passengers can be evacuated from a ship in the fastest possible way. Passengers and crew rarely have a chance to prepare themselves for the consequences of a disaster. In this context, ongoing efforts are being made to further the tightening-up of the standards and procedures governing evacuation and safety on board ships. With the opening of a new research and training centre for fire and evacuation safety, Beele Engineering of Aalten (the Netherlands) expects to enhance its capability to contribute towards these efforts.

Going back to the Titanic disaster, the time available for crew and passengers to abandon ship has been significantly extended, among other things by the introduction of smoke and fire detectors as well as sprinkler systems. Even so, time and again it later emerges that in emergency situations there was 'just too little time'. The human panic factor plays a role here. Again and again, it becomes clear that both passengers and crew tend to panic when there is an outbreak of fire or a power failure. As a result of the panic, people take wrong evacuation routes and their sense of disorientation is only heightened. In the case of fire, the dense and suffocating smoke is an additional complicating factor.

In such cases, the significance of luminous EXIT signs and pictograms indicating staircases, evacuation routes and deck plans becomes questionable. How many people will take the time to study the deck plan when they arrive on board an unfamiliar cruise ship? And will persons in a panic be in a fit state to recognize the signs and pictograms, which were developed in peace and quiet on the drawing board?

In the research and training center, all possible attempts are made to find the answers to these questions. At the heart of the new centre lies a demonstration mock-up facility covering approximately 500 sq. m. The facility is so constructed that a variety of practical situations can be simulated in a lifelike way. For instance, it can be used to simulate a ship's cabins and corridors, including raised areas and open spaces. Emergency situations can then be imitated by switching off all the lighting and playing sound recordings.

Under these conditions, the people present in the mock-up facility then have to find their way out. While they do so, the behavior of the test persons and the effectiveness of the evacuation route signposting system are recorded by means of infrared cameras and an audio

system.

The mock-up is divided into two parts: one part is fitted with an evacuation route signposting system, while the other part has no signposting. In this way it can be determined to what extent

the existing signs are effective, and in what respects these may require modification or even new product development. The actions of the 'fleeing' persons can be observed on closed-cir-



cuit TV screens from a control room, which is also used as a showroom. Besides the evacuation research effort,



**B. Hepworth and Co. Ltd.**  
INCORPORATING  
**Hepworth Marine**  
INTERNATIONAL  
**Hepworth Rail**  
INTERNATIONAL

**Dudleys Screenwipers**  
**Hepworth Steel Stockholders**

SUBSIDIARY  
**Window Wiper Technologies Inc.**

**Manufacturers of**  
**Window Wiper Systems**  
Established 1868



- O.E. standard product
- Full design facility
- Technical back-up
- M.O.D. approved supplier
- Installation service available

**Window Wiper Technologies Inc.**  
 800 Flanders Road, Mystic,  
 Connecticut CT06355 USA  
 Tel: 001 860 536 6274 Fax: 001 860 536 9218  
 Email: [hepworthwwt@msn.com](mailto:hepworthwwt@msn.com)  
 Website: [www.b-hepworth.com](http://www.b-hepworth.com)



Circle 240 on Reader Service Card  
 or visit [www.maritimereporterinfo.com](http://www.maritimereporterinfo.com)

Next time you think of steering

## steer to Jastram!



North American Shipbuilding chose Jastram steering when building this 260ft. anchor handling tug and supply vessel.

**Jastram Hydraulic Steering Systems are the ideal choice when designing a new vessel or planning a retrofit.**

**Jastram ENGINEERING LTD.**

467 Mountain Highway  
 North Vancouver, B.C.  
 Canada V7J 2L3  
 Tel: (604) 986-0714  
 Fax: (604) 986-0334  
 Web: [www.jastram.ca](http://www.jastram.ca)  
 e-mail: [marketing@jastram.ca](mailto:marketing@jastram.ca)

Circle 246 on Reader Service Card  
 or visit [www.maritimereporterinfo.com](http://www.maritimereporterinfo.com)

## Are Stray Electrical Currents Destroying Your Machinery?

Used on propeller shafts, thrusters, turbines, generators, electric motors, gears, pumps & other rotating equipment.

-Failure to properly ground rotating shafts can result in bearing, seal and gear damage.

-Operates dry or with oil spray. Self-cleaning.

-Working parts can be removed and serviced during operation.

-Brush voltage is insulated from casing, allowing voltage and current monitoring.

"TOOTHBRUSH" TYPES "LW," "L" & "S" (SCHEMATIC)

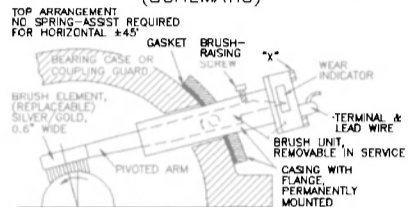

"PLUNGER" TYPE "A" (SCHEMATIC)

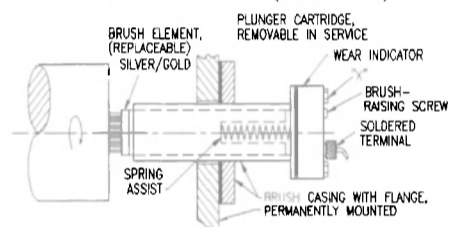

© 2001  
 SOHRE TURBOMACHINERY INC.

## SOHRE TURBOMACHINERY<sup>®</sup> INC.

132 Gilbertville Road, P.O. Box 889 TEL: (413) 967-8908  
 Ware, Massachusetts, USA 01082 FAX: (413) 967-5846  
 (800) 207-2195 [tsohre@sohreturbo.com](mailto:tsohre@sohreturbo.com) [www.sohreturbo.com](http://www.sohreturbo.com)

Circle 293 on Reader Service Card  
 or visit [www.maritimereporterinfo.com](http://www.maritimereporterinfo.com)

## Marine Deck Hardware and Equipment

◆ **ANCHORS** ◆  
 50 to 60,000 Lbs. - New and Used  
 Stockless - Danforth - L.W.T. - Halls - Snug Stowing

◆ **CHAIN** ◆  
 3/4" to 5 1/2" - New and Used  
 Stud Link - Cast Steel - Grades 2 and 3 - Oil Rig Quality for Moorings, Towing, Barge Handling, Ship's Replacement

◆ **WINCHES - WINDLASSES - CAPSTANS** ◆  
 Vertical or Horizontal Hand, Electric, Diesel, Hydraulic or Repowered to your specs

◆ **HATCHES - WATERTIGHT DOORS** ◆  
**MANHOLE COVERS - SCUTLES - PORTHOLES** ◆  
 All Sizes - New or Reconditioned

◆ **PANAMA CHOCKS - DOUBLE BITTS** ◆  
**SINGLE BITTS - CAST STEEL CLEATS AND KEVELS** ◆  
 All Sizes Available, New & Used

◆ **FENDERS FOAM FILLED and PNEUMATIC** ◆  
 For Rent or Sale  
 All Sizes, New & Used

**GIGANTIC INVENTORY**  
 NEW & USED  
 Call Toll-Free (800) 322-3131

**IN STOCK NOW**  
 in the West Coast East Coast and The Gulf

SEVERING THE MARINE & OIL INDUSTRIES FOR OVER 50 YEARS  
 WE ARE DIRECT FACTORY DISTRIBUTORS & IMPORTERS

PO BOX 596  
 WILMINGTON, CA 90748  
 PH: (310) 522-9698  
 FAX: (310) 522-1043

Circle 312 on Reader Service Card  
 or visit [www.maritimereporterinfo.com](http://www.maritimereporterinfo.com)



**KORT NOZZLES  
IN STANDARD  
AND CUSTOM  
CONFIGURATIONS**



**HARRINGTON MARINE**

6720 124TH AVE., FENNVILLE MI 49408  
PHONE 800-962-5000 FAX 616-543-4637

VISIT OUR WEBSITE AT  
<http://www.harringtonmarine.com>

Circle 237 on Reader Service Card  
or visit [www.maritimereporterinfo.com](http://www.maritimereporterinfo.com)

**CAPT. R. J. UNDERHILL  
&  
ASSOCIATES, INC.  
SINCE 1953**

Marine Surveyors, Consultants  
and Expert Witnesses  
World Wide Service  
Western Gulf Reps for ICGB  
P.O. Box 1030  
Groves, Texas 77619  
Phone: (877) 985-9329  
Fax: (409) 985-8320  
[www.underhill-surveyors.com](http://www.underhill-surveyors.com)

Circle 217 on Reader Service Card  
or visit [www.maritimereporterinfo.com](http://www.maritimereporterinfo.com)

the center also acts as the headquarters for the general R&D effort of Beele Engineering. For this purpose a total area of 300 sq. m. is reserved for three laboratories in which light emission investigations, large-scale fire tests and mechanical tests are performed. The fire tests are intended to make it possible to examine the behavior during fire of various materials that are used in shipping. In addition, investigations are carried out into how fire is able to spread in a short time, and what measures can and must be taken in order to contain that spread. The light emission laboratory concentrates in particular on research into the effectiveness of luminescent evacuation route signs (pictograms etc.) in a wide range of lighting conditions.

The center is open not only to people who are professionally involved with fire, fire prevention and evacuation safety (firefighting personnel, safety professionals, surveyors, shipping authorities, etc.) but also to other interested people. For that purpose the center also contains a presentation theatre seating up to 45 persons.

Next year, Beele Engineering will have been engaged in the field of passive fire prevention for 30 years. The company's product range include the Yfestos range of products that glow in the dark, which was nominated for the category 'Best safety innovation' of the Cruise & Ferry Award.

In addition, the company supplies a versatile and comprehensive range of fire resistant, water-gas- and smoke-tight sealing systems for cable and pipe conduits. In the event of an outbreak of fire, these systems ensure as far as possible that the fire is contained and prevented from spreading.

Circle 63 on Reader Service Card  
[www.maritimereporterinfo.com](http://www.maritimereporterinfo.com)

Don't risk engine security, maintenance economy and proven peace of mind: Specify CHOCKFAST ORANGE.

**Chockfast  
ORANGE**

is the chocking compound approved by every major classification society, including ABS

ITW Philadelphia Resins



130 Commerce Drive, Montgomeryville, PA 18936  
Tel 215.855.8450 Fax 215.855.4688 [www.chockfast.com](http://www.chockfast.com)

Circle 277 on Reader Service Card or visit [www.maritimereporterinfo.com](http://www.maritimereporterinfo.com)



**All-American Qualities**

SeaArk Marine has provided our Armed Forces with strong, dependable, durable aluminum patrol boats for over 40 years. SeaArk patrol boats are available in sizes from 17' to 65'.

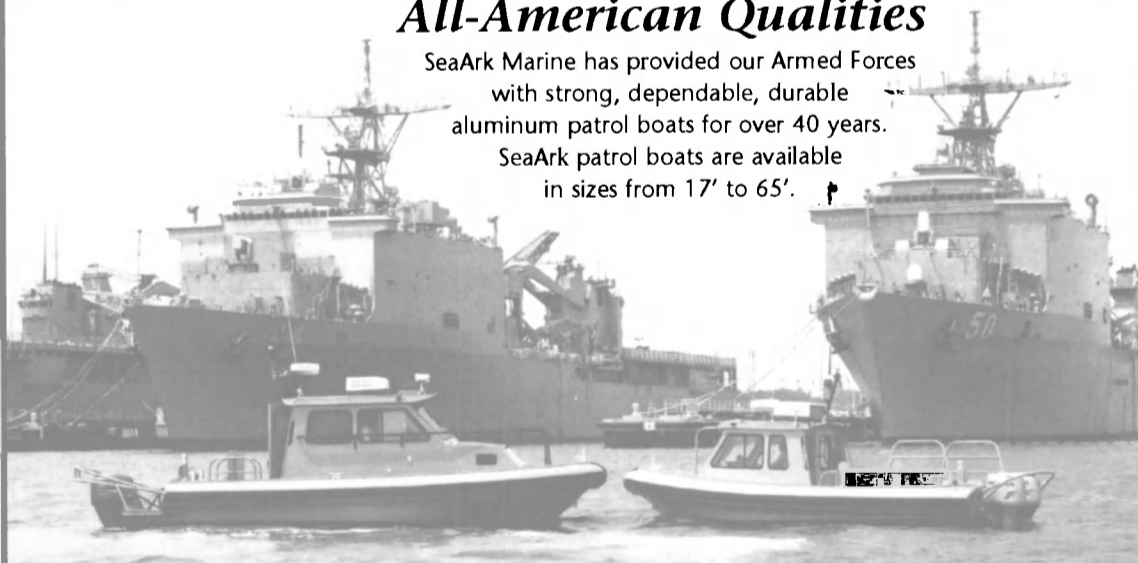

**QUALITY BOATS BUILT FOR WHAT YOU DO!**

SeaArk Marine's 28' Dauntless "RAM" and 27' Commander "RAM" have been selected to defend our Nation's harbors and coastlines by the United States Navy.



**SEAARK  
MARINE**

P.O. Box 210  
Monticello, AR, USA 71657  
Phone: (870) 367-9755 • Fax: (870) 367-2120  
[www.seaark.com](http://www.seaark.com)



All Boats Are Available On GSA Contract

Circle 327 on Reader Service Card or visit [www.maritimereporterinfo.com](http://www.maritimereporterinfo.com)



**CALHOON MEBA  
ENGINEERING SCHOOL**

**Providing state-of-the-art  
Training to the  
Marine Engineers and Deck  
Officers  
of the MEBA**



MEBA MARINE OFFICERS  
DEDICATED TO PRIDE,  
EXCELLENCE AND SERVICE  
SINCE 1875

Over 25 courses including: STCW,  
Steam, Diesel, Gas Turbine Propulsion,  
Refrigeration  
Tankship Safety, Electronics, and Instrumentation

27050 St. Michaels Road  
Easton, MD 21601  
(410) 822-9600  
(410) 822-7220 (Fax)

Joyce H. Matthews, Director  
E-mail: [mebaschool@mebaschool.org](mailto:mebaschool@mebaschool.org)  
Website: [www.mebaschool.org](http://www.mebaschool.org)



"Providing Knowledge, Not Just a License"

Circle 347 on Reader Service Card  
or visit [www.maritimereporterinfo.com](http://www.maritimereporterinfo.com)

## KMSS Receive Greek Type Approval For MBB

Kongsberg Maritime Ship Systems (KMSS) has received type approval from the Greek authorities for its Maritime Black Box (MBB) Voyage Data Recorder.

Designed and tested to IMO and SOLAS standards, the Protected Storage Unit can withstand an extreme amount of stress, while the Data Control Unit (DCU) operates the entire system.

In addition to the main units, KMSS also offer a Replay and Evaluation Unit (REU) that utilizes the data collected by the PSU and DCU for training purposes. It gives users a hands on view of how real-life situations should be dealt with and can also be used for other applications such as Radar and ECDIS image distribution, voyage reports, engine logs and the back-up of information to CD-Rom.

Circle 41 on Reader Service Card  
www.maritimereporterinfo.com

## L-3 Communications Acquires Ross

L-3 Communications has acquired substantially all of the assets of Ross Engineering, thus integrating the Ross product lines into the L-3 Communications' Aviation Recorders Division.

With operations headquartered in Sarasota, Fla., L-3 Communications Aviation Recorders will be leveraging Ross Engineering's experience in marine communications, and couple it with L-3's financial, engineering, manufacturing, and marketing resources. This will allow L-3 to become a major supplier of Universal Automatic Identification Systems (UAIS) and Digital Selective Calling (DSC) VHF radios to the maritime

Circle 232 on Reader Service Card or visit [www.maritimereporterinfo.com](http://www.maritimereporterinfo.com)

# ANCHORS CHAINS

industry. This acquisition will also enable L-3 to extend its product portfolio into other new product areas within the maritime industry.

## Lockheed Martin Renames Maritime Business

Lockheed Martin has re-named its Marine Traffic Management business to better reflect its capabilities in the areas of marine navigation, coastal and harbor surveillance and homeland security. The business, based in Syracuse, N.Y., now will be known as Maritime Safety, Security and Surveillance (MS3).

## Technip-Coflexip Sells McNulty Yard

Technip-Coflexip has signed a Sales and Purchase Agreement related to the sale of its affiliates McNulty Offshore Ltd. and Captain Frank McNulty & Sons Ltd., to the Managing Director of McNulty Offshore Ltd. Technip-Coflexip had a 90 percent stake in both companies following the purchase of Aker Deepwater Company in January 2001.

# WORTELBOER



Tel.: +31 (0)10 429 2222  
Fax: +31 (0)10 429 6459

According to the terms of this agreement, Technip-Coflexip has sold the Newcastle-based yard, together with all activities and resources dedicated to it, to McNulty's Managing Director. The transaction, the amount of which is undisclosed, is in line with Technip-Coflexip's previously announced program to dispose of non-strategic assets.

Circle 3 on Reader Service Card  
www.maritimereporterinfo.com

In Business Since 1972

**NautiCAN** MADE in CANADA

**Achieve Top Performance with NautiCAN High Efficiency Nozzles with Pre-swirl Stators**



*Dunlap Towing new Tug Phyllis Dunlap, designed by Fisker-Andersen & Whalen, Inc., recorded unprecedented ABS certified bollard pull of 167,600 lbs using NautiCAN Nozzles with Pre-Swirl Stators, NautiCAN*

*Propellers and NautiCAN High Aspect rator Triple Rudders*

*Western Titan—NautiCAN HE Nozzles with stators on Ulstein Z-drives for superior efficiency, towing speed and bollard pull, followed by Pacific Titan and Gulf Titan*



*CIS Agile—shows remarkable 2.0 knots increase in Speed and Efficiency after installing NautiCAN High Efficiency Nozzles.*



Since 1972, NautiCAN has been developing leading edge innovations in Hydrodynamics, Naval Architecture and Computing. Today we have the highest efficiency technology to suit your needs, whether you need to save on fuel costs, increase speed or increase manoeuvrability.

NautiCAN Research & Development Ltd.  
Phone: 604-921-1920 Fax: 604-921-1925  
email: [josip@nautican.com](mailto:josip@nautican.com) www.nautican.com



P.O. Box 698  
757 Nichols Ave  
Fairhope, AL 36533  
1-251-928-1234  
Phone/Fax

MARINE EXHAUST SYSTEMS OF ALABAMA INC.

Mesamarine@Earthlink.net <http://www.mesamarine.com>

Water Cooled Manifolds, Heat Exchangers, Collector Risers, Mufflers, and Custom Fabrication for Caterpillar, Cummins, Onan, Detroit, Perkins, Waukesha, Westerbeke, Hercules, Mack, Isuzu, John Deere, Kubota, Daewoo, Isotta Fraschini, Ford, Palmer, International, Fairbanks Morse, Lister, Wisconsin, and more. Marineization, Repair, and Duplication of Obsolete Parts available upon request.



Please Contact us for all of your exhaust needs.

Circle 260 on Reader Service Card  
or visit [www.maritimereporterinfo.com](http://www.maritimereporterinfo.com)

[www.marinesigns.com](http://www.marinesigns.com)

**Marine & Offshore Signage Experts**

We have the capabilities to supply ALL your signage needs, including complete shipboard conversion projects and sign upgrading services.

**NOW... Order online**

or contact us for your FREE CD Product Guide and see our new product lines!







Maritime Associates  
P.O. Box 1788 • Crystal Bay, NV 89402 USA  
775-832-2422 • Fax: 775-832-2424  
E-mail: [maritimeas@aol.com](mailto:maritimeas@aol.com)

Circle 262 on Reader Service Card  
or visit [www.maritimereporterinfo.com](http://www.maritimereporterinfo.com)

Hunting for a new job?

Set your sights on the extensive listings on

**Maritime Jobs ONLINE**

[www.maritimejobs.com](http://www.maritimejobs.com)

The ideal environment to bag your next job.

THE MARITIME GROUP  
118 East 25th Street, New York, NY 10010  
Tel: 212 477 6700, Fax: 212 254 6271, E-mail: [info@maritimeink.com](mailto:info@maritimeink.com)

**TRACTOR PINS FOR TODAY'S TUGS**

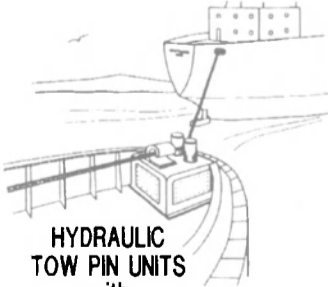

HYDRAULIC TOW PIN UNITS with HOLD-DOWN HOOK

**WESTERN MACHINE WORKS**

1870 Harbour Road - North Vancouver, B. C. - Canada - V7H 1A1  
Phone: (604) 929-7901 Fax: (604) 929-7951 or (604) 929-5329

Circle 313 on Reader Service Card  
or visit [www.maritimereporterinfo.com](http://www.maritimereporterinfo.com)

Circle 343 on Reader Service Card  
or visit [www.maritimereporterinfo.com](http://www.maritimereporterinfo.com)

# U.S. Market: Foundation for the Future

In part two of a two-part series, William G. Schubert, the new U.S. Maritime Administrator (MarAd), speaks with H. Clayton Cook, Jr. about the current standing and future direction of maritime activities in the United States.

**Cook:** I'd like to pick up where we left off last time. You were explaining where matters stood concerning MarAd's monitoring the time chartering of U.S.-flag vessels by foreign nationals.

Let me say a few words for the benefit of our readers. As you and I both understand, the Shipping Act, 1916, requires that MarAd approve all transfers of U.S.-flag vessels, or interests in these vessels, to non-citizens. Time charters are such a transfer of interest, and time charters to foreign nationals require MarAd approval. Over the years since 1916, and until 1992, MarAd required the submission of such time charters for MarAd review prior to MarAd approval. With certain limited exceptions, this submission for review was eliminated in 1992 as a part of the Administration's deregulation efforts. And, MarAd issued a so-called "advance general approval" of all such charters. So, at the present time a foreign national can time charter a U.S.-flag vessel without MarAd's knowledge or any specific approval.

I see that MarAd has published the Federal Register Notice that you mentioned at our last meeting. The Notice reviews the history of the 1992 changes and states that any MarAd change in policy will require a further MarAd rulemaking proceeding. Would you comment?

**Schubert:** As I've said before, the world is a different place today from what it was in 1992. A time charterer determines what cargoes will be loaded and discharged and directs the vessel's schedules and its ports of call. A U.S.-flag vessel chartered to an unknown foreign national could present problems. The vessel is a U.S.-flag vessel, so one might assume that it doesn't pose any risks. But the foreign national could direct that the vessel be loaded in a fashion and directed to a location where there is the possibility of mischief. And, this could occur without the vessel's U.S. citizen master and crew being fully aware of what was going on.

You will forgive me if I don't comment further. As a first step we wish to obtain the industry's advice concerning what might be involved if MarAd returned to a case-by-case review. We will be receiving industry comments in response to our Federal Register Notice. We will review these comments, and discuss these matters with the Coast Guard and other concerned agencies, and go from there.

## OPA '90 TANKERS

**Cook:** When we closed last time you were beginning to speak about your commitment to work with the Navy, our U.S. shipbuilding and repair yards, labor, our U.S. commercial vessel operators, and Congress to develop a unified long-term strategy to maintain our shipyard capacity. Could we pick up on that?

**Schubert:** Yes. MarAd needs to address the issues of U.S. shipyard productivity, modern shipyard infrastructure, R & D investment, and training of a sufficient number of skilled workers. I want to work with our U.S. shipyards in identifying opportunities in our domestic trade, and in then turning these opportunities into successful projects. Everyone agrees that our shipyards need to identify vessel designs that they can build in series in order to achieve adequate economies of scale. The Kvaerner Philadelphia Shipyard may be headed in that direction with its container vessel design. I believe this can be done in meeting our needs for Oil Pollution Act of 1990 (OPA 90) product tankers and with other vessel designs.

**Cook:** There has been a good deal of discussion concerning a "short fall" of tankers sufficient to meet OPA 90 needs. How would you define the "short fall" problem? What can MarAd do to assist in solving the problem?

**Schubert:** The General Accounting Office's Year 2000 report on OPA 90 compliance recommended that MarAd monitor the progress being made to replace single-hull vessels with double-hull vessels, and keep the relevant House and Senate Committees advised of the progress being evidenced in meeting OPA 90 requirements. MarAd issued a report on this subject "U.S. Tank Vessel Markets, Impact of OPA-90 Double Hull Requirements," this past June.

The report is available to interested parties on line at [www.marad.dot.gov/statistics](http://www.marad.dot.gov/statistics), so I won't go into all of the detail here.<sup>1</sup> Briefly, however, in performing the required analyses, it is necessary to break the industry down into four sections: domestic crude carriers, domestic product tankers, coastal tank barges, and foreign flag tankers serving our U.S. product import trades.

The Alaska crude oil trades are the primary source of demand for the U.S. crude carriers. The oil companies involved in Alaska production have undertaken the OPA 90 responsibility here. At the close of 2001 there were eight new double hull crude carriers on order with more than enough capacity to meet OPA 90 year 2005 requirements. So we can rest easy on this aspect of OPA 90 compliance.

The OPA 90 problem, which is the subject of widespread concern, is the apparent short fall in U.S.-flag product tankers. These vessels are engaged the historic U.S. Gulf Coast to north of Hatteras, and in Florida and West Coast trades, and in movements on the West Coast itself. These trades have been declining in recent years and will continue to decline.

The shorter runs in these trades became the province of tug tank barge services some years ago. More recently, with increases tank barge productivity, and the introduction of articulated tug barge combinations with larger barges, there has been some substitution of



these barges for product tankers on the longer runs as well. So this factor must be considered.

Age and OPA 90 resulted in the removal of 38 product tankers from the domestic trades from 1994 to 2000. I expect the removal of another 12 vessels by the end of 2005. We have had 11 newly built or reconstructed double-hull product tankers delivered over the period 1996 to 1999 at prices which have not exceeded \$40 to \$45 million per vessel. There are eight CDS-built product tankers that will become eligible when they become 20 years of age. However, when all is said and done, we appear to be short U.S.-flag tonnage. But, for our U.S. vessel operators, the "problem" that arises in our current situation is the substitution of foreign products for domestic products once U.S.-flag transportation costs reach a certain level.

You see, the U.S. also obtains a portion of its petroleum product needs through product imports. Virtually all of these product imports are carried by foreign-flag tankers. As of the end of 2000, 83 percent of the worldwide foreign-flag tanker fleet was eligible to for U.S. trades. Between now and the end of 2005 over 34 million DWT of existing foreign-flag capacity will become ineligible by OPA 90 standards. However, current new buildings and those, which we project, appear sufficient to more than offset this reduction.

Further, looking back at the year 2000, only about 51 percent of the foreign-flag tanker fleet eligible for U.S. trades actually served U.S. trades. So, there is a substantial pool of existing world tonnage that can move into the U.S. trades. Once the differential between foreign-flag rates and U.S.-flag rates reaches a certain point, for example, the delivered cost of imported petroleum products in the Northeast becomes less than the delivered cost of domestic petroleum products transported from our Gulf Coast refineries to the Northeast.

The U.S. operators appear to be fine shape in terms of achieving the daily rates necessary for the profitable employment of the existing U.S.-flag vessels, which cost no more than \$40 million to \$50 million. However, with the U.S. shipyards now speaking in terms of vessel prices in the \$80 million to \$100 million range, U.S. operators will need a market, which will support \$40,000 to \$50,000 in daily hire, if they are to employ these vessels profitably. This market may not exist, largely because the substitution of foreign for domestic products that I have just explained.

Pictured in the Background: The launching of M.V. Midnight Sun, the first commercial dry cargo vessel to built in the U.S. occurred last month at NASSCO in San Diego, Calif.

<sup>1</sup> General Accounting Office, "Maritime Industry: As U.S. Single-Hull Oil Vessels Are Eliminated, Few Double-Hull Vessels May Replace Them," GAO/RCED-00-80, April 28, 2000, p. 21.

<sup>2</sup> Interested parties may also obtain copies of the MarAd report by contacting MarAd's Office of Statistical and Economic Analysis, William B. Ebersold, Director, at 202 366 2267.

## KMSS Receive Greek Type Approval For MBB

Kongsberg Maritime Ship Systems (KMSS) has received type approval from the Greek authorities for its Maritime Black Box (MBB) Voyage Data Recorder.

Designed and tested to IMO and SOLAS standards, the Protected Storage Unit can withstand an extreme amount of stress, while the Data Control Unit (DCU) operates the entire system.

In addition to the main units, KMSS also offer a Replay and Evaluation Unit (REU) that utilizes the data collected by the PSU and DCU for training purposes. It gives users a hands on view of how real-life situations should be dealt with and can also be used for other applications such as Radar and ECDIS image distribution, voyage reports, engine logs and the back-up of information to CD-Rom.

Circle 41 on Reader Service Card  
www.maritimereporterinfo.com

## L-3 Communications Acquires Ross

L-3 Communications has acquired substantially all of the assets of Ross Engineering, thus integrating the Ross product lines into the L-3 Communications' Aviation Recorders Division.

With operations headquartered in Sarasota, Fla., L-3 Communications Aviation Recorders will be leveraging Ross Engineering's experience in marine communications, and couple it with L-3's financial, engineering, manufacturing, and marketing resources. This will allow L-3 to become a major supplier of Universal Automatic Identification Systems (UAIS) and Digital Selective Calling (DSC) VHF radios to the maritime

Circle 232 on Reader Service Card or visit www.maritimereporterinfo.com

# ANCHORS CHAINS

## WORTELBOER

industry. This acquisition will also enable L-3 to extend its product portfolio into other new product areas within the maritime industry.

## Lockheed Martin Renames Maritime Business

Lockheed Martin has re-named its Marine Traffic Management business to better reflect its capabilities in the areas of marine navigation, coastal and harbor surveillance and homeland security. The business, based in Syracuse, N.Y., now will be known as Maritime Safety, Security and Surveillance (MS3).

## Technip-Coflexip Sells McNulty Yard

Technip-Coflexip has signed a Sales and Purchase Agreement related to the sale of its affiliates McNulty Offshore Ltd. and Captain Frank McNulty & Sons Ltd., to the Managing Director of McNulty Offshore Ltd. Technip-Coflexip had a 90 percent stake in both companies following the purchase of Aker Deepwater Company in January 2001.

Tel.: +31 (0)10 429 2222  
Fax: +31 (0)10 429 6459  
gjw@wortelboer.nl  
www.wortelboer.nl

According to the terms of this agreement, Technip-Coflexip has sold the Newcastle-based yard, together with all activities and resources dedicated to it, to McNulty's Managing Director. The transaction, the amount of which is undisclosed, is in line with Technip-Coflexip's previously announced program to dispose of non-strategic assets.

Circle 3 on Reader Service Card  
www.maritimereporterinfo.com

In Business Since 1972

**NautiCAN** MADE in CANADA

Achieve Top Performance with NautiCAN High Efficiency Nozzles with Pre-swirl Stators

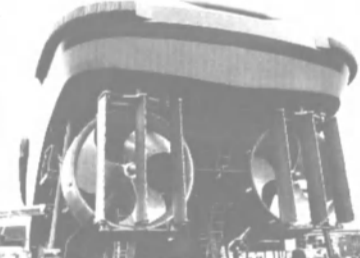

Dunlap Towing new Tug Phyllis Dunlap, designed by Fisker-Andersen & Whalen, Inc., recorded unprecedented ABS certified bollard pull of 167,600 lbs using NautiCAN Nozzles with Pre-Swirl Stators, NautiCAN

Propellers and NautiCAN High Aspect ratio Triple Rudders

Western Titan—NautiCAN HE Nozzles with stators on Ulstein Z-drives for superior efficiency, towing speed and bollard pull, followed by Pacific Titan and Gulf Titan



C/S Agile—shows remarkable 2.0 knots increase in Speed and Efficiency after installing NautiCAN High Efficiency Nozzles.



Since 1972, NautiCAN has been developing leading edge innovations in Hydrodynamics, Naval Architecture and Computing. Today we have the highest efficiency technology to suit your needs, whether you need to save on fuel costs, increase speed or increase manoeuvrability.

NautiCAN Research & Development Ltd.  
Phone: 604-921-1920 Fax: 604-921-1925  
email: josip@nautican.com www.nautican.com

Circle 343 on Reader Service Card  
or visit www.maritimereporterinfo.com

P.O. Box 698  
757 Nichols Ave  
Fairhope, AL 36533  
1-251-928-1234  
Phone/Fax

MARINE EXHAUST SYSTEMS OF ALABAMA INC.

Mesamarine@Earthlink.net http://www.mesamarine.com

Water Cooled Manifolds, Heat Exchangers, Collector Risers, Mufflers, and Custom Fabrication for Caterpillar, Cummins, Onan, Detroit, Perkins, Waukesha, Westerbeke, Hercules, Mack, Isuzu, John Deere, Kubota, Daewoo, Isotta Fraschini, Ford, Palmer, International, Fairbanks Morse, Lister, Wisconsin, and more. Marinization, Repair, and Duplication of Obsolete Parts available upon request.



Please Contact us for all of your exhaust needs.

Circle 260 on Reader Service Card  
or visit www.maritimereporterinfo.com

www.marinesigns.com

Marine & Offshore Signage Experts

We have the capabilities to supply ALL your signage needs, including complete shipboard conversion projects and sign upgrading services.

NOW... Order online

or contact us for your FREE CD Product Guide and see our new product lines!



Maritime Associates  
PO Box 1788 • Crystal Bay, NV 89402 USA  
775-832-2422 • Fax: 775-832-2424  
E-mail: maritimeas@aol.com

Circle 262 on Reader Service Card  
or visit www.maritimereporterinfo.com

Hunting for a new job?  
Set your sights on the extensive listings on

Maritime Jobs

www.maritimejobs.com

The ideal environment to bag your next job.

THE MARITIME GROUP  
118 East 25th Street, New York, NY 10010  
Tel: 212-477-6700, Fax: 212-254-6271, E-mail: info@marinelink.com

TRACTOR PINS FOR TODAY'S TUGS

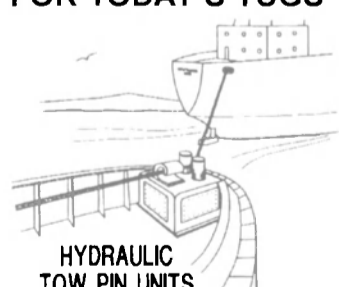

HYDRAULIC TOW PIN UNITS with HOLD-DOWN HOOK

WESTERN MACHINE WORKS

1870 Harbour Road - North Vancouver, B. C. - Canada - V7H 1A1  
Phone: (604) 929-7901 Fax: (604) 929-7951 or (604) 929-5329

Circle 313 on Reader Service Card  
or visit www.maritimereporterinfo.com

# U.S. Market: Foundation for the Future

In part two of a two-part series, William G. Schubert, the new U.S. Maritime Administrator (MarAd), speaks with H. Clayton Cook, Jr. about the current standing and future direction of maritime activities in the United States.

**Cook:** I'd like to pick up where we left off last time. You were explaining where matters stood concerning MarAd's monitoring the time chartering of U.S.-flag vessels by foreign nationals.

Let me say a few words for the benefit of our readers. As you and I both understand, the Shipping Act, 1916, requires that MarAd approve all transfers of U.S.-flag vessels, or interests in these vessels, to non-citizens. Time charters are such a transfer of interest, and time charters to foreign nationals require MarAd approval. Over the years since 1916, and until 1992, MarAd required the submission of such time charters for MarAd review prior to MarAd approval. With certain limited exceptions, this submission for review was eliminated in 1992 as a part of the Administration's deregulation efforts. And, MarAd issued a so-called "advance general approval" of all such charters. So, at the present time a foreign national can time charter a U.S.-flag vessel without MarAd's knowledge or any specific approval.

I see that MarAd has published the Federal Register Notice that you mentioned at our last meeting. The Notice reviews the history of the 1992 changes and states that any MarAd change in policy will require a further MarAd rulemaking proceeding. Would you comment?

**Schubert:** As I've said before, the world is a different place today from what it was in 1992. A time charterer determines what cargoes will be loaded and discharged and directs the vessel's schedules and its ports of call. A U.S.-flag vessel chartered to an unknown foreign national could present problems. The vessel is a U.S.-flag vessel, so one might assume that it doesn't pose any risks. But the foreign national could direct that the vessel be loaded in a fashion and directed to a location where there is the possibility of mischief. And, this could occur without the vessel's U.S. citizen master and crew being fully aware of what was going on.

You will forgive me if I don't comment further. As a first step we wish to obtain the industry's advice concerning what might be involved if MarAd returned to a case-by-case review. We will be receiving industry comments in response to our Federal Register Notice. We will review these comments, and discuss these matters with the Coast Guard and other concerned agencies, and go from there.

## OPA '90 TANKERS

**Cook:** When we closed last time you were beginning to speak about your commitment to work with the Navy, our U.S. shipbuilding and repair yards, labor, our U.S. commercial vessel operators, and Congress to develop a unified long-term strategy to maintain our shipyard capacity. Could we pick up on that?

**Schubert:** Yes. MarAd needs to address the issues of U.S. shipyard productivity, modern shipyard infrastructure, R & D investment, and training of a sufficient number of skilled workers. I want to work with our U.S. shipyards in identifying opportunities in our domestic trade, and in then turning these opportunities into successful projects. Everyone agrees that our shipyards need to identify vessel designs that they can build in series in order to achieve adequate economies of scale. The Kvaerner Philadelphia Shipyard may be headed in that direction with its container vessel design. I believe this can be done in meeting our needs for Oil Pollution Act of 1990 (OPA 90) product tankers and with other vessel designs.

**Cook:** There has been a good deal of discussion concerning a "short fall" of tankers sufficient to meet OPA 90 needs. How would you define the "short fall" problem? What can MarAd do to assist in solving the problem?

**Schubert:** The General Accounting Office's Year 2000 report on OPA 90 compliance recommended that MarAd monitor the progress being made to replace single-hull vessels with double-hull vessels, and keep the relevant House and Senate Committees advised of the progress being evidenced in meeting OPA 90 requirements.<sup>1</sup> MarAd issued a report on this subject "U.S. Tank Vessel Markets, Impact of OPA-90 Double Hull Requirements," this past June.

The report is available to interested parties on line at [www.marad.dot.gov/statistics](http://www.marad.dot.gov/statistics), so I won't go into all of the detail here.<sup>2</sup> Briefly, however, in performing the required analyses, it is necessary to break the industry down into four sections: domestic crude carriers, domestic product tankers, coastal tank barges, and foreign flag tankers serving our U.S. product import trades.

The Alaska crude oil trades are the primary source of demand for the U.S. crude carriers. The oil companies involved in Alaska production have undertaken the OPA 90 responsibility here. At the close of 2001 there were eight new double hull crude carriers on order with more than enough capacity to meet OPA 90 year 2005 requirements. So we can rest easy on this aspect of OPA 90 compliance.

The OPA 90 problem, which is the subject of widespread concern, is the apparent short fall in U.S.-flag product tankers. These vessels are engaged the historic U.S. Gulf Coast to north of Hatteras, and in Florida and West Coast trades, and in movements on the West Coast itself. These trades have been declining in recent years and will continue to decline.

The shorter runs in these trades became the province of tug tank barge services some years ago. More recently, with increases tank barge productivity, and the introduction of articulated tug barge combinations with larger barges, there has been some substitution of



these barges for product tankers on the longer runs as well. So this factor must be considered.

Age and OPA 90 resulted in the removal of 38 product tankers from the domestic trades from 1994 to 2000. I expect the removal of another 12 vessels by the end of 2005. We have had 11 newly built or reconstructed double-hull product tankers delivered over the period 1996 to 1999 at prices which have not exceeded \$40 to \$45 million per vessel. There are eight CDS-built product tankers that will become eligible when they become 20 years of age. However, when all is said and done, we appear to be short U.S.-flag tonnage. But, for our U.S. vessel operators, the "problem" that arises in our current situation is the substitution of foreign products for domestic products once U.S.-flag transportation costs reach a certain level.

You see, the U.S. also obtains a portion of its petroleum product needs through product imports. Virtually all of these product imports are carried by foreign-flag tankers. As of the end of 2000, 83 percent of the worldwide foreign-flag tanker fleet was eligible to for U.S. trades. Between now and the end of 2005 over 34 million DWT of existing foreign-flag capacity will become ineligible by OPA 90 standards. However, current new buildings and those, which we project, appear sufficient to more than offset this reduction.

Further, looking back at the year 2000, only about 51 percent of the foreign-flag tanker fleet eligible for U.S. trades actually served U.S. trades. So, there is a substantial pool of existing world tonnage that can move into the U.S. trades. Once the differential between foreign-flag rates and U.S.-flag rates reaches a certain point, for example, the delivered cost of imported petroleum products in the Northeast becomes less than the delivered cost of domestic petroleum products transported from our Gulf Coast refineries to the Northeast.

The U.S. operators appear to be fine shape in terms of achieving the daily rates necessary for the profitable employment of the existing U.S.-flag vessels, which cost no more than \$40 million to \$50 million. However, with the U.S. shipyards now speaking in terms of vessel prices in the \$80 million to \$100 million range, U.S. operators will need a market, which will support \$40,000 to \$50,000 in daily hire, if they are to employ these vessels profitably. This market may not exist, largely because the substitution of foreign for domestic products that I have just explained.

**Pictured in the Background:** The launching of M.V. *Midnight Sun*, the first commercial dry cargo vessel to built in the U.S. occurred last month at NASSCO in San Diego, Calif.

<sup>1</sup> General Accounting Office, "Maritime Industry: As U.S. Single-Hull Oil Vessels Are Eliminated, Few Double-Hull Vessels May Replace Them," GAO/RCED-00-80, April 28, 2000, p. 21.

<sup>2</sup> Interested parties may also obtain copies of the MarAd report by contacting MarAd's Office of Statistical and Economic Analysis, William B. Ebersold, Director, at 202 366 2267.





# Plastic Pilings Inc.

STRENGTH & INNOVATION



## Out With The Old

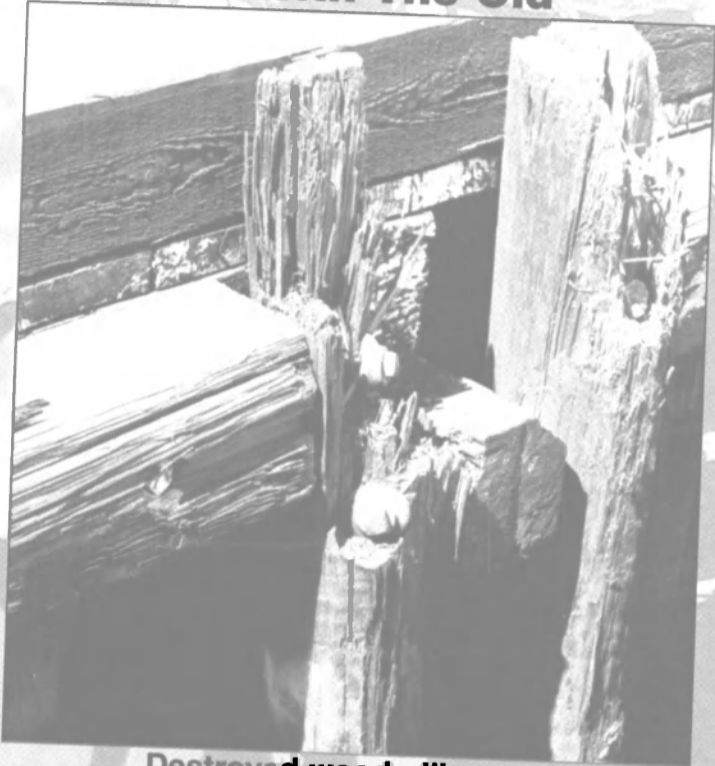

**Destroyed wood pilings**

## In With The New



**Maintenance free plastic pilings**



**Corroded steel fender panel**



**Corrosion resistant plastic fender panel**

**SUPERIOR MARINE PRODUCTS MADE FROM 100% RECYCLED PLASTIC SINCE 1905**

Plastic Pilings, Inc. 1485 S. Willow Ave. Rialto, CA 92376 USA 909-874-4080 Fax 909-874-4860 [www.plasticpilings.com](http://www.plasticpilings.com)

Circle 279 on Reader Service Card or visit [www.maritimereporterinfo.com](http://www.maritimereporterinfo.com)

# Pound For Pound, Ballast-Crete Is Better

For All Marine Fixed Ballast Operations  
Densities Up To 400 pcf (S.G. 6.4)

Inorganic, removable, and available in a wide range of densities, Ballast-Crete is the ballast of choice for naval architects and engineers around the world. For more information, call Redland Genstar at (410) 683-9254.  
email: bobchester@lafarge-na.com



**BALLAST-CRETE**

**Redland**  
GENSTAR

Circle 280 on Reader Service Card  
or visit [www.maritimereporterinfo.com](http://www.maritimereporterinfo.com)

## MARINE PROPULSION PARTS & PRODUCTS

### KAPLAN & ASSOCIATES, INC

Seal Kits	New & Used
Gear Sets	Thrusters
Overhaul Kits	Prop Shafts
"Hard to find Parts"	Marine Equipment

TOLL FREE  
1.877.SEND SPARES (1.877.736.3772)

Parts Available 7 Days a Week- 24 Hours a Day- Visa/Mastercard  
Harbormaster-Murray & Tregurtha-Sykes-Schottel-Jastram-Others

24 Hour Hotline: 248.788.8989  
Tel: 248.788.8161 Fax: 248.788.8162  
Email: [alankaplan@aol.com](mailto:alankaplan@aol.com)  
Web Site: <http://www.alkaplan.com>

Circle 250 on Reader Service Card  
or visit [www.maritimereporterinfo.com](http://www.maritimereporterinfo.com)

## Be More Productive!

Now you can paint pipes 10x FASTER  
with our patented roller!

Special Offer \$10.95  
\* \$5 s&h



- Paints standard 2"-3" pipes.
- 4 individual rollers with dense poly nap, nylon core & sturdy metal frame.
- Plant Engineering "Product of the Year".

Money Back Guarantee! Please allow 1 week for delivery.

800-862-3290 ext.66

[www.pipepainter.com](http://www.pipepainter.com)

Circle 278 on Reader Service Card  
or visit [www.maritimereporterinfo.com](http://www.maritimereporterinfo.com)

**Cook:** That is a fairly large daily hire cost burden to overcome. What role can MarAd play in assisting the U.S.-flag operators as they seek to solve this problem?

**Schubert:** Perhaps MarAd can be a useful intermediary. We need to see what can be done to reduce the U.S. operator's costs to a level where they generate daily rates that the market will sustain. You can look at the daily rate as composed of vessel operating cost and vessel capital cost components. There is not much that we can achieve in reductions in operating costs.

So, we must focus on the capital cost component. This can be broken into two parts, the cost of the vessel and the cost of financing the vessel.

We need to address shipyard prices and financing costs. The starting point for the first issue might be a standard product tanker design that could be built in series by one or more U.S. shipyards. I am planning meetings on this subject, first with U.S.-flag operators to gage their sense of the market and their thoughts about a standard design, next with potentially interested shipbuilders, and finally with petroleum company users, and with the U.S. Navy which may itself be in need of this size tanker.

Next we need to focus on sources for equity and debt to facilitate lower cost financing. The Office of Management and Budget (OMB) has advised MarAd that it will have no objection to our renewing our capital construction fund (CCF) proposals this fall as we go into the 2004 budget cycle. There is almost \$1.4 billion of U.S. citizen shipowner money on deposit there. The owners have already set this money aside for shipbuilding. Much of this money might be available for use as equity for product tanker construction.

This could be used in combination with borrowings from whatever financing sources will be available at that time. The important point to understand is that these financing costs may be almost as important as the shipyard price in the daily rate computation.

**Cook:** That is an ambitious program for action. I might like to deal a bit further with the subject of the

## FREE LIFEBOAT & DAVITS INSPECTION

In Singapore only, please call (65) 266 1412

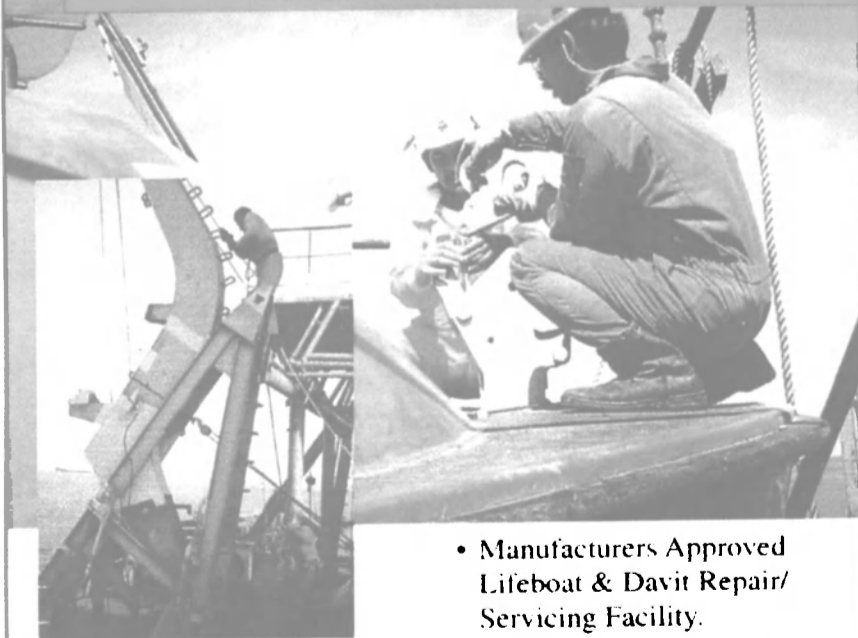

- Manufacturers Approved Lifeboat & Davit Repair/ Servicing Facility.
- Sales of Reconditioned/ New Lifeboats & Davits.
- Services also available in Malaysia, Philippines, Dubai, India, Sri Lanka, Sweden, Indonesia, Shanghai and Honolulu (USA).



**Techno Fibre (S) Pte Ltd**  
51 Shipyard Road, Singapore 628139  
Tel: (65) 266 1412 Fax: (65) 266 1435  
email: [lifeboat@technofibre.com](mailto:lifeboat@technofibre.com)  
Web site: <http://www.technofibre.com>



Circle 320 on Reader Service Card or visit [www.maritimereporterinfo.com](http://www.maritimereporterinfo.com)

# INNOVATION NOT IMITATION

THE NEW **REVERSE DOUBLE-LOOP FENDERS**  
"Patented for Your Protection"

**1-800-426-3917**

16901 Wood-Red Rd. • Woodinville, WA 98072  
(425) 488-2255 • FAX (425) 488-2424

[www.schuylerrubber.com](http://www.schuylerrubber.com) • email: [sales@schuylerrubber.com](mailto:sales@schuylerrubber.com)



**We Innovate, Others Just Imitate**

Circle 287 on Reader Service Card or visit [www.maritimereporterinfo.com](http://www.maritimereporterinfo.com)

sources for vessel debt financing, but let's move on. What is your time table?

**Schubert:** I expect to have completed the first of these meetings, with the U.S.-flag operators, this month. These meetings will have been accomplished before your subscribers will read

about them in this interview. We will follow on from there and establish an appropriate schedule and time lines.

**Coastwise Trailer Movements**

**Cook:** In your March 14th FY 2003 authorization testimony you spoke about the traffic congestion problems that the

U.S. is facing, and about Coastwise shipping as one means of dealing with the problem. Would you explain the problem as you see it?

**Schubert:** The most highway traffic congested section of the United States is our Northeast Corridor. These

13 states and the District of Columbia contain 27 percent of entire U.S. population. Population density is comparable to that of the fifteen countries in the European Union. New Jersey's exceeds that of the EU's most densely populated country The Netherlands.

Your readers who have driven Inter-

ILS Marine ILS Marine ILS Marine ILS Marine ILS Marine ILS Marine ILS Marine ILS Marine ILS Marine ILS Marine

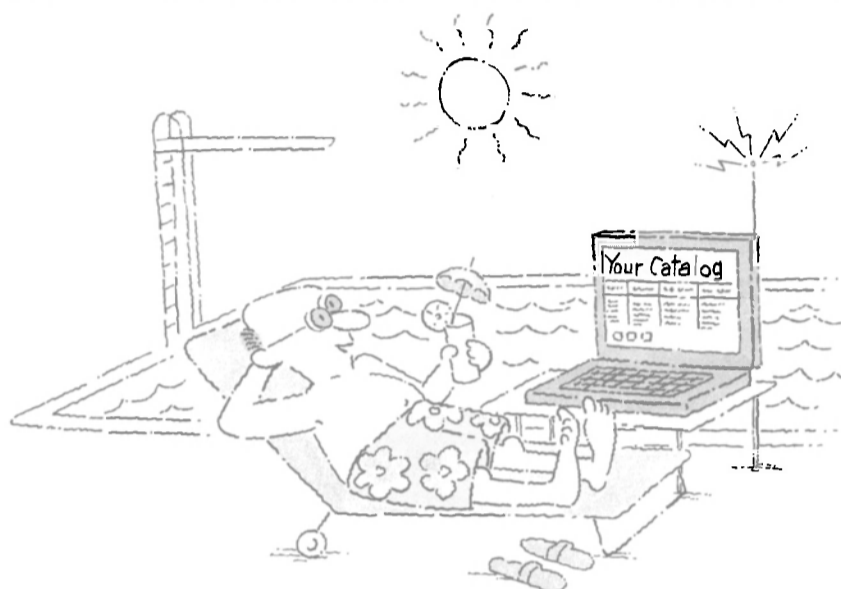

**Your Products. Your Catalog. On-Line. No Headaches.**

**T**he ILS Quick Catalogue takes the worry out of selling on-line. It helps your customers and prospects find what they need on your site, and lets them send quote requests directly to you. Your company can increase sales without adding overhead. ILS Quick Catalogue frees your sales personnel from just taking orders and lets them spend more time selling. It frees you from the deadlines and expense of paper catalogs and improves your customer support by providing fast, accurate information and eliminating mistakes. Polish your company's image as an innovator with ILS Quick Catalogue.

**Your new sales workhorse.** The ILS Quick Catalogue is totally accessible from your Internet site. It is customized to look like part of your site, but it is actually hosted on ILS state-of-the-art servers.

Visitors to your site click on a catalog link that takes them instantly to your ILS Quick Catalogue. Using our powerful search facility, they can locate the items they need and send you a request for quote. You can easily update your ILS Quick Catalogue from your site to eliminate out of stock items or add new ones.

**With 99.9% uptime, you profit from our vast experience.** If you are considering developing your own e-catalog, consider this: ILS has been bringing buyers and sellers together electronically since before the advent of the personal computer. Our uptime for 2001 was virtually 100%. We've been rated "Best of the B2B Web" by *Forbes* magazine, two years in a row.

**Industrial strength services.** Your ILS Quick Catalogue receives the same care and

attention that we give our own award-winning world class e-marketplace:

- 24/7 customer support.
- Redundant servers.
- Full disaster recovery plan.
- Leading edge technology.
- Highly skilled technicians and designers on staff.

**It's not all about technology.** At ILS, we've been offering e-commerce solutions for the marine industry for more than a decade. When you call ILS, you will talk to real people with the experience and know-how to transform your site into a profit center. There's never been an easier, more cost effective way to take the pain of development and the agony of maintenance out of your life. For more information go to [www.ILSmart.com](http://www.ILSmart.com), or contact us today.



Inventory Locator Service,® LLC  
3965 Mendenhall Road, Memphis TN, 38115  
Phone: 1-901-794-5000 • Fax: 1-901-794-1760  
email: [ebusiness@ILSmart.com](mailto:ebusiness@ILSmart.com)

ILS Marine ILS Marine ILS Marine ILS Marine ILS Marine ILS Marine ILS Marine ILS Marine ILS Marine ILS Marine

Circle 348 on Reader Service Card or visit [www.maritimereporterinfo.com](http://www.maritimereporterinfo.com)

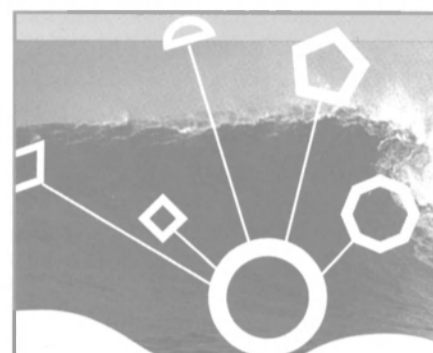

**ElectroWave**  
makes integration easy.

**BALLAST CONTROL & MONITORING SYSTEM**  
 ■ Fully Automatic Ballast Control System (optional)  
 ■ Works with all types of tank level sensors and indicators

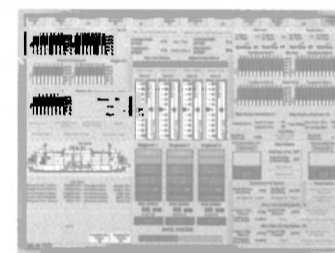

**MARINE MACHINERY PLANT CONTROL & MONITORING SYSTEMS**  
 ■ Bilges & Ballast, Ship Systems, Lube Oil, Fire, Fuel Oil, Engine & Generators, Vessel LAN, Propulsion, Sea Water, Ship Service, Alarms...

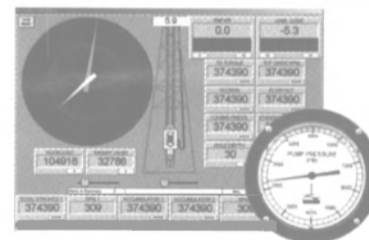

**ELECTRONIC & STANDARD DRILLING INSTRUMENTATION**  
 ■ ElectroWave MudSys™ and DriiSys™ Stand-alone or fully integrated electronic systems  
 ■ Standard Pneumatic / Hydraulic gauges

**ELECTROWAVE** is also proud to represent and market the following:

**TMS, LevelCom™**  
Tank Level Indication System

**ROLLOOS / ORLACO CCTV**  
Camera • Monitor Systems

**ElectroWave**

**INSTALLED AND SUPPORTED EQUIPMENT**  
 Mediterranean Sea • South China Sea • Arabian Sea  
 Gulf of Guinea • South Atlantic • North Sea • North Atlantic  
 Gulf of Mexico • Barents Sea • Indian Ocean • Bay of Bengal  
 Baltic Sea • Upper New York Bay and the Great Lakes

Call 713-896-7799 or visit our website: [www.electrowaveusa.com](http://www.electrowaveusa.com)  
 6125 W. Sam Houston Pkwy N., Ste. 406  
 Houston, Texas 77041

Circle 328 on Reader Service Card or visit [www.maritimereporterinfo.com](http://www.maritimereporterinfo.com)

## U.S. Report

state 95 are aware of the problem today. But, matters are going to get much worse. Current studies predict a doubling of freight traffic by 2010 and a tripling by 2030. Looking at 2010, these studies indicate that, after taking into account rail freight service expansions, we are going to be adding 10,000 more trucks to I-95 per day — which is the equivalent of adding one more truck every 270 yards from Maine to Florida. Let me add that similar problems exist in the I-5 and I-10 corridors.

Do you know that it typically costs about \$32 million to add a single mile of four lane interstate highway, and about \$100 million per interchange? This does not include the cost of land acquisition. So, it's clear that we can't build out of the problem with additional highway construction.

**Cook:** What can be done?

**Schubert:** For the I-95 corridor the obvious answer is water transportation. These water routes are existing "highways" that are almost entirely unused. These water highways, I believe that you have called them "W-95s," can be placed in service with only the modest costs of roadstead and terminal construction, and of the vessels involved. These W-95 highways do not

require regular maintenance and periodic resurfacing. Further, FHWA advises us that if we can reroute a substantial portion of the heavy trailers in this fashion we will reduce the costs of highway and bridge maintenance.

**Cook:** A moment ago you mentioned the European Union. You have recently come back from a trip to the EU where you were looking at their use of water transport. Can you say a word about that?

**Schubert:** Yes, in contrast to our situation, in Europe today 40 percent of the freight moved within the EU is moved by water. Further, the EU has an ambitious "motorways of the sea" initiative designed to increase the share of water borne carriage between EU members. The Europeans have focused on the lower environmental and social costs of waterborne transportation of freight as important elements in EU strategic planning. I believe that these benefits are fairly obvious, and that the Europeans are on the right track.

Much of the attention on this subject has been focused on the transport of sea containers coming into the U.S. at a port like Port Newark and then being transferred up or down the Coast. Actually, the more important problem on I-95 is

with the purely domestic moves in the large 53 foot trailers. Taking these 53 footers off of I-95, and off the metropolitan bypasses like I-495, would do a great deal to alleviate congestion and the reduce the potential for accidents. Air quality would be a major benefactor. Trailers with hazardous materials transported in this fashion would be removed from bridge and tunnel transit as well as bypassing major metropolitan centers.

**Cook:** How do you get this started?

**Schubert:** First, we need to work within DOT with the Federal Highway Administration (FHWA) and the Office of the Assistant Secretary for Transportation Policy (OST Policy), and then work with the Administration, to make Coastwise shipping a part of our national transportation system planning. For example, we are exploring opportunities for the inclusion of the water mode in Tea 21, and its inclusion in the six year surface transportation authorization bill that is now being considered by Congress. We are working with FHWA and OST Policy, and with the Administration, on these issues.

MarAd and FHWA are working developing critical cargo data statistics in freight movements within the United States which will illustrate the viability of

Coastal shipping markets. This information will be provided to the National Ports and Waterways Institute (NPWI) for use in the fourth and final phase of their study of the East, Gulf and West Coasts. This study will identify location pairs and cargo volumes where water transportation can be most easily introduced. We expect the results of this NPWI study to be available in late 2002 or early 2003.

MarAd and FHWA are planning a conference on Coastal "short sea" shipping in New York City for this November. We expect conference participation from across the spectrum of those concerned. The conference will explore the dynamics of a robust U.S. Coastal shipping system, the job and entrepreneurial opportunities that such a system would offer participants, and the benefits that would accrue to everyone in the reduction of highway congestion and improvements in air quality.

We expect this conference to bring the most interested stakeholders together. The objective will be to identify Coastwise shipping opportunities, and terminal, roadstead and vessel designs, and to discuss problems and solutions; the "how" of developing successful Coastwise systems.

We hope to achieve a consensus, which will provide the support neces-

## LIMITLESS CONNECTIVITY



## BEYOND THE HORIZON™

Our mobile and fixed remote communications solutions will keep you connected well beyond the reach of terrestrial communications. Stratos offers you Inmarsat, MSAT, Iridium, VSAT, and Globalstar services so you can stay connected. Our customers benefit from digital voice, fax, dispatch, data, and ISDN services. At Stratos, we accept no limits. Neither should you.

Contact us regarding: **New Lower Inmarsat Rates / Specialized Data Solutions / Iridium Maritime Promotions**

Toll Free: +1 888 766 1313

Worldwide: +1 709 748 4233

saleseast@stratosglobal.com

www.stratosglobal.com

**STRATOS**

Circle 297 on Reader Service Card or visit [www.maritimereporterinfo.com](http://www.maritimereporterinfo.com)

**UNITED STATES BANKRUPTCY COURT  
SOUTHERN DISTRICT OF NEW YORK**

**In re** : Chapter 11 Case Nos.  
**BETHLEHEM STEEL CORPORATION, et al.** : 01-15288 (BRL) through 01-15302, 01-15308 through 01-15315 (BRL)  
**Debtors.** : (Jointly Administered)

**NOTICE OF BAR DATE REQUIRING FILING OF PROOFS OF CLAIM  
ON OR BEFORE SEPTEMBER 30, 2002 AT 5:00 P.M. (EASTERN TIME)**

TO ALL PERSONS AND ENTITIES WITH CLAIMS AGAINST ANY OF THE DEBTOR ENTITIES LISTED IN THE ANNEXED SCHEDULE A:

PLEASE TAKE NOTICE THAT on July 31, 2002, the United States Bankruptcy Court for the Southern District of New York (the "Court") having jurisdiction over the chapter 11 cases of the debtor entities listed in the annexed schedule A (collectively, the "Debtors") entered an order (the "Bar Date Order") establishing **September 30, 2002, at 5:00 p.m. (Eastern Time)** (the "Bar Date"), as the last date and time for each person or entity (including, without limitation, each individual, partnership, joint venture, corporation, estate, trust, and governmental unit) to file a proof of claim against any of the Debtors. The Bar Date Order and the Bar Date, as well as the procedures set forth below for the filing of proofs of claim, apply to the claims described below against the Debtors that arose prior to October 15, 2001, the date on which each of the Debtors commenced a case under chapter 11 of title 11, United States Code (the "Bankruptcy Code").

**1. WHO MUST FILE A PROOF OF CLAIM**

You **MUST** file a proof of claim to share in the estate if you have a claim that arose prior to October 15, 2001, and it is not one of the types of claims described in section 2 below. Acts or omissions of the Debtors that arose before October 15, 2001, may give rise to claims against the Debtors notwithstanding that such claims may not have matured or become fixed or liquidated prior to such date.

Under section 101(5) of the Bankruptcy Code and as used herein, the word "claim" means: (a) a right to payment, whether or not such right is reduced to judgment, liquidated, unliquidated, fixed, contingent, matured, unmatured, disputed, undisputed, legal, equitable, secured, or unsecured; or (b) a right to an equitable remedy for breach of performance if such breach gives rise to a right to payment, whether or not such right to an equitable remedy is reduced to judgment, fixed, contingent, matured, unmatured, disputed, undisputed, secured, or unsecured.

**2. WHO NEED NOT FILE A PROOF OF CLAIM**

You need not file a proof of claim if:

- You have **already** properly filed, with the Clerk of the United States Bankruptcy Court for the Southern District of New York, a proof of claim against the applicable Debtor or Debtors utilizing a claim form which substantially conforms to the Proof of Claim form tailored for these cases or Official Form No. 10;
- Your claim is listed on the Debtors' Schedules (as defined below) and is **not** described as "disputed," "contingent," or "unliquidated," **and** your claim is asserted against a specific Debtor, and you do **not** dispute the specific Debtor against which your claim is asserted, and you do **not** dispute the amount or nature of your claim in each case as identified in the upper right-hand corner of the enclosed Proof of Claim. Creditors holding claims which are listed in the Schedules without reference to a particular Debtor shall be required to file a Proof of Claim. Annexed hereto as Schedule B is a list of the names under which the Debtors conduct or previously conducted business within the previous six years, the names of associated Debtors, and their respective case numbers;
- Your only claim is under sections 503(b) or 507(a)(1) of the Bankruptcy Code as an administrative expense of any of the Debtors' chapter 11 cases;
- Your claim has already been paid or otherwise satisfied in full by any of the Debtors;
- You are a Debtor and you have a claim against another Debtor;
- You hold a claim that has been allowed by an order of the Court entered on or before the Bar Date;
- You are a present or former employee of one of the Debtors or, with respect to benefits claims, any spouse or beneficiary thereof (**Note:** a separate Bar Date will be established at a later date for the assertion of claims by present and former employees and, with respect to benefits claims, their spouses and beneficiaries); or
- Your claim is limited exclusively to the repayment of principal, interest, and/or other applicable fees and charges (a "Debt Claim") on or under any bond or note issued by the Debtors pursuant to an indenture qualified under the Trust Indenture Act of 1939 (the "Debt Instruments"); *provided, however,* that (i) the foregoing exclusion in this subparagraph shall not apply to the Indenture Trustee under the applicable indenture (the "Indenture Trustee"), (ii) each Indenture Trustee shall be required to file one proof of claim, on account of all of the Debt Claims on or under the applicable Debt Instruments on or before the Bar Date, and (iii) any holder of a Debt Claim wishing to assert a claim, other than a Debt Claim, arising out of or relating to a Debt Instrument shall be required to file a proof of claim on or before the Bar Date, unless another exception in this paragraph applies.

**YOU SHOULD NOT FILE A PROOF OF CLAIM IF YOU DO NOT HAVE A CLAIM AGAINST THE DEBTORS, OR IF THE CLAIM YOU HELD AGAINST THE DEBTORS HAS BEEN PAID IN FULL, RELEASED OR WAIVED.**

**THE FACT THAT YOU HAVE RECEIVED THIS NOTICE DOES NOT MEAN THAT YOU HAVE A CLAIM OR THAT THE DEBTORS OR THE COURT BELIEVE THAT YOU HAVE A CLAIM.**

**3. EXECUTORY CONTRACTS AND UNEXPIRED LEASES**

Any person or entity that has or may have a claim arising from the rejection of an executory contract or unexpired lease as to which the order authorizing such rejection is dated on or before July 31, 2002, the date of the Bar Date Order, must file a proof of claim based on such rejection on or before the Bar Date to share in the estate. Any person or entity that has or may have a claim arising from the rejection of an executory contract or unexpired lease as to which the order authorizing such rejection is dated after the date of the Bar Date Order must file a proof of claim on or before such date as the Court may fix in the applicable order authorizing rejection of such contract or lease.

**4. WHEN AND WHERE TO FILE**

Except as provided for herein, all proofs of claim must be filed so as to be received on or before September 30, 2002 at 5:00 p.m. (Eastern Time), at the following address:

<b>IF SENT BY MAIL</b>	<b>IF SENT BY MESSENGER OR OVERNIGHT COURIER</b>
United States Bankruptcy Court Southern District of New York Bethlehem Steel Claims Processing P.O. Box 5043 Bowling Green Station New York, New York 10274-5043	United States Bankruptcy Court Southern District of New York Bethlehem Steel Claims Processing One Bowling Green New York, New York 10004-1408

(together, the "Bethlehem Steel Docketing Center").

Proofs of claim will be deemed timely filed only if **actually received** by the Bethlehem Steel Docketing Center on or before the Bar Date. Proofs of claim may **not** be delivered by facsimile, teletype transmission, or electronic mail transmission.

**5. WHAT TO FILE**

If you file a proof of claim, your filed proof of claim must (i) be written in English, (ii) be denominated in lawful currency of the United States, (iii) conform substantially with the enclosed proof of claim

or Official Form No. 10, (iv) indicate the Debtor against which you are asserting a claim, and (v) be signed by the claimant, or if the claimant is not an individual, by an authorized agent of the claimant. **YOU SHOULD ATTACH TO YOUR COMPLETED PROOF OF CLAIM FORM COPIES OF ANY WRITINGS UPON WHICH SUCH CLAIM IS BASED, IF VOLUMINOUS, ATTACH A SUMMARY.**

**EXCEPT WITH RESPECT TO CLAIMS OF THE TYPE SET FORTH IN SECTION 2 AND THE SECOND SENTENCE OF SECTION 3 ABOVE, ANY CREDITOR WHO FAILS TO FILE A PROOF OF CLAIM ON OR BEFORE THE BAR DATE OF SEPTEMBER 30, 2002, FOR ANY CLAIM SUCH CREDITOR HAS OR MAY HAVE OR WISHES TO ASSERT AGAINST ANY OF THE DEBTORS WILL BE FOREVER BARRED, ESTOPPED, AND ENJOINED FROM ASSERTING SUCH CLAIM (OR FILING A PROOF OF CLAIM WITH RESPECT TO SUCH CLAIM) AGAINST SUCH DEBTOR, AND SUCH DEBTOR, ITS ESTATE, AND ITS PROPERTY WILL BE FOREVER DISCHARGED FROM ANY AND ALL INDEBTEDNESS OR LIABILITY WITH RESPECT TO SUCH CLAIM, AND SUCH HOLDER SHALL NOT BE PERMITTED TO VOTE ON ANY CHAPTER 11 PLAN OR PARTICIPATE IN ANY DISTRIBUTION IN SUCH DEBTOR'S CHAPTER 11 CASE ON ACCOUNT OF SUCH CLAIM, OR TO RECEIVE FURTHER NOTICES REGARDING SUCH CLAIM.**

**6. THE DEBTORS' SCHEDULES AND ACCESS THERETO**

You may be listed as the holder of a claim against one or more of the Debtors in the Debtors' Schedules of Assets and Liabilities (collectively, the "Schedules"). To determine if and how you are listed on the Schedules, please refer to the descriptions set forth in the upper right hand corner of the enclosed proof of claim form(s) regarding the nature, amount, and status of your claim(s). If you received postpetition payments from the Debtors on account of your claim(s), the enclosed proof of claim form(s) will reflect the net amount of your claim(s) (i.e., reduced by the postpetition payments), as and to the extent such net amount is listed in the Schedules. If the Debtors believe that you hold claims against more than one Debtor, you will receive multiple proofs of claim forms, each of which will reflect the nature and amount of your claim against each such Debtor, as listed in the Schedules. **As noted above, if you agree with the nature, amount, and status of your claim(s) as described in the enclosed proof of claim form(s), and you do not dispute the Debtor identified on the Proof of Claim against which your claim is asserted, you do not need to file a proof of claim. However, if you intend to file one or more proofs of claim, you must do so before the Bar Date in accordance with the procedures set forth in this Notice.**

Copies of the Schedules may be examined by interested parties on the Court's electronic docket for the Debtors' chapter 11 cases, which is posted on the Internet at [www.nysb.uscourts.gov](http://www.nysb.uscourts.gov) (a PACER login and password are required). Copies of the Schedules may also be examined by interested parties between the hours of 9:00 a.m. and 4:00 p.m., Eastern Time, at the office of the Clerk of the Bankruptcy Court, United States Bankruptcy Court for the Southern District, One Bowling Green, Room 511, New York, New York 10004-1408.

**The Bethlehem Steel Docketing Center may be contacted at 1-888-498-7764 if there are questions concerning the filing, amount, nature, or processing of a proof of claim.**

**A CLAIMANT SHOULD CONSULT AN ATTORNEY REGARDING ANY OTHER INQUIRIES, SUCH AS WHETHER THE CLAIMANT SHOULD FILE A PROOF OF CLAIM.**

DATED: July 31, 2002  
New York, New York Harvey R. Miller (HM 6078)  
Jeffrey L. Tanenbaum (JT 9797)  
George A. Davis (GD2761)  
**WEIL, GOTSHAL & MANGES LLP**  
767 Fifth Avenue  
New York, New York 10153  
(212) 310-8000  
**ATTORNEYS FOR THE DEBTORS  
AND DEBTORS IN POSSESSION**

**SCHEDULE A  
LIST OF DEBTOR ENTITIES**

<b>Name of Debtor</b>	<b>Case Number</b>
Bethlehem Steel Corporation	01-15288 (BRL)
Alliance Coatings Company, LLC	01-15289 (BRL)
BethEnergy Mines Inc.	01-15290 (BRL)
Bethlehem Cold Rolled Corporation	01-15291 (BRL)
Bethlehem Development Corporation	01-15292 (BRL)
Bethlehem Rail Corporation	01-15293 (BRL)
Bethlehem Steel de Mexico, S.A. de C.V.	01-15294 (BRL)
Bethlehem Steel Export Company of Canada, Limited	01-15295 (BRL)
Bethlehem Steel Export Corporation	01-15296 (BRL)
BethPlan Corporation	01-15297 (BRL)
Chicago Cold Rolling, L.L.C.	01-15298 (BRL)
Eagle Nest Inc.	01-15299 (BRL)
Encoat-North Arlington, Inc.	01-15300 (BRL)
Energy Coatings Company	01-15301 (BRL)
Greenwood Mining Corporation	01-15302 (BRL)
HPM Corporation	01-15308 (BRL)
Kenacre Land Corporation	01-15309 (BRL)
LI Service Company	01-15310 (BRL)
Marmoraton Mining Company, Ltd.	01-15311 (BRL)
Mississippi Coatings Limited Corporation	01-15312 (BRL)
Mississippi Coatings Line Corporation	01-15313 (BRL)
Ohio Steel Services Company, LLC	01-15314 (BRL)
Primeacre Land Corporation	01-15315 (BRL)

**SCHEDULE B**

**All Other Names Used By the Debtor and its Debtor Affiliates in the Last 6 Years**

Bethcon	L-S II Electro-Galvanizing Company
BethForge Division	LGI
Bethlehem Plant Coke Oven Division	Lukens, Inc.
Bethlehem-Lukens Plate Division	Lukens Steel Company
Bethlehem Works	PST
Brandywine Security Company	Pennsylvania Steel Technologies Division
Burns Harbor Division	Sparrows Point Division
Burns Harbor Galvanized Products Division	Structural Products Division
CENTEC	Washington Plant/Stainless Steel Division
Chesapeake Energy Services, Inc.	Washington Specialty Metals, Inc.
Galvanized Products Division	Washington Specialty Metals Corporation
EGL Steel Inc.	
Lackawanna Coke Division	
Lackawanna Galvanized Division	
LI Flex Force	

## U.S. Report

### Need anti-sweat protection? No problem.

**Delta T Marine**  
holds the following  
approvals & registrations:

U.S. Coast Guard  
A.B.S.  
D.N.V.  
UL Listed  
Lloyd's Registered

NO  
HARMFUL  
VOC's

Manufacturer's  
Representatives Wanted

**Delta  
Coatings**  
www.deltacoat.com

This revolutionary one-part coating system provides the combination of both excellent thermal & anti-condensation protection in an easy to spray, cost effective method.

Most shipyards see a 30%-50% reduction in total applied costs, if installed by yard personnel.

A 20-60 mil layer achieves an equivalency of RvE of 9-14.



Mascoat  
Products

Phone: (713) 465-0304

Fax: (713) 465-0302

Email:

Sales@deltacoat.com

Circle 263 on Reader Service Card or visit [www.maritimereporterinfo.com](http://www.maritimereporterinfo.com)

### Concerned About Safety?

## FILL THE GAPS IN YOUR RADAR.

"NEW! Thermal Infrared Technology!"

See In Complete Darkness  
Avoid Nighttime Collisions  
Watch for Floating Debris & Markers  
Designed for Salt Water Use  
No Illuminators Required  
Easy Installation on Most Boats



Pan/Tilt Thermal Cameras  
Joy-Stick Operation

ARION  
INTERNATIONAL

[www.arion-international.com](http://www.arion-international.com)

(800) 365-7443 (407) 568-9767

Fax: (407) 568-9872

Circle 208 on Reader Service Card or visit [www.maritimereporterinfo.com](http://www.maritimereporterinfo.com)

### NOTICE TO PROPOSERS ADVERTISEMENT

#### CITY OF BOSTON

#### BOSTON FIRE DEPARTMENT

**FOR THE PERFORMANCE OF THE FOLLOWING SERVICES: TO PROVIDE ALL DESIGN, LABOR, MATERIAL, EQUIPMENT, PARTS AND FACILITIES TO CONSTRUCT AND DELIVER ONE (1) FIRE AND RESCUE VESSEL WITH A MAXIMUM LENGTH OF EIGHTY (80) FEET.**

The City of Boston (the City), acting by its Fire Commissioner (The Official), invites proposals from interested and highly qualified parties (Offerors) to perform the services generally described above, and particularly set forth in the Request For Proposals.

All proposals shall be submitted in strict conformance with the Request for Proposals (RFP) which may be obtained at Boston Fire Department Headquarters, Office of the Executive Assistant, 115 Southamptton Street, Boston, MA, 02118. The documents are also available to be mailed by calling (617) 343-3630. RFP documents may be obtained commencing at 10 A.M. on Monday, August 26, 2002 and will be available to all interested parties who present a \$50 certified, treasurer's or cashier's check payable to the City of Boston for each set. RFP's must be returned in good condition within thirty days of the bid opening in order for the bidder to have the \$50 check returned. A preproposal meeting is scheduled for 10 A.M. on September 25, 2002 at the same location. Proposals shall be accepted until 12 o'clock Noon on Friday, October 25, 2002 at the same location.

The RFP sets forth both price and non-price evaluation criteria. Price proposals shall be submitted in a separate sealed envelope and must be priced in strict conformance with the instructions set forth in the RFP.

**FAILURE TO SUBMIT CLEARLY MARKED SEPARATE SEALED PRICE AND NON-PRICE PROPOSALS SHALL RESULT IN DISQUALIFICATION OF THE ENTIRE PROPOSAL.**

A refundable proposal deposit in the amount of a \$2,000 certified, treasurer's or cashier's check is required from each offeror and shall accompany the non-price proposal when submitted to the City.

The maximum time for selection of a proposal is 120 days after the deadline for submission of proposals.

The Official shall not open the proposal publicly, but shall open the Non-Price Proposals in the presence of one or more witnesses within 24 hours of the above deadline for submission of proposals. The Official may open the Price Proposals at a later time and in any case shall open the Price Proposals so as to avoid disclosure to the individuals evaluating the Non-Price Proposals.

The award of this contract shall be subject to the approval of the Mayor of Boston.

Paul A. Christian  
Fire Commissioner

sary for a coordinated program to develop commercially viable Coastal shipping routes to serve the East, Gulf and West Coasts.

**Cook:** What sorts of financing are available to get these Coastal short sea systems underway? Will the conference address the financing aspects of these systems?

**Schubert:** Yes, conference speakers will address the financing aspects. One of the most important financing sources for terminal and roadstead construction in non-attainment areas is Congestion Mitigation Air Quality (CMAQ) money. Most East Coast locations will qualify for CMAQ help, as will some locations on the Gulf and West Coasts. However, these projects will have to "get in line" behind existing highway projects, and the timing may be a problem. There are other sources as well.

**Cook:** What about financing for the vessels?

**Schubert:** We are exploring various alternatives. As I mentioned earlier, OMB has advised us that it will have no objection to our renewing our CCF program requests this fall. There is almost \$1.4 billion of U.S. citizen shipowner CCF money on deposit already set aside for shipbuilding. Some of this money might be available as equity. This could be used in combination with borrowings from whatever financing sources are available at that time.

**Cook:** I'm pleased with your advice on these CCF program requests. But I'm not necessarily encouraged by what you are saying about sources for debt. In transactions in which I have been involved, the debt portion of the financing has often been the most difficult problem. But let's move on to our next topic.

A consulting firm advising a Connecticut port city in planning a Coastal waterborne barge service has told me that they do not believe these Coastal services can be successful so long as the Harbor Maintenance Tax (HMT) is applied to the moves. This group's study concludes that a container movement from Port Newark to the Connecticut port city could be done by sea without any deterioration in delivery time, and at a lower cost than by truck. But, it then concludes, that the estimated cost of the HMT makes the movement by barge more expensive than the movement by truck. They use as an example a 40 foot sea container containing manufactured products with a value of \$176,000. They say that the tax on this single container would amount to \$220.

**Schubert:** I can't speak to your specific example. However, MarAd has studied the HMT issue. It is a serious issue. Of course, movements to and from Alaska, Hawaii and Puerto Rico are exempted. But movements between other states are not. The HMT issue is one that MarAd and FHWA will have to examine more closely as we develop our models for commercially viable Coastal shipping routes.

#### Passenger Ferry Projects

**Cook:** Let's turn to the subject of ferries. In your March 14th FY 2003 authorization testimony you spoke about the congestion problems faced by commuters and the availability of CCF monies for the financing of ferries. Would you outline your thinking on this subject?

**Schubert:** Ferries are becoming increasingly important as a means for commuter transportation. Selected urban locations like New York and Boston have seen new ferry services introduced after a 30 or more

Maritime Reporter & Engineering News

year hiatus. In New York City prior to the events of September 11th non-subsidized ferry operators were providing 30,000 passenger trips per day between multiple locations in northern New Jersey and Manhattan. Today, these passenger figures have more than doubled. The City has announced its intention to lead in the development of a regional passenger ferry transportation plan with the construction of what The New York Times has described as a "flotilla" of new ferry terminals.

In San Francisco commuter ferry services were never entirely discontinued in the Post World War II period. We are seeing the expanding re-institution of various cross Bay services to provide commuting alternatives to the bridges and the Bay Area Rapid Transit (BART) system. A Blue Ribbon Committee of business and political leaders has developed a plan for "the world's best" high speed Bay Area water transit system with a fleet of 70 boats. In late August, the state chartered Water Transit Authority announced a scaled back 44 boat version of that Blue Ribbon plan calling for the expansion of capacity by existing ferry services, and the addition of seven new routes.

The reasons for these developments are the same as those, which we have already discussed, crowded highways and gridlock in tunnel and bridge crossings. We are unlikely to see a newly constructed Lincoln Tunnel or Golden Gate Bridge during our lifetimes.

MarAd's Title XI Program has had a significant impact in New York. There, through the use of Title XI, the principal operator has been able to reduce its annual debt service payments by roughly one half. And, they have been able to maintain a competitive rate structure in a service that is privately owned and operated without any operating subsidy from New York City or New York State. MarAd is proud of this. We are currently working on new ferry projects with several other groups.

We believe that changes in the CCF regime of the sort that I presented in my March authorization testimony would probably be beneficial here. The extension of

CCF along those lines could provide money for immediate ferry construction from existing CCF deposits. It would also enable ferry operators to accumulate the money needed for fleet expansion on a more rapid, before tax, basis. We are looking at this and other options, and also working with FHWA to identify alternative means to access the capital that will be needed for ferry construction.

**Cook:** I understand that MarAd is a participant in an Administration initiative called the Marine Transportation System. Would you tell us about that?

**Schubert:** The Marine Transportation System (MTS) is a U.S. Department of Transportation effort to identify and study our waterways as an integrated national system. The objective is to develop a national plan for waterborne transportation to meet 21st century needs. The MTS project was initiated in 1998. MarAd and the U.S. Coast Guard have played leading roles in the MTS Task Force work to improve coordination of waterborne transportation efforts at the national, regional and local levels. There are now public and private sector committees, and an MTS National Advisory Council, a chartered non-federal body, whose purpose is to advise the Secretary of Transportation on MTS issues.

MarAd continues as an active participant and chairs the public sector subcommittee on ferries. We are working to bring together at MarAd the expertise of the 6 or 7 federal agencies that have an impact on ferry operations. In this way the private sector parties interested in a project will be able to come to MarAd and obtain all the information necessary for ferry project development.

MarAd is also working with FHWA, the U.S. Coast Guard, the Passenger Vessel Association (PVA), the San Francisco Bay Area Water Transit Authority and several metropolitan planning authorities, to develop the agenda for a ferry conference to be held in conjunction with the PVA annual meeting in San Diego in

early 2003. Representatives from all of our existing ferry vessel operators, and from most projects that are in progress, will be in attendance. It should provide a useful venue for a MarAd report of its MTS and other ferry related action to the private sector.

**Schubert:** I'm afraid our time is up. I appreciate your coming in. I've enjoyed our two meetings and the opportunity that they will provide to make contact with *Maritime Reporter* readers.

**Cook:** Before I leave, I see that you have a picture on your desk of what look like two Labrador retrievers. Could you tell our readers a little bit about them?

**Schubert:** They are Labrador retrievers. One is a Golden and the other a Chocolate. Their names are Cody and Samson. Now that Gail and I are settled in a house in Annapolis we are able to have them with us.

**About the Author**

**H. Clayton Cook, Jr.,** B.S. Princeton University, LLB The University of Virginia. Mr. Cook served as General Counsel of the U. S. Maritime Administration from 1970 to 1973, where he was responsible for the implementation of the Merchant Marine Act of 1970, and the drafting of the Federal Ship Financing Act of 1972. Upon completing his government service, Mr. Cook joined Cadwalader, Wickersham & Taft as the partner responsible for the development of that firm's Washington Maritime practice. Mr. Cook continues his law practice today as Counsel to Bastianelli, Brown & Kelley, Chartered, in that firm's Washington, D.C. offices. He is also a partner in Management & Transportation Associates, Inc., a management consulting firm based in Essex, Conn. Mr. Cook's email address is PlimsollDC@aol.com.

**Marine A/C by Flagship Marine**

**Chosen over all others by the US & Canadian Coast Guard since 1996**

**1-20 Tons Water, Air & Keel cooled**

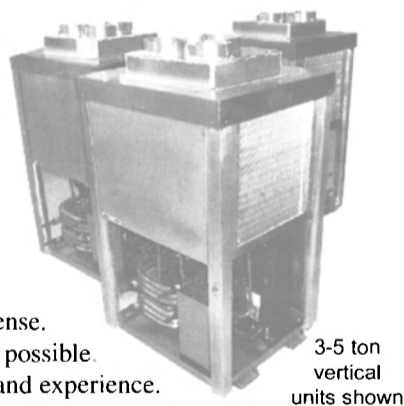

Lowest long-term maintenance expense.  
The most durable and simple design possible.  
Evolved over many years of testing and experience.

Rooftop air cooled **Marine** a/c by the legendary RVP - Coleman® Mach®



**Ideal for; Cranes, Pilothouse, Flybridge, Workboats, Containers, Liveboards: 13,500 BTUs with heat & Install kit Only \$899.95!**

[www.flagshipmarine.com](http://www.flagshipmarine.com) [sales@flagshipmarine.com](mailto:sales@flagshipmarine.com)



Phone: 772-283-1609 Fax: 772-283-4611  
Watts: 800-316-6426 Stuart, FL USA

Manufactured with pride in the USA

Circle 231 on Reader Service Card or visit [www.maritimereporterinfo.com](http://www.maritimereporterinfo.com)

**ISLAND BOATS, INC.**

**ALUMINUM CATAMARANS & UTILITY CRAFT**

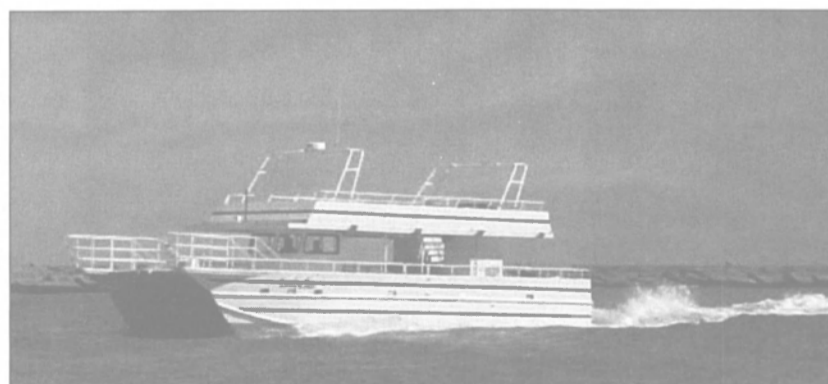

VESSEL SHOWN IS A 60' x 20' USCG CERTIFIED 100 PAX EXCURSION/FERRY CATAMARAN. DESIGN BY MORRELLI & MELVIN

**FEATURES**

- \*USCG/ABS CERTIFICATION \*HULLS TO 100'
- \*RUGGED ALUMINUM HULLS \*CAD/CAM METHODS \*NC PLASMA CUTTING
- \*SEVERAL STOCK HULLS \*PLANING & DISPLACEMENT HULL
- ◆ COMPETITIVE PRICING TO EAST/WEST COAST BUILDERS
- ◆ BOATS UNDER CONSTRUCTION (2) 65' UTILITY LANDING CRAFT
- PASSENGER FERRIES • SHIP TENDERS •**
- EXCURSION VESSEL • PILOT BOATS • CREW BOATS**

**ISLAND BOATS, INC.**

6806 HWY 90 EAST NEW IBERIA, LA 70560 PH: 337-560-4483 FAX: 337-560-4473  
EMAIL: [islandboats@eatel.net](mailto:islandboats@eatel.net)

Circle 244 on Reader Service Card or visit [www.maritimereporterinfo.com](http://www.maritimereporterinfo.com)

## People

### Pacific Fisherman Shipyard Elects Myrseth President

The board of directors of Pacific Fishermen, Inc. has elected new officers, including:

**Robert Myrseth** as president; **Warren Aakervik, Jr.** as vice president; **Ann Salvesen** as secretary/treasurer; and **Doug Dixon** as general manager.

The election of officers followed the election at the Annual Shareholders Meeting of the following three new members of the board of directors for three-year terms: **Gunnar Ildhuso, Sr.**, Crab and trawl fishing pioneer and owner of the F/V Margun and F/V Gunmar; **Jack Knutsen**, longline fisherman and owner of the halibut and blackcod schooner F/V Grant; and **Jerry Horn**, past board member and office manager of Pacific Fishermen, Inc.

### Richardson Joins Waller Marine

Waller Marine has appointed **Wayne Richardson** as Sales and Marketing manager, bringing to the organization, more than 25 years of experience in the offshore and marine industry.

He will oversee all marketing and sales communication for Waller Marine, Inc., one of the leaders in the design technology of barge-mounted power plants, GTL Plantships and offshore marine vessels.

*In the August 2002 edition of Maritime Reporter & Engineering News, the article, "Get Ready for the New OPA 90," the e-mail address for contact person Rick Fernandes was listed incorrectly. The correct address is rick@jmsnet.com.*

## Correction

The information published in the July 2002 edition "Marine Diesel Directory" for Caterpillar Motoren GmbH & Co. KG was incorrect. The correct details are as follows.

### Caterpillar Motoren GmbH & Co. KG

Falckensteiner Str. 2, 24159 Kiel/Germany; P. O. Box, 24157 Kiel/Germany,  
Tel. +49 (0) 431 3995-01, Fax +49 (0) 431 3995-2193  
E-mail: ju\_marketing@CAT.com; Internet: http://www.mak-global.com

Model	Cycle	Cylinders	Bore (mm)	Stroke (mm)	Mean Piston (m/s)	Speed (rev/min)	Output (kW/cyl)	Output range (kW)	Bmep (bar)	Sfac (g/kWh)
MaK M 20	4	6,8,9 L	200	300	9.0/10.0	900/1000	170/190	1020 - 1710	24.1/24.2	186 - 190
MaK M 25	4	6,8,9 L	255	400	9.6/10.0	720/750	290 - 308	1800 - 2700	24.5 - 23.5	182 - 183
MaK M 32 C	4	6,8,9 L	320	480	9.6	600	480	2880 - 4320	24.9	178
	4	12,16 V	320	420	10.1 - 10.5	720 - 750	480/500	5760 - 8000	23.7	180
MaK M 43	4	6,7,8,9 L	430	610	10.2/10.5	500/514	900	5400 - 8100	24.4/23.7	176
	4	12,16,18 V	430	610	10.2/10.5	500/514	900	10800 - 16200	24.4/23.7	176



## G.R. BOWLER, INC.

### Precision Measurement & Specialty Sensor Technology



XTC 330G Gauge Pressure Transmitter

G.R. Bowler, Inc. and MycroSENSOR™ Technologies announce the XTC™ 330 transmitter family with the American Bureau of Shipping (ABS Type approved). The transmitter is available in absolute, gauge and differential pressure models.

A measurement is only as good as the sensor used to make it. The MycroSENSOR Dual Capacitor design is the best sensor available on the market! This design provides:

- Outstanding Stability: ±0.030% of URL for 36 months
- Excellent Reference Accuracy: ±0.075% of calibrated range
- Proven Reliability and Robustness

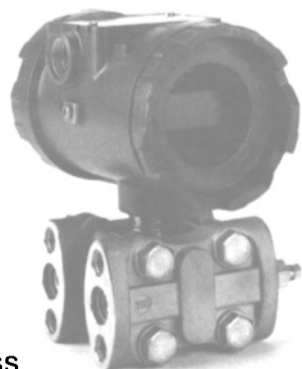

XTC 330D Differential Pressure Transmitter

**G.R. Bowler Inc., a leader in marine control systems for 30 years.**

G. R. Bowler, Inc.  
2261 Lake Rd.  
Ontario, NY 14519-9719  
www.grbowler.com

800-524-9570  
Fax 315-524-8753  
sales@grbowler.com

Circle 340 on Reader Service Card  
or visit [www.maritimereporterinfo.com](http://www.maritimereporterinfo.com)



## Omnithruster™

Marine Maneuvering and Propulsion Systems

## TECHNICAL READOUT

### PATENTED SYSTEM

- Kinetic Converter takes input shaft energy and produces usable hydraulic energy by the use of a mixed flow impeller.
- Steering Vanes continuously meter or proportion a percentage of the fluid flow to one or both sides of the vessel.
- Nozzles accelerate the mass of water creating a thrust force at the hull interface.
- Thrust Directors (optional) deflect the water flow forward or aft producing slow speed auxiliary propulsion.
- Electronic Control System controls the 360° thrust vector resultant from a fixed or variable speed prime mover rotating continuously in one direction.
- There are no rotating parts that have to be stopped or started as thrust direction and/or magnitude changes.

### Mixed-Flow Impeller

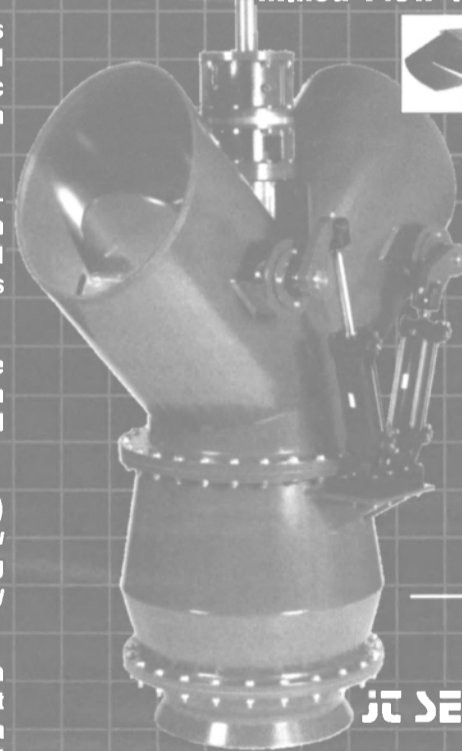

HC SERIES

HC SERIES

38555 Solon Industrial Parkway • Cleveland, OH 44138  
448 542 8288  
[www.omnithruster.com](http://www.omnithruster.com)

Circle 274 on Reader Service Card  
or visit [www.maritimereporterinfo.com](http://www.maritimereporterinfo.com)



### Bender Shipbuilding & Repair Promotes Pinkham

Bender Shipbuilding & Repair Co. Inc. and Tampa Bay Shipbuilding & Repair Company have promoted **Michael Pinkham** to Ship Repair Sales Manager for both the Mobile and Tampa yards.

The Sales and Marketing Departments of both companies have been combined to more efficiently and economically service customer accounts. Pinkham brings his many years of ship repair sales, production and estimating experience to this position. He will be responsible for coordinating the efforts of Sales currently working for both yards in the domestic market, as well as coordinating opportunities from the international markets.

### Port Authority Receives Approval

The Port Authority has received approval from the Army Corps of Engineers to deepen a section of the Kill van Kull to 50 ft., launching the agency's ambitious \$1.8 billion project to dredge the region's harbor channels to 50 feet and maintain its ranking as the leading East Coast destination for shippers from around the world.

Under eight separate dredging contracts, the Corps and the Port Authority are working together to deepen the Kill Van Kull from 40 to 45 ft. In the near term, the Corps' new action will allow the Port Authority to augment one of those contracts to deepen a section of the Kill van Kull around Bergen Point to 50 ft.

The work, being done between Bayonne and Staten Island, will save time and money by allowing the deepening work to be completed during the scope of a single project, rather than in two separate projects.

In the long-term, the decision by the Corps makes similar project consolidations possible to achieve 50-ft. depths faster throughout the Port.

The 45-ft. Kill Van Kull deepening project is scheduled to be completed by the end of 2004. The Port Authority is working with the Army Corps and other federal and state regulatory agencies toward the goal of completing the 50-foot project by 2009.

### MOL Promotes Two

MOL (America) Inc. has promoted **Diana Jackson** and **JoAnn Yourcheck** to Director level positions.

Jackson, who was promoted to the position of Director, Equipment Control for North America, Caribbean, and Central America is currently based in Seattle, Wash., and will soon relocate to the company's office located in the Chicago suburb of Elmhurst, Ill.

Yourcheck has been promoted to a newly created position, Director of

Business Processes for North America, Caribbean, Central and South America.

### New York Firm Building in Louisiana

September 11 set things back all over the world and especially in New York. But now a maritime firm in that city has a new tug building at Thoma-Sea Boat

Builders in Houma Louisiana. The model bow tug, essentially a sister ship to one delivered last January, is a 3,400-hp ocean-going tug, 100 x 32 ft. (30.4 x 9.7 m) with a molded depth of 14 ft. (4.2 m). Delivery is scheduled for approximately January 2003.

Designed by Frank Basil's Entech and Associates of Houma La. the boat will

be powered by a pair of 16-cylinder Cummins KTA50 main engines rated for 1700 HP at 1,800 rpm.

The engines will turn into Rentjes WAF-772 gears with ratios of 7.087:1 and turning 87-in. Sound propellers in 88-inch Rice nozzles.

The boat is designed for a bollard pull of 60 tons.

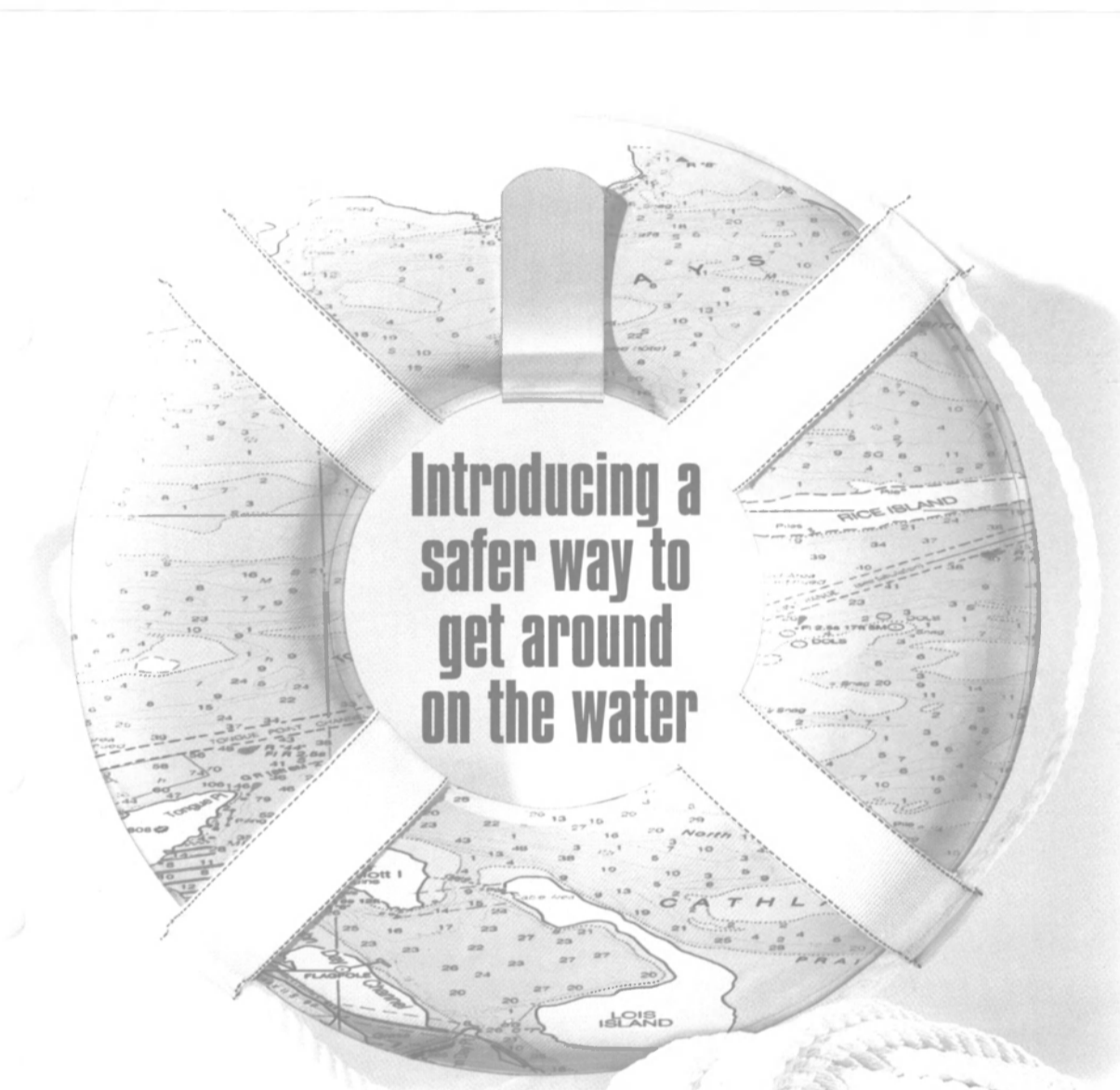

### Announcing a stunning advance in navigation safety — the New Nautical Chart.

Using cutting edge technology, NOAA now updates charts daily and they're printed only when your chart agent places an order. All Notices to Mariners and other critical changes are fully applied just before yours are printed. The new charts show you the latest discoveries like channel changes and other hazards, so you sail safer.

There are other improvements too. These rugged charts are water-resistant and have a tough coating that's easy to write on. Brighter colors are easy to read. And there are two versions with boatloads of useful information in the margins — tide tables, emergency numbers, frequencies, rules of the road — one version for recreational boaters and one for professionals.

Waterways change like the tides. So the next time you're ready to cast off, carry the latest life-saver on board. Put safety first. Get the new, up-to-date nautical charts from your marine supplier or contact NOAA at 1-800-584-4683 or [www.NauticalCharts.gov](http://www.NauticalCharts.gov).



**National Oceanic and Atmospheric Administration**  
National Ocean Service  
Office of Coast Survey

Circle 269 on Reader Service Card or visit [www.maritimereporterinfo.com](http://www.maritimereporterinfo.com)

## People

### Palmer Johnson Mourns Loss

The people of Palmer Johnson Yachts, as well as the international maritime community are mourning the loss of Chairman Emeritus **Mike Kelsey, Sr.**, who passed away on July 21, 2002.

Kelsey was largely responsible for building the company into one of the world's leading custom yacht brands, as

a yacht builder and also a provider of yacht refit/repair services, brokerage, chandlery and related support services.

Kelsey moved to Sturgeon Bay, Wis., from Texas in 1962, when he became vice president of service and repair for Palmer Johnson. He quickly rose to president and then chairman of the company.

### Ryan Assumes SUNY Maritime Presidency

Vice Admiral **John R. Ryan** assumed the presidency of the State University of New York Maritime College during a ceremony held aboard Empire State VI while it was docked in Dublin, Ireland. Formerly the Superintendent of the U.S. Naval Academy, Vice Admiral Ryan is



the College's 32nd president since its founding in 1874. Prior to serving as the 56th Superintendent of the United States Naval Academy, Vice Admiral Ryan was the Commander of the Maritime Surveillance and Reconnaissance Force, U.S. Sixth Fleet/Commander, Fleet Air Mediterranean/Commander, Maritime Air Forces located in Naples, Italy.

### KMSS Appoints New President

Subsequent to the completion of Per Branstad's two-year assignment to organize and integrate the three companies, which together now comprise an important part of Kongsberg's Marine and Offshore Operations, Branstad will now return to his specialist field within Kongsberg in the development of the Maritime Training Business.



**Lars Gørvell-Dahll** has assumed the role as president of KMSS, setting his sights firmly on developing the company worldwide and especially within the Asian market, which is already the center of the world ship building industry. Gørvell-Dahll is highly experienced in international shipbuilding having worked for many years based in Indonesia, Singapore and Hong Kong. After graduating from the Royal Norwegian Naval Academy he spent five years in the Navy reaching Lt. Commander and Chief Engineer.

### Celebrity Names Hancock As Marketing Head

Celebrity Cruises appointed senior marketer **Steven Hancock** to lead intensified marketing efforts for the premium brand. In his new role, Hancock will assume broad-reaching responsibilities for consolidating Celebrity's brand messaging and widening its customer base.

Hancock has a unique background and specialty qualifying him for his new job. He has spent the last two decades at financial services leader Citigroup, where he rotated among fast-moving, start-up business groups, with the sole focus of accelerating growth.

**Maritime Reporter & Engineering News**

Lloyd's List events

Presents

# ShipRepair & Conversion

The Ship Maintenance Exhibition and Conference

27th & 28th November 2002  
Grand Hall Olympia, London

[www.shiprepair.com](http://www.shiprepair.com)

informa  
maritime  
& transport

Please complete and return to the ShipRepair & Conversion Secretariat, Lloyd's List events, 69-77 Paul Street, London EC2A 4LQ, UK. Tel: +44 (0)20 7553 1439 Fax: +44 (0)20 7553 1820 Email: [michelle.fisk@informa.com](mailto:michelle.fisk@informa.com)

Please send me more details on ShipRepair & Conversion 2002  
Exhibiting  Visiting  Attending the Conference

Name	Position
Company	Business Type
Address	
Postcode	Telephone
Fax	E-mail

"Lloyd's" is the trademark of the society incorporated by the Lloyd's Act 1871 in the name of "Lloyd's"

DATA PROTECTION  
The personal information shown on this brochure, or provided by you, will be held on a database and may be shared with companies in the Informa Group in the UK and internationally. Sometimes your details may be obtained from, or made available to, external companies for marketing purposes. If you do not wish your details to be used for this purpose, please write to the Database Manager, Informa Group PLC, Enterprise House, 45 Station Approach, West Byfleet, Surrey KT14 8NN. Telephone: +44 (0)1932 893600. Fax: (0)1932 893612. e-mail: [database@informa.com](mailto:database@informa.com)

Circle 334 on Reader Service Card or visit [www.maritimereporterinfo.com](http://www.maritimereporterinfo.com)

**SENESCO Expands Management Team**

Southeastern New England Shipbuilding Corporation (SENESCO) has appointed four new executives in a move prompted by the company's rapid growth over the past six



**Gordon W. Fletcher**

months.

The new executives include the company's first CFO and other senior level financial and operations staff.

New members of the executive team include **Gordon W. Fletcher**,



**Edward S. Kracunas**

who was appointed as SENESCO's first CFO.

SENESCO also elected **Edward S. Kracunas** as vice president of Operations. Kracunas will work directly with company president and CEO **Robert Jarvis** in over-



**Christine Mouris**

seeing day-to-day operations at the shipyard.

**Christine Mouris** was appointed as accounting manager directly reporting to the new CFO, and **Jonathan S. Cutone** will serve as SENESCO's senior project manager.



**Jonathan S. Cutone**

**TT Club Appoints Lewin COO**

TT Club, has appointed **Colin Lewin** as COO, effective October 1, 2002. Lewin, currently Asia Pacific regional manager for TT Club, will take over the operational management of underwriting and claims in order to leave



**Colin Lewin**

CEO **Paul Neagle** free to manage the strategic development of the business following its planning initiative last year with Ernst & Young.

**SOCP to Meet in Castine**

The Ship Operations Cooperative Program (SOCP) is scheduled to hold a meeting on October 16-17, 2002, in Castine, Maine.

Agenda highlights include a U.S. Coast Guard Advisory Workshop on the Reengineering of the Marine Licensing and Documentation Program and an SOCP Mariner Administrative Smart Card Project Demonstration.

**Metro Stevedore Appoints Two**

Metropolitan Stevedore Co., a West Coast general and bulk cargo contract stevedore and terminal operating company, has elected **John R. Hampton** as vice president and CFO; and **Philip Poggi** as controller.



**John Hampton**

Hampton, who holds an M.B.A. from Pepperdine University, began his career with Metropolitan in 1993 as its maintenance manager. In 1997, he was promoted to marketing representative

and relocated to the corporate office in Wilmington, Calif.



**Philip Poggi**

Poggi joined Metropolitan Stevedore Co. in July 1994 as its senior accountant, supervising the general accounting department. When the cost accounting and general accounting departments were consolidated in 1999, he was promoted to financial reporting manager. Prior to joining with Metro, Poggi handled various accounting and finance functions at First Interstate Bank.

***You Handle Production...  
... Let Us Supply the People***

At Ameri-Force, Inc. we have been supplying top notch craftspeople to major U.S Shipyards since 1991. What do we have to offer?

***Quality Craftspeople:***

- Welders
- Shipfitters
- Pipefitters
- Pipewelders
- Sheet metal mechanics
- Machinists
- Electricians
- Riggers
- Painter/Blasters

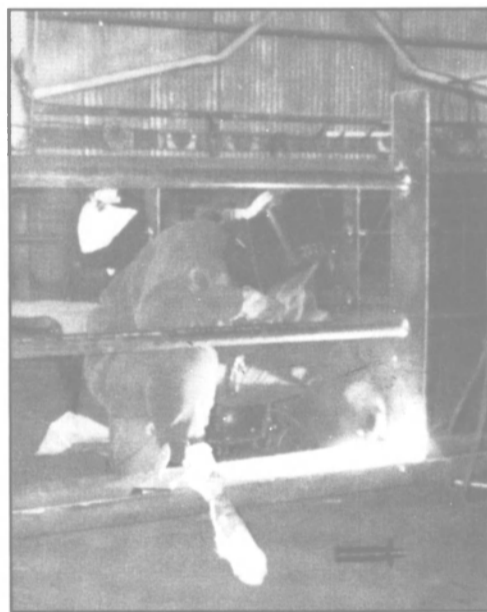

Jacksonville, FL  
Charleston, SC  
Norfolk, VA  
Mobile, AL  
Hampton, VA  
New Orleans, LA

- Quality Personnel
- Insurance to meet your needs
- Quick Response Time
- Professional coordination
- Safety Trained Workforce
- Extensive Marine Experience

**AMERI-FORCE, INC.**

**1 800 633-4096**

[www.ameriforce.com](http://www.ameriforce.com)

SEE US AT INT'L WORKBOAT SHOW BOOTH #2030

**The Work Force Specialists**



Circle 329 on Reader Service Card or visit [www.maritimereporterinfo.com](http://www.maritimereporterinfo.com)

# INFORMATION

S H O W C A S E

GET FREE INFORMATION ONLINE at: [www.maritimereporterinfo.com](http://www.maritimereporterinfo.com)

## Get Free Information Fast

Circle the appropriate Reader Service Number  
on the opposite page or visit  
[www.maritimereporterinfo.com](http://www.maritimereporterinfo.com)



Page	Advertiser	Product	R/S#	Page	Advertiser	Product	R/S#
63	2002 Global Marine Directory	CD-Rom	353	52G	MAN B&W Diesel AG	turbochargers	258
6	ABB Turbosystems AG	turbochargers	200	44	Mapeco	couplings	259
37	Air Products AS	gas generation systems	201	77	Marine Exhaust Systems of Alabama	water cooled manifolds	260
29	Airvac	vacuum systems	202	20	Mariso USA	spare parts	261
8	Albacore Research Ltd.	CAD/CAM	203	77	Maritime Associates	marine and offshore signage	262
53	Alstom Power & Conversion	electric propulsion pod	204	8	Martek Marine Blinds Ltd.	bridge sunscreens	331
25	American Vulkan	couplings	205	84	Mascoat Products	coatings/marine insulation	263
89	Ameri-Force	skilled laborers	329	44	MetalCraft Marine Inc.	aluminum boat builders	346
70	Anchor Lamina	portable hydraulic drilling equipment	206	74	Mi-Jack Products	container handling	345
4	Anchor Marine	marine equipment	207	55	MITAGS	training and education	264
84	Arion International Inc.	marine thermal imaging	208	58	MMC Int'l	tank gauging tapes	265
52D	Auramarine Ltd.	power plant systems	209	52	Motor-Service AB	diesel engine parts	266
29	BAE Systems	windows & wipers	210	14	Motor-Services Hugo Stamp	diesel engine repairs	267
23	Ballast Technologies	ballast	211	64	Napier Turbochargers	turbochargers	352
51	Benjamin R. Vickers & Son Ltd.	lubricants	212	77	Nautican	nozzles	343
38	Boll Filter Corp.	filters	213	47	NautiCast AG	AIS transponder	337
52D	Brunvoll A/S	thruster systems	214	50	NLB Corp.	surface prep equipment	349
36	C.M. Hammar AB	life saving equipment	215	87	NOAA Office of Coast Survey	navigation charts	269
39	Cadmatic	CAD/CAM	216	52A	North American Marine Jet	jet products	270
76	Calhoun MEBA Engineering School	engineering school	347	52E	Nya Berg Propulsion AB	propulsion	271
76	Capt. R.J. Underhill & Assocs.	consultants	217	38	O.W.Bunker & Trading	bunkering company	272
68	Cashman Equipment	barge rentals	218	18	Oceangrafix	charts	326
25	Chartco	navigational chart updates	319	19	Offshore Communications 2002	exhibition	273
42	C-Map Commercial	electronic charts	336	56	Oilfield Electric Marine	water cooled AC drives	318
72	Companion Products	oil safe professional lubrication systems	350	86	Omnithruster Inc.	thrusters	274
C3	Cooper Bearing	bearings	219	68	Orkot	bearings	275
64	Cospolich Refrigeration	refrigeration	351	4	Panduit Corp.	electrical products	276
C2	Craft Bearings	bearings	220	76	Philadelphia Resins	coating systems	277
8	Creative Systems	software	221	80	Pipe Painter	products & services	278
44	CSD North America	sealing systems	339	79	Plastic Piling	navigational marker	279
45	Curacao Drydock Co.	ship repair yard	222	80	Redland Genstar	ballast crete	280
33	Dayton T. Brown	shipboard testing	223	35	Restech Norway A/S	pneumatic line throwers	281
31	The Delamar Company	slade fluid sealing	303	23	Resurgence Software Inc.	software systems	342
3	Detroit Diesel	diesel engines	224	32	Ritchie Bros. Auctioneers	auction	316
26	Duramax	heat exchangers	317	16	RTM Star Center	training	268
31	Electronic Marine Systems	tank level indicators	225	13	Rutter Technologies	voyage data recorders	330
33	Electronic Marine Systems	tank level indicators	226	51	RWO GMBH	water technology	282
35	Electronic Marine Systems	tank level indicators	227	7	Rydex:An Immarsat Venture	marine data solutions	283
37	Electronic Marine Systems	tank level indicators	228	42	Saab Marine Electronics	marine electronics	284
81	ElectroWave USA	electronic monitoring/control systems	328	19	Sasakura Engineering	fresh water generator	285
2	Envirovac	sanitation systems	229	54	Schottel Inc.	propulsion	286
85	Flagship Marine	marine air conditioners	231	80	Schuyler Rubber Co.	fenders	287
52	Flow International	water jet cleaning	335	76	Sea Ark Marine	boatbuilders	327
77	G.J. Wortelboer	chains	232	5	Sea Tel Inc.	communications	288
86	G.R. Bowler	control/monitoring systems	340	90	Seatrade Cruise Shipping CMP	convention	315
41	GE Marine	engines	338	59	Seaward Intl.	fenders	289
52C	Geislinger	couplings	233	67	SENECO	shipbuilding & repair	356
36	Georgia Pacific	Dens-Marine bulkhead panel	322	37	Serck Como GMBH	fresh water generators	290
28	GMT Electronics	marine electronics	341	88	Ship Repair & Conversion Informa	exhibition	334
12	Goltens Marine Co.	diesel engine repair	234	35	ShipTech A/S	marine consultant	291
52H	Haaglunds Drives AB	drive systems	235	10	Skookum	rigging products	292
20	Harbormaster Marine	propulsion systems	236	75	Sohre Turbomachinery	grounding brushes	293
76	Harrington Marine	kort nozzles	237	56	Spurs Marine	line and net cutters	294
24	Hatteland Display	maritime multi display	238	54	Stork Bronswerk	air conditioning/refrigeration	295
25	Headhunter Inc.	toilets	325	30	Stork-Kwant	electric shaft systems	296
4	Hellan Strainer	filtration equipment	239	65	Standard Horizon	marine electronics	355
75	Hepworth Marine	windscreen/window wipers	240	82	Stratos	satellite communications	297
67	Hernis Scan Systems A/S	closed circuit television	354	52	Superbolt	bolts	298
12	IFTSA/Fire Service Programs	fire fighting manuals	241	31	Superior Energies	insulation	299
27	Incat Australia Pty. Ltd.	fast vessels	242	21	Superior Lidgerwood Mundy	deck mahinery	300
23	In-Place Machining	crankshaft repair	243	52F	Tano Corp	propulsion control systems	333
81	Inventory Locator Service	parts & locator service	348	24	Taylormade Environmental	air conditioning	301
85	Island Boats	boat builders	244	80	Technofibre Pte. Ltd.	lifeboat and davit maintenance	320
15	IZAR	shipbuilders	245	49	Telenor Broadband	satellite communications	302
17	Japan Radio	communications	257	16	Thermax	bulkhead panels	304
75	Jastram Engineering	steering systems	246	69	Thordon Bearings Inc.	bearings	305
30	Jeamar Winches	winches	247	47	Thrane & Thrane A/S	communications	306
25	Jesse Engineering	flanges	321	11	Urethane Products	foam filled fenders	307
28	John J. McMullen	naval architects	248	1	USMMA	training	308
49	Jotron Electronics	marine electronics	249	43	Voith Schiffstechnik GMBH & Co.KG	drive systems	309
80	Kaplan & Assocs.	propulsion parts & products	250	57	Wartsila Corporation	propulsion	310
C4	Karl Senner	marine propulsion equipment	251	52F	Wartsila Lips	propulsion systems	324
52B	Kawasaki Heavy Industries	marine equipment	252	10	Water Weights	load management solutions	311
70	King Engineering	tank leveling	253	75	Waterman Supply	marine equipment	312
8	LC Doane	lighting systems	254	77	Western Machine Works	deck machinery	313
61	L-3 Communications	VDR-AIS-VHF	332	73	Willard Marine	RIBS	344
21	Lantec	winches	323	10	Wolong International Pte.Ltd.	lifeboat manufacturers	230
9	Leslie Controls	valves	255	10	Wynn Marine Ltd.	windscreen/window wipers	314
71	Liebherr-Werk Nenzing GMBH	marine cranes	256				

The listings above are an editorial service provided for the convenience of our readers.



**SENESCO Expands Management Team**

Southeastern New England Shipbuilding Corporation (SENESCO) has appointed four new executives in a move prompted by the company's rapid growth over the past six



**Gordon W. Fletcher**

months.

The new executives include the company's first CFO and other senior level financial and operations staff.

New members of the executive team include **Gordon W. Fletcher**,



**Edward S. Kracunas**

who was appointed as SENESCO's first CFO.

SENESCO also elected **Edward S. Kracunas** as vice president of Operations. Kracunas will work directly with company president and CEO **Robert Jarvis** in over-



**Christine Mouris**

seeing day-to-day operations at the shipyard.

**Christine Mouris** was appointed as accounting manager directly reporting to the new CFO, and **Jonathan S. Cutone** will serve as SENESCO's senior project manager.



**Jonathan S. Cutone**

**TT Club Appoints Lewin COO**

TT Club, has appointed **Colin Lewin** as COO, effective October 1, 2002. Lewin, currently Asia Pacific regional manager for TT Club, will take over the operational management of underwriting and claims in order to leave CEO **Paul Neagle** free to manage the strategic development of the business following its planning initiative last year with Ernst & Young.



**Colin Lewin**

**SOCF to Meet in Castine**

The Ship Operations Cooperative Program (SOCF) is scheduled to hold a meeting on October 16-17, 2002, in Castine, Maine.

Agenda highlights include a U.S. Coast Guard Advisory Workshop on the Reengineering of the Marine Licensing and Documentation Program and an SOCF Mariner Administrative Smart Card Project Demonstration.

**Metro Stevedore Appoints Two**

Metropolitan Stevedore Co., a West Coast general and bulk cargo contract stevedore and terminal operating company, has elected **John R. Hampton** as vice president and CFO; and **Philip Poggi** as controller.



**John Hampton**

Hampton, who holds an M.B.A. from Pepperdine University, began his career with Metropolitan in 1993 as its maintenance manager. In 1997, he was promoted to marketing representative and relocated to the corporate office in Wilmington, Calif.



**Philip Poggi**

Poggi joined Metropolitan Stevedore Co. in July 1994 as its senior accountant, supervising the general accounting department. When the cost accounting and general accounting departments were consolidated in 1999, he was promoted to financial reporting manager. Prior to joining with Metro, Poggi handled various accounting and finance functions at First Interstate Bank.

*You Handle Production...  
... Let Us Supply the People*

At Ameri-Force, Inc. we have been supplying top notch craftspeople to major U.S Shipyards since 1991. What do we have to offer?

**Quality Craftspeople:**

- Welders
- Shipfitters
- Pipefitters
- Pipewelders
- Sheet metal mechanics
- Machinists
- Electricians
- Riggers
- Painter/Blasters



Jacksonville, FL  
Charleston, SC  
Norfolk, VA  
Mobile, AL  
Hampton, VA  
New Orleans, LA

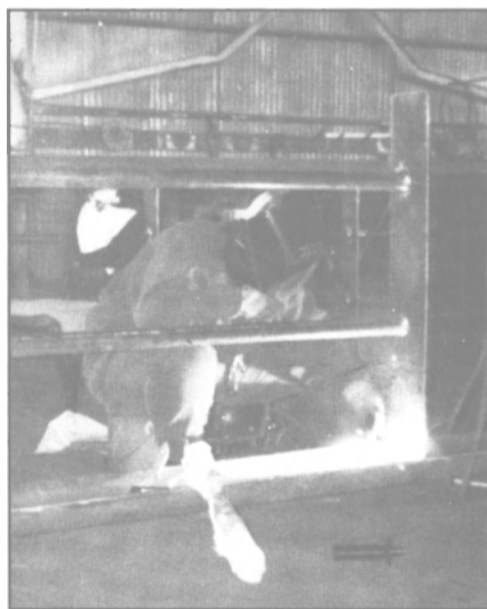

- Quality Personnel
- Insurance to meet your needs
- Quick Response Time
- Professional coordination
- Safety Trained Workforce
- Extensive Marine Experience

**AMERI-FORCE, INC.**

**1 800 633-4096**

[www.ameriforce.com](http://www.ameriforce.com)

SEE US AT INT'L WORKBOAT SHOW BOOTH #2030

**The Work Force Specialists**



**AMERI-FORCE**



**AMERI-FORCE**

Circle 329 on Reader Service Card or visit [www.maritimereporterinfo.com](http://www.maritimereporterinfo.com)

# Book NOW for 2003

**3 DAY**

Trade Show

March 4-5-6



**4 DAY**

Conference

March 3-4-5-6

The International Exhibition & Conference  
Serving the Cruise Industry

**March 3-7, 2003**

**Miami Beach, Florida, USA**

CMP Princeton Inc.

Tel: +1 609 452 2800 • Fax: +1 609 452 9374

email: [info@cruiseshipping.net](mailto:info@cruiseshipping.net)

Sponsored by:

Florida-Caribbean Cruise Association (FCCA)  
International Council of Cruise Lines (ICCL)



[www.cruiseshipping.net](http://www.cruiseshipping.net)

Circle 315 on Reader Service Card or visit [www.maritimereporterinfo.com](http://www.maritimereporterinfo.com)

**Ameri-Force**

Ameri-Force was founded in 1991 to service the need for skilled craftsmen and general labor in Jacksonville, Fla. Today, Ameri-Force, Inc. has expanded to eight branch offices located in the Mid-Atlantic, Southeastern and Gulf Coast States and provides between 1600 and 2000 supplemental workers to the marine, industrial and construction sectors each week.

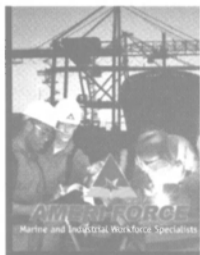

**Circle No. 101**  
[www.maritimereporterinfo.com](http://www.maritimereporterinfo.com)

**Arion International**

The Model 850 Marine Infrared Thermal Imaging Camera is designed for the patrol boat, RIB, harbor patrol, pilot boat, police boat, and commercial and work boat market. The waterproof pan/tilt Housing contains a Raytheon uncooled AS Silicon Microbolometer and a 9-degree lens to provide superior over-water performance. The Model 850 operates from 12 VDC (24 VDC available) and can be used to augment Radar navigation; provide collision avoidance imagery; and to aid in search/rescue operations.



**Circle No. 102**  
[www.maritimereporterinfo.com](http://www.maritimereporterinfo.com)

**Chartco**

The ChartCo system, which is widely fitted onboard SOLAS vessels to ensure the prompt receipt of critical navigation and weather data, can also be used to receive daily and weekly news. Using the Inmarsat Point to Multipoint Service, satellite broadcast provides an efficient method of providing ships crews with up to date news while at sea. This information service is available at competitive fixed rates and does not detract from satellite communications system availability for operational and commercial traffic.



**Circle No. 103**  
[www.maritimereporterinfo.com](http://www.maritimereporterinfo.com)

**CompAir**

Since 1898, CompAir has been designing, manufacturing and installing compressed air and gas systems for specialized markets and becoming synonymous with the high standards of quality and long term support capabilities. Their range of seawater, freshwater and air cooled high, medium and low pressure air and gas compression systems comply with all internationally recognized approval standards.



**Circle No. 104**  
[www.maritimereporterinfo.com](http://www.maritimereporterinfo.com)

**Future Pipe**

The Future Pipe Group is a globally operating group of companies specializing in high performance glass reinforced polyester (GRP), glass reinforced epoxy (GRE) systems, polyethylene and concrete pipe as well as storage tanks, floats for the dredging industry, and coring tubes for the offshore exploration and onshore markets. The Group has manufacturing facilities located in The Netherlands, Dubai, Abu Dhabi, Lebanon, Egypt and Qatar — a production and delivery capability serving any location.



**Circle No. 105**  
[www.maritimereporterinfo.com](http://www.maritimereporterinfo.com)

**Holly Hoist**

The Single-Boom Davit was developed with the experience gathered in nearly 50 years of designing and manufacturing boat hoists for private and government users. It rotates on precision machined bushings. Baseplates are designed with a minimal flare to increase deck space. The davit swings 360 degrees and is designed for general cargo lifting. All electronics and coating are designed to height and reach requirements provided by the user and in capacities ranging from 500 lbs. to 7,000 lbs.



**Circle No. 106**  
[www.maritimereporterinfo.com](http://www.maritimereporterinfo.com)

**Integro**

Integro manufactures a rugged line of Stick Welding Extensions, Whips and Ground Clamp Assemblies, and a complete Welding Pre-Heat System for preheating structural steel. Integro also manufactures Temporary Power Cords, Hand Lights and Lighting Streamers that are used to build and overhaul ships. All of Integro's products are rubber molded and designed for tough marine conditions. Integro's products are used at most major Shipyards and are known for safety and reliability.



**Circle No. 107**  
[www.maritimereporterinfo.com](http://www.maritimereporterinfo.com)

**Jotron**

Jotron Electronics has introduced a new multi-purpose strobe light to be used as a personal safety equipment. The new handy pocket-sized rugged strobe light incorporates the very latest technology. and AQ-5 has two light sources: a high intensity xenon strobe light plus a low power torch. It has 36,000 Pk lumen with a range of up to 6nm and still an endurance of 12 hours of continuous strobe operation. It runs on twin standard AA batteries for easy replacement.



**Circle No. 108**  
[www.maritimereporterinfo.com](http://www.maritimereporterinfo.com)

**King Engineering**

KING-GAGE LiquiSeal transmitters monitor ballast, fuel and service tanks. Mounts external to tank or compartment with a simple air purge connection to measure hydrostatic pressure created by liquid depth. Compatible with integrated monitoring and control systems, the 4-20 mA output signal can be transmitted several thousand feet using twisted pair cabling.



**Circle No. 109**  
[www.maritimereporterinfo.com](http://www.maritimereporterinfo.com)

**Lalizas**

For the past 20 years Lalizas has been manufacturing and providing high quality marine accessories and safety equipment to commercial and recreational vessels around the world. Through a well-established distribution network Lalizas is ready to equip your vessel with the necessary safety equipment as required by the latest regulations.



**Circle No. 110**  
[www.maritimereporterinfo.com](http://www.maritimereporterinfo.com)

**Leslie Controls**

Leslie Controls' Class DOT three-way control valve is now available. It is suitable for both converging and diverging liquid flow service. The one-piece body eliminates the tailpiece and extra gasket joint associated with conventional 3-way control valves. Spring-loaded Teflon chevron stem packing eliminates the need for periodic adjustment. Cage-guided trim reduces stem load, increases valve stability and is easily removed from the top of the valve. Since there is no need to remove the DOT from the line to replace the trim, lower maintenance cost and less down time is achieved.



**Circle No. 111**  
[www.maritimereporterinfo.com](http://www.maritimereporterinfo.com)

**MAN B&W**

The MAN B&W Diesel Group presents two new engine developments as well as the next turbocharger generation at SMM trade fair (Vessel Marine Ocean Engineering) held in Hamburg, Hall 6, Stand 6001. The international business group proves its right to technology leadership with the title "Prime Movers." The central exhibits at the stand are a huge piston of the K98MC two-stroke engine — the largest engine worldwide, and a product of the completely new developed TCA exhaust gas turbocharger series.

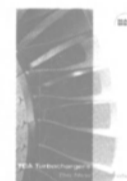

**Circle No. 112**  
[www.maritimereporterinfo.com](http://www.maritimereporterinfo.com)

**Brooke Ocean Technology**

The Moving Vessel Profiler (MVP) is a system designed by Brooke Ocean Technology and Bedford Institute of Oceanography to collect water column data while a vessel is underway. The system is now being used around the world to calibrate multibeam mapping systems and for scientific applications. Brooke Ocean Technology Limited is an internationally recognized leader in the field of Ocean profiling, Launch and Recovery Systems and seafloor Data Collection Systems.



**Circle No. 113**  
[www.maritimereporterinfo.com](http://www.maritimereporterinfo.com)

**Nauticast**

NautiCast AG is an AIS-Systems specialist, catering for the maritime and inland waterway industries. NautiCast is globally launching its AIS-Transponder, the X-Pack DS, and will enhance its AIS offering with base, and repeater stations by spring 2003. NautiCast production is ISO 9001 certified and outsourced to Siemens AG Austria. The X-Pack DS fully complies with all IMO and SOLAS regulations.



**Circle No. 114**  
[www.maritimereporterinfo.com](http://www.maritimereporterinfo.com)

**Anchor Lamina**

Powerful hydraulic drilling equipment makes a 2-in. hole in seconds, yet is compact and portable. It is heavy-duty, easy to operate and needs less maintenance than electric equipment. Drill and tap vertically or horizontally. Five heads are available, with a variety of quick-change tools.



**Circle No. 115**  
[www.maritimereporterinfo.com](http://www.maritimereporterinfo.com)

**Reiss**

Reiss Manufacturing manufactures silicone rubber seals, gaskets, tubing, grommets, shielding, sound insulation and bellows for the Marine industry. Ronsil silicone rubber can be formulated to withstand temperatures from 178 to 600 degrees. Silicone rubber is not affected by UV, ozone, minerals, many chemicals and oils, and it does not take a compression set as many organic rubber seals because of the fluctuations of outside ambient temperatures.



**Circle No. 116**  
[www.maritimereporterinfo.com](http://www.maritimereporterinfo.com)

## Products

### Severn Trent de Nora

Severn Trent De Nora offers Electrochlorination systems for water and wastewater disinfection. Our OMNIPURE systems are the only marine sewage systems that oxidize sewage in the electrochemical cell while producing NaOCL. The United States Coast Guard (USCG) and the International Maritime Organization (IMO) certify each unit in the product line.



**Circle No. 117**  
[www.maritimereporterinfo.com](http://www.maritimereporterinfo.com)

### ShipTech

With the objective to profile its services and competences, ShipTech Marine Consultants (Naval Architects & Marine Engineers) issued their new company brochure. Consultants looks forward to servicing existing and new customers.



**Circle No. 118**  
[www.maritimereporterinfo.com](http://www.maritimereporterinfo.com)

### Shoes for Crews

This past January, Shoes For Crews increased its exclusive \$3,000 Slip & Fall Warranty to \$5,000 per accident. All Shoes For Crews footwear feature a patented slip-resistant sole that grips wet, greasy, and oily floors to reduce (or eliminate) slips & falls. Shoes For Crews introduces the new Steel Toe Voyager for men and women which are engineered for traction and safety with hi-tech SFC HFTM Slip-Resistant Soles. The Voyager features a steel toe cap meeting ANSI Z41.1991 standards bearing a class 75 rating, rugged 360 degree stitched down construction and reinforced rubber toe and heel covers.



**Circle No. 119**  
[www.maritimereporterinfo.com](http://www.maritimereporterinfo.com)

### SMIT

In cooperation with its Norwegian partner, pump specialist Frank Mohn, SMIT has completed a number of highly successful operations involving the recovery of oil and chemicals from vessels located on the seabed at 'greater depths.' The completion of this operation earned SMIT and Frank Mohn the internationally acclaimed Seatrade Award in the Countering Marine Pollution category.



**Circle No. 120**  
[www.maritimereporterinfo.com](http://www.maritimereporterinfo.com)

### Spence

Spence Engineering has improved the Figure 15LC Safety Valve with a new pull ring for easier testing. These ASME Section VIII UV certified valves are a cost effective solution for bulk hauling railroad and truck tank cars. Figure 15LC Safety Valves provide tight shutoff, sharp popping and closing action as well as a high degree of repeatability. Proper alignment of seating surfaces is assured by the integral inlet and body casting.



**Circle No. 121**  
[www.maritimereporterinfo.com](http://www.maritimereporterinfo.com)

### Superior-Lidgerwood-Mundy

SLM Corp. has been manufacturing a variety of deck machinery including capstans, hoists, winches, anchor windlasses and steering gears for the marine market for over 125 years. Lidgerwood has a reputation for quality and service, providing provide top notch technical services and repair parts, as well as new equipment.



**Circle No. 122**  
[www.maritimereporterinfo.com](http://www.maritimereporterinfo.com)

### Tru Marine

Tru-Marine was established in Singapore in 1977 as a general shiprepairer. In 1990, the company repositioned itself by directing its resources towards the development of turbocharger servicing, drawing on the experience and expertise of the key personnel. Today, the company is a full service provider for turbocharger servicing, capable of handling all makes and types of turbochargers. They employ innovative solutions to repair and restore damaged or worn parts, which have successfully prolonged their useful life.



**Circle No. 123**  
[www.maritimereporterinfo.com](http://www.maritimereporterinfo.com)

### Unicord

Unicord is a full line manufacturer of rope, cordage, and tying twine products for recreational marine, hardware houseware, sporting goods, commercial, industrial fisheries and OEM markets. With satellite plants in Mexico and headquartered in Chicago, Unicord is one of the fastest growing companies in the industry.



**Circle No. 124**  
[www.maritimereporterinfo.com](http://www.maritimereporterinfo.com)

### Vickers

Vickers has introduced a new biodegradable sterntube oil — Hydrox Bio 68, meeting OECD 301B specifications and non-toxic to the aquatic environment. Encompassing seven years to develop and trial, Bio 68 is emulsifiable and reduces water ingress.



**Circle No. 125**  
[www.maritimereporterinfo.com](http://www.maritimereporterinfo.com)

### Superbolt

The new edition of Superbolt's "Solutions to Bolting Problems" catalog is now available. The catalog contains technical information on mechanical stud/bolt tensioners including high temperature designs, updated installation and removal procedure and many application examples. Superbolt products retrofit your existing nuts and bolts and require only hand torque wrenches to tension bolts tighter than any other method. They eliminate the need for hydraulic wrenches, sledgehammers and heating methods commonly used.



**Circle No. 126**  
[www.maritimereporterinfo.com](http://www.maritimereporterinfo.com)

### GM Instrumentation

GM Instrumentation now offers the 0600 Dry Block Calibrator that features accuracy control, quick heat up and cool down, easy to operate and is fully portable. It is offered at the price of \$1,495. GM Instrumentation also offers a full range of pressure and temperature instrumentation to suit all marine applications.



**Circle No. 127**  
[www.maritimereporterinfo.com](http://www.maritimereporterinfo.com)

### Geislinger

Geislinger GmbH is located in Salzburg, Austria and produces torsional vibration dampers as well as elastic damping couplings for diesel and gas engines. Geislinger products are used for the propulsion of ships, powerplants, trains and hydraulic excavators. They are reducing torsional vibrations and protect the shafts, camshafts and crankshafts as well as the gears.

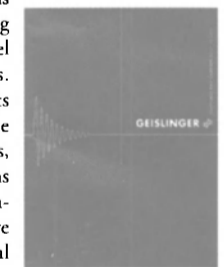

**Circle No. 128**  
[www.maritimereporterinfo.com](http://www.maritimereporterinfo.com)

### Quantic

ShipMan is a **Quantic** powerful computerized database program for tracking ship configuration, spare parts, preventive maintenance, ship technical documentation, and a shore-based warehouse. The software is user friendly and can be used on a LAN by multiple users. Quantic can easily modify the software to accommodate your specific operating requirements.



**Circle No. 129**  
[www.maritimereporterinfo.com](http://www.maritimereporterinfo.com)

### Voith

A rotating tube at the end of the fin provides a specific boundary layer influence for a flow acting on the ship's hull and a considerable increase of lift. Thus in the indirect method even higher transverse forces are reached. In the model test the principle has been successfully proven. The increase compared to a conventional Voith Water Tractor is 18 percent. A conversion requires a relatively small expenditure only.



**Circle No. 130**  
[www.maritimereporterinfo.com](http://www.maritimereporterinfo.com)

### Thermax

Thermax, non-combustible, non-toxic, marine construction boards are used worldwide for joiner bulk heads, panels, liners, ceilings, door and furniture cores. Thermax has all major regulatory body certificates (USCG, Canada, DNV et al) and meets the requirements of IMO/SOLAS resolutions. Thermax is sold, distributed, warehouse laminated and cut to size in North America by PSI.



**Circle No. 131**  
[www.maritimereporterinfo.com](http://www.maritimereporterinfo.com)

### Omnithruster

For 25 years, Omnithruster has been designated as a leading company in the development of (waterjet) maneuvering systems. Omnithruster's unique patented designs, which provide diverse maneuverability and auxiliary propulsion, have been the installation choice on vessels worldwide.

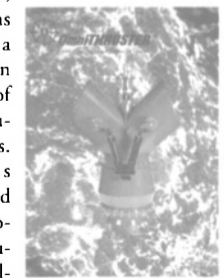

**Circle No. 132**  
[www.maritimereporterinfo.com](http://www.maritimereporterinfo.com)



**Maritime Progress**

To help owners comply with the recent revisions to SOLAS 74, Maritime Progress Ltd. has introduced a new SOLAS Training Manual. Complying with Regulation 35 of Chapter III of SOLAS 74 and its Protocols of 1978/1988 as set out in the latest SOLAS Consolidated Edition, the SOLAS Training Manual is approved by U.K. Maritime & Coastguard Agency and the Bahamian Administration. The Manual gives all members of the crew vital information on the types of lifesaving equipment provided on the ship.



**Circle No. 133**  
[www.maritimereporterinfo.com](http://www.maritimereporterinfo.com)

**In-Place Machining**

Crankshaft Grinding of Crankpins and Main Journals while the Crankshaft is in the engine, Optical and Laser measurement of Main Bearing Bores, Line Boring, Metalstitch repair of broken or cracked Cast Iron, machining Water Jackets, all types of on-board machining is accomplished by In-Place Machining Company.



**Circle No. 134**  
[www.maritimereporterinfo.com](http://www.maritimereporterinfo.com)

**Schottel**

Schottel's product range embraces 360° steerable propulsion systems rated at up to 30MW maneuvering devices, and also complete conventional propulsion packages. Through our worldwide sales and service network we offer economical and reliable solutions for every imaginable maritime application.



**Circle No. 135**  
[www.maritimereporterinfo.com](http://www.maritimereporterinfo.com)

**Alstom**

Alstom is a global specialist in energy and transport infrastructure. The "A" Series is designed to combine attributes of previous generation of DP systems with the benefits of continuous technological advancements as well as increased processing power and speed.

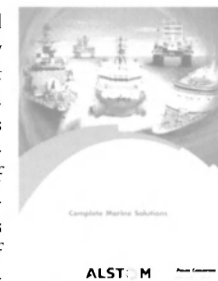

**Circle No. 136**  
[www.maritimereporterinfo.com](http://www.maritimereporterinfo.com)

**Desmond-Stephan**

Desmond-Stephan's Swirl-Off is a tool that can remove paint, rust, scale and other hard coatings from almost any hard surface. Features for this tool include: built-in safety guard, balanced design for easy operation, operates underwater, environmentally safe, fits 5/8 in. - 1 1/2 shaft, no lubrication or maintenance required, drive adaptors for 3/8 in. or .5 in. drill chuck available and cutters for all models are interchangeable and self-cleaning.



**Circle No. 137**  
[www.maritimereporterinfo.com](http://www.maritimereporterinfo.com)

**USFilter**

USFilter has released a four-page, brochure describing the company's CAPAC corrosion protection systems for fixed structures. The brochure provides a general overview of the CAPAC system, describing its history, benefits and uses. The brochure contains a description of different fixed-structure application where CAPAC systems can be beneficial: vessels; offshore production and drilling platforms; jet-ties and piles; and power plants.



**Circle No. 138**  
[www.maritimereporterinfo.com](http://www.maritimereporterinfo.com)

**Liebherr**

LIEBHERR-Werk Nenzing GmbH, located in Austria, was founded in 1976 for the purpose of designing, selling, manufacturing and providing after-sales service for ship and offshore cranes. Since then the product range has extended to include crawler cranes, as well as harbor mobile cranes. The network of Liebherr service stations throughout the world provides a continuous and reliable after-sales service for all our customers.



**Circle No. 139**  
[www.maritimereporterinfo.com](http://www.maritimereporterinfo.com)

**Hellan**

Hellan Strainers remove all types of solids (such as algae, zebra mussels, sand, grit, debris, machine cutting chips, etc.) from various fluids. They are extremely popular due to their reliability, efficient operation and cost savings. Instead of trapping solids like conventional basket strainers (which necessitate frequent basket removal for cleaning), the Hellan Strainer discharges solids from the flow without disassembly. This reduces operational and maintenance costs and permits continuous flow of fluids.



**Circle No. 140**  
[www.maritimereporterinfo.com](http://www.maritimereporterinfo.com)

**Micro-Surface**

Micro-Surface Finishing Products, Inc. manufactures Micro-Mesh, a cushioned abrasive cloth, liquids, and related products. The Micro-Mesh Kits are designed for the removal of scratches from acrylic and plastic surfaces. All of the kits contain Micro-Mesh cushioned abrasive, one or both of the polishing liquids, and easy to follow step by step instructions.



**Circle No. 141**  
[www.maritimereporterinfo.com](http://www.maritimereporterinfo.com)

**Clampco**

Clampco Products, Inc., a Wadsworth-based manufacturing company, offers its heavy duty T-bolt clamps to marine equipment designers. The clamps connect or seal hose lines and are suitable for exhaust systems, engine applications, and more. The clamps are available in marine grade 316 stainless steel. Along with the band, users may specify 316 stainless steel components such as bolts, nuts, and trunnions. For applications that don't require marine grade stainless.



**Circle No. 142**  
[www.maritimereporterinfo.com](http://www.maritimereporterinfo.com)

**Servomex**

Servomex Co., Inc., announced a contract with Lyondell Chemie Nederland B.V. for 48 of its new Servomex 2200 paramagnetic oxygen transmitters. The 2200 paramagnetic oxygen transmitters will be used on Lyondell's new POSM (Propylene Oxide Styrene Monomer) plant, due to be commissioned in the third quarter of 2003. Each Servomex 2200 paramagnetic oxygen transmitter consists of a measurement transmitter and a separate microprocessor-based control unit capable of accepting inputs from on to six transmitters.



**Circle No. 143**  
[www.maritimereporterinfo.com](http://www.maritimereporterinfo.com)

**Cross**

Cross Equipment Incorporated is a world wide equipment company, is located near the gulf coast in Houma, La. Their inventory includes a wide variety of makes and models of winches and deck equipment to meet your specific needs. The Cross Equipment Inventory includes: Winches, Levelwinds, Diesel HPU, Spooling Units, Deck Equipment, Hose /Umbilical Reels, Fairleads, Sheaves and Blocks.



**Circle No. 144**  
[www.maritimereporterinfo.com](http://www.maritimereporterinfo.com)

**Duramax**

For over 30 years, DURAMAX MARINE Johnson Commercial Dock Bumpers have been a preferred brand of extruded rubber boat and dock fenders by commercial marine professionals around the world. The Johnson brand name is associated with quality and reliability that goes beyond Duramax Marine has experience with drilling mounting holes in the Johnson Commercial Dock Bumper. Our proprietary process creates cleanly cut access and base holes, as well as, beveled or chamfered cuts on the piece ends.



**Circle No. 145**  
[www.maritimereporterinfo.com](http://www.maritimereporterinfo.com)

**Eagle**

Building on the popularity and success of the FishEasy CD sonar line, Eagle Electronics has introduced the unprecedented new FishEasy 2 that offers the power and performance of a high-end fish finder, and the affordability of a low-end unit. Touting the newest styling, display technology, and enhanced features, the FishEasy 2 for 2002 is the most economical, easiest-to-use, and best performing fish finder value available today, with a choice of three models: FishEasy 2, FishEasy 2 Portable, and Fish Easy 2T with water surface temperature sensor.



**Circle No. 146**  
[www.maritimereporterinfo.com](http://www.maritimereporterinfo.com)

**Inmarsat**

Inmarsat Ltd., has approved Fleet F77, its new maritime Mobile ISDN and Mobile Packet Data service, for commercial service. Type-approved hardware is now available for use from manufacturer Thrane & Thrane, and Telenor and Xantic Land Earth Stations have been authorized in all four ocean regions. Fleet F77 combines the high quality and speed of a 64kbit/s Mobile ISDN service with the world's first global, high-speed, maritime Mobile Packet Data service via satellite.



**Circle No. 147**  
[www.maritimereporterinfo.com](http://www.maritimereporterinfo.com)

**Hamilton**

With over 30,000 waterjet units installed around the world, Hamilton Jet represents the latest in waterjet technology. They are the preferred choice for the efficient propulsion of a wide range of high speed work and patrol boats, fast passenger ferries, crew boats, fire boats, fishing vessels and landing barges.



**Circle No. 148**  
[www.maritimereporterinfo.com](http://www.maritimereporterinfo.com)





# INFORMATION

**S H O W C A S E**

**GET FREE INFORMATION ONLINE at: [www.maritimereporterinfo.com](http://www.maritimereporterinfo.com)**

**Get Free Information Fast**

Circle the appropriate Reader Service Number  
on the opposite page or visit  
[www.maritimereporterinfo.com](http://www.maritimereporterinfo.com)



Page	Advertiser	Product	R/S#	Page	Advertiser	Product	R/S#
63	2002 Global Marine Directory	CD-Rom	353	52G	MAN B&W Diesel AG	turbochargers	258
6	ABB Turbosystems AG	turbochargers	200	44	Mapeco	couplings	259
37	Air Products AS	gas generation systems	201	77	Marine Exhaust Systems of Alabama	water cooled manifolds	260
29	Airvac	vacuum systems	202	20	Mariso USA	spare parts	261
8	Albacore Research Ltd.	CAD/CAM	203	77	Maritime Associates	marine and offshore signage	262
53	Alstom Power & Conversion	electric propulsion pod	204	8	Martek Marine Blinds Ltd.	bridge sunscreens	331
25	American Vulkan	couplings	205	84	Mascoat Products	coatings/marine insulation	263
89	Ameri-Force	skilled laborers	329	44	MetalCraft Marine Inc.	aluminum boat builders	346
70	Anchor Lamina	portable hydraulic drilling equipment	206	74	Mi-Jack Products	container handling	345
4	Anchor Marine	marine equipment	207	55	MITAGS	training and education	264
84	Arion International Inc.	marine thermal imaging	208	58	MMC Int'l	tank gauging tapes	265
52D	Auramarine Ltd.	power plant systems	209	52	Motor-Service AB	diesel engine parts	266
29	BAE Systems	windows & wipers	210	14	Motor-Services Hugo Stamp	diesel engine repairs	267
23	Ballast Technologies	ballast	211	64	Napier Turbochargers	turbochargers	352
51	Benjamin R. Vickers & Son Ltd.	lubricants	212	77	Nautican	nozzles	343
38	Boll Filter Corp.	filters	213	47	NautiCast AG	AIS transponder	337
52D	Brunvoll A/S	thruster systems	214	50	NLB Corp.	surface prep equipment	349
36	C.M. Hammar AB	life saving equipment	215	87	NOAA Office of Coast Survey	navigation charts	269
39	Cadmatic	CAD/CAM	216	52A	North American Marine Jet	jet products	270
76	Calhoun MEBA Engineering School	engineering school	347	52E	Nya Berg Propulsion AB	propulsion	271
76	Capt. R.J. Underhill & Assocs.	consultants	217	38	O.W.Bunker & Trading	bunkering company	272
68	Cashman Equipment	barge rentals	218	18	Oceangrafix	charts	326
25	Chartco	navigational chart updates	319	19	Offshore Communications 2002	exhibition	273
42	C-Map Commercial	electronic charts	336	56	Oilfield Electric Marine	water cooled AC drives	318
72	Companion Products	oil safe professional lubrication systems	350	86	Omnitruster Inc.	thrusters	274
C3	Cooper Bearing	bearings	219	68	Orkot	bearings	275
64	Cospolich Refrigeration	refrigeration	351	4	Panduit Corp.	electrical products	276
C2	Craft Bearings	bearings	220	76	Philadelphia Resins	coating systems	277
8	Creative Systems	software	221	80	Pipe Painter	products & services	278
44	CSD North America	sealing systems	339	79	Plastic Pplings	navigational marker	279
45	Curacao Drydock Co.	ship repair yard	222	80	Redland Genstar	ballast crete	280
33	Dayton T. Brown	shipboard testing	223	35	Restech Norway A/S	pneumatic line throwers	281
31	The Delamar Company	slade fluid sealing	303	23	Resurgence Software Inc.	software systems	342
3	Detroit Diesel	diesel engines	224	32	Ritchie Bros. Auctioneers	auction	316
26	Duramax	heat exchangers	317	16	RTM Star Center	training	268
31	Electronic Marine Systems	tank level indicators	225	13	Rutter Technologies	voyage data recorders	330
33	Electronic Marine Systems	tank level indicators	226	51	RWO GMBH	water technology	282
35	Electronic Marine Systems	tank level indicators	227	7	Rydex: An Immarsat Venture	marine data solutions	283
37	Electronic Marine Systems	tank level indicators	228	42	Saab Marine Electronics	marine electronics	284
81	ElectroWave USA	electronic monitoring/control systems	328	19	Sasakura Engineering	fresh water generator	285
2	Envirovac	sanitation systems	229	54	Schottel Inc.	propulsion	286
85	Flagship Marine	marine air conditioners	231	80	Schuyler Rubber Co.	fenders	287
52	Flow International	water jet cleaning	335	76	Sea Ark Marine	boatbuilders	327
77	G.J. Wortelboer	chains	232	5	Sea Tel Inc.	communications	288
86	G.R. Bowler	control/monitoring systems	340	90	Seatrade Cruise Shipping CMP	convention	315
41	GE Marine	engines	338	59	Seaward Intl.	fenders	289
52C	Geislinger	couplings	233	67	SENECO	shipbuilding & repair	356
36	Georgia Pacific	Dens-Marine bulkhead panel	322	37	Serck Como GMBH	fresh water generators	290
28	GMT Electronics	marine electronics	341	88	Ship Repair & Conversion Infoma	exhibition	334
12	Goltens Marine Co.	diesel engine repair	234	35	ShipTech A/S	marine consultant	291
52H	Haaglund Drives AB	drive systems	235	10	Skookum	rigging products	292
20	Harbormaster Marine	propulsion systems	236	75	Sohre Turbomachinery	grounding brushes	293
76	Harrington Marine	kort nozzles	237	56	Spurs Marine	line and net cutters	294
24	Hatteland Display	maritime multi display	238	54	Stork Bronswerk	air conditioning/refrigeration	295
25	Headhunter Inc.	toilets	325	30	Stork-Kwant	electric shaft systems	296
4	Hellan Strainer	filtration equipment	239	65	Standard Horizon	marine electronics	355
75	Hepworth Marine	windscreen/window wipers	240	82	Stratos	satellite communications	297
67	Hernis Scan Systems A/S	closed circuit television	354	52	Superbolt	bolts	298
12	IFTSA/Fire Service Programs	fire fighting manuals	241	31	Superior Energies	insulation	299
27	Incat Australia Pty. Ltd.	fast vessels	242	21	Superior Lidgerwood Mundy	deck mahinery	300
23	In-Place Machining	crankshaft repair	243	52F	Tano Corp	propulsion control systems	333
81	Inventory Locator Service	parts & locator service	348	24	Taylormade Environmental	air conditioning	301
85	Island Boats	boat builders	244	80	Technofibre Pte. Ltd.	lifeboat and davit maintenance	320
15	IZAR	shipbuilders	245	49	Telenor Broadband	satellite communications	302
17	Japan Radio	communications	257	16	Thermax	bulkhead panels	304
75	Jastram Engineering	steering systems	246	69	Thordon Bearings Inc.	bearings	305
30	Jeamar Winches	winches	247	47	Thrane & Thrane A/S	communications	306
25	Jesse Engineering	flanges	321	11	Urethane Products	foam filled fenders	307
28	John J. McMullen	naval architects	248	1	USMMA	training	308
49	Jotron Electronics	marine electronics	249	43	Voith Schiffstechnik GMBH & Co.KG	drive systems	309
80	Kaplan & Assocs.	propulsion parts & products	250	57	Wartsila Corporation	propulsion	310
C4	Karl Senner	marine propulsion equipment	251	52F	Wartsila Lips	propulsion systems	324
52B	Kawasaki Heavy Industries	marine equipment	252	10	Water Weights	load management solutions	311
70	King Engineering	tank leveling	253	75	Waterman Supply	marine equipment	312
8	LC Doane	lighting systems	254	77	Western Machine Works	deck machinery	313
61	L-3 Communications	VDR-AIS-VHF	332	73	Willard Marine	RIBS	344
21	Lantec	winches	323	10	Wolong International Pte.Ltd.	lifeboat manufacturers	230
9	Leslie Controls	valves	255	10	Wynn Marine Ltd.	windscreen/window wipers	314
71	Liebherr-Werk Nenzing GMBH	marine cranes	256				

The listings above are an editorial service provided for the convenience of our readers.

# THE MARINE MART

The Classified  
and Employment Section



## Products & Services

### DAVITS

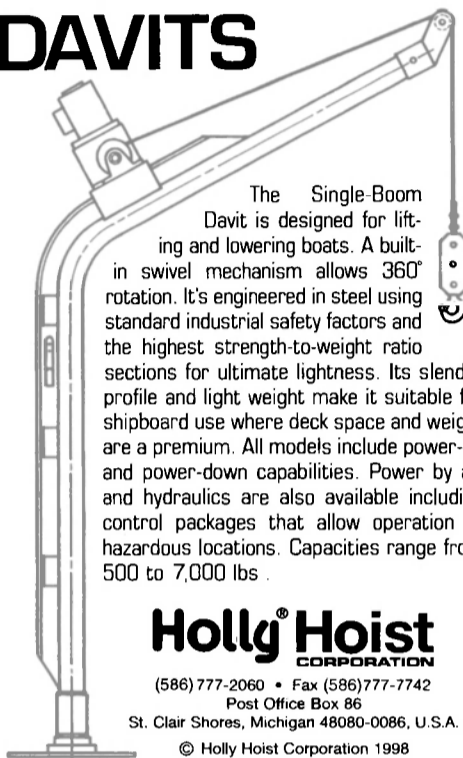

The Single Boom Davit is designed for lifting and lowering boats. A built-in swivel mechanism allows 360° rotation. It's engineered in steel using standard industrial safety factors and the highest strength-to-weight ratio sections for ultimate lightness. Its slender profile and light weight make it suitable for shipboard use where deck space and weight are a premium. All models include power-up and power-down capabilities. Power by air and hydraulics are also available including control packages that allow operation at hazardous locations. Capacities range from 500 to 7,000 lbs.

#### Holly® Hoist CORPORATION

(586) 777-2060 • Fax (586) 777-7742  
Post Office Box 86  
St. Clair Shores, Michigan 48080-0086, U.S.A.  
© Holly Hoist Corporation 1998

**NOW REQUIRED:**  
A Shipping Vessel Equipped with Fixed Pitch Propellers Must Have A Propeller Speed and Direction Indicator For each Shaft  
U.S.C.G. 46 CFR113.37-5

### DIRECTIONAL SHAFT TACHOMETER



Model 8402-DIR

- Guaranteed Accurate To 1 RPM
- Withstands Severe Marine Use
- Economical & Reliable
- Other Applications For Engine & Shaft

"Call For Free Brochure"

#### AETNA ENGINEERING

EXPLOX - XINTEX, Inc.

800-776-7962 616-735-9380

616-735-9381 Fax

www.aetnaengineering.com

e-mail: aetna@fireboy-xintex.com

### Tired of nautical reproductions



Maritifacts has only **authentic marine collectibles** rescued from scrapped ships: navigation lamps, sextants, clocks, bells, barometers, flags, binnacles, telegraphs, portholes & more. Current Brochure - \$1.00.

www.martifacts.com / maritifacts@aol.com

#### MARTIFACTS, INC.

P.O. Box 350190 Jacksonville, FL 32235-0190

Phone/Fax: (904) 645-0150

### LOWER OPERATING COST

Lifetime Warranty



- More Power
- Less Smoke
- Save Fuel

#### CLEANS ENTIRE FUEL SYSTEM

Fuel Optimization Certified by EPA Approved Lab  
Available through Major Engine Distributors

CARB# D-538

**ALGAEX** 877-425-4239  
www.algae-x.net  
Fuel Optimization

Tel: 239-463-0607 Fax: 941-463-7855 algae-x@algae-x.net

### STCW

Practical and Written

www.

SeaSchool.com

Coast Guard  
Approved  
Courses



800-237-8663

### TANKS Custom Fuel Cell Bladder

Diesel or Gas

Tanks

- Impact Resistant
- Non-Expanding
- Vibration Proof
- Lightweight
- Fully Baffled

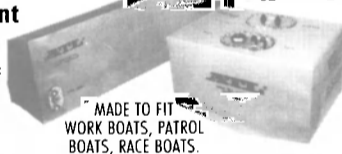

MADE TO FIT  
WORK BOATS, PATROL  
BOATS, RACE BOATS.

TOLL FREE 800-526-5330

**AERO TEC LABORATORIES, Inc.**  
Spear Road Industrial Park, Ramsey, NJ 07446-1251 USA  
Phone: 201-825-1400 Fax: 201-825-1962

Bry-Air Dehumidifiers Sales & Rentals Available From:

### MARINE DEHUMIDIFICATION CO., INC.

Bry-Air, Inc., Manufacturers of Complete Environmental Control Systems, Manufacturers' Representatives. Serving Manufacturers, Industrial Contractors and other firms in both Land and Marine Industries.

23 Upton Street  
Peabody, MA 01960

Tel: 978-927-1680

978-532-5130

Fax: 978-977-9182

www.marinedehumidification.com

E-mail: MARINEDH@aol.com

We also rent Desiccant Dehumidifiers, Air Conditioners, Heaters, Dust Collectors and Flexible Ducting.



### Barataria Lofting Company, Inc.

"Professional Lofting Services"

Phone/Fax: (504) 340-5859

1616 Barataria, Blvd. suite 4  
Marrero, LA 70072

Want the very  
latest maritime  
news e-mailed  
to you daily?  
It's one click  
away at ...

MaritimeToday.com

### JON M. LISS ASSOCIATES, INC.

63 BOVET ROAD NO. 503 • San Mateo California 94402



NAVY STANDARD  
VANEAXIAL  
FANS  
Delivery  
From  
Stock

(650) 573-9191

Fax (650) 572-8458

jon411@pacbell.net

### Marine Video Systems

Security - Surveillance - Convenience

Monitors - \$119.95  
Waterproof cameras - \$189.00  
Flat Screen Monitors - \$349.00  
Time Lapse & Real Time

www.flagshipvideo.com



Phone: 772-283-1609 Fax: 772-283-4611  
Watts: 800-316-6426 Stuart, Florida - USA



# THE MARINE MART

The Classified  
and Employment Section



## Products & Services

**CAMAR International Corp.**  
186 Prescott St. Worcester MA 01605

**FMS REPAIR PARTS**  
For Ex-USN Ships in Foreign Navies



The most complete stock of MILSPEC replacement parts and components for:

- Blowers & Compressors
- Steam Turbines
- Pumps
- Steam Valves
- Steam Boilers

Rotating Equipment Specialists

For Sales, Service and Support Call  
(800) 352-7629  
or fax to (508) 752-5687

**\$ GREEN ONE INC \$**  
INNOVATIVE FINANCIAL SOLUTIONS

- \*MARINE FINANCING
- \*MARINE CONSTRUCTION LOANS
- \*EQUIPMENT LEASING
- \*FACTORING

Phone: 251-626-7490  
Fax: 251-625-4729  
www.GreenOneInc.com

**Peck & Hale** 180 Division Avenue, West Sayville NY 11796  
Tel: (631) 589-2510 Fax: (631) 589-2925  
Web Site: www.peckhale.com  
e-mail: sales@peckhale.com

**Release-A-Matic H44 R.A.M. Hook**

Features:

- Quick disconnect
- Remote release or disengagement
- Place loads where access is restricted
- Saves Manpower
- Wide range of angles of release

101 Applications!!

- Towing
- Fishing
- Maritime
- Boating
- Construction
- Lifeboats
- Material Handling
- Laboratory

Specifications:

Material: Heat Treated Forged Steel  
Finish: Zinc or Cres.

Strength:	S.W.L.	M B S
H44-3L	2,000 lbs.	8,000 lbs.
H44-3	4,500 lbs.	18,000 lbs.
H44-8	18,000 lbs.	71,700 lbs.

Peck & Hale is your Full Service Cargo Securing Systems and Equipment Supplier!  
Military • Maritime • Railroad • Aircraft Applications  
Sockets • Hi-shock Chain • Wire & Web Lashing Tiedowns

**CONSTRUCTION PACKAGES**  
BOAT CONSTRUCTION KITS  
COMPUTER LOFTING PLATE PROCESSING

Advance Fabricating, Inc. Galveston, TX (281) 414-5550 advancefab.com



### MARINE PAINT COMPANY FOR SALE

EAST COAST MARINE PAINT COMPANY WITH WORLD WIDE NETWORK, SUPPLYING OCEAN GOING VESSELS, OFFERS GOOD OPPORTUNITY FOR MANUFACTURER WANTING TO EXPAND INTO THE MARINE MARKET OR FOR AN INDIVIDUAL INTERESTED IN THE MARINE MARKET.

PLEASE RESPOND TO:  
REAGAN COMMUNICATIONS  
50 LEXINGTON AVE. STE 290  
NEW YORK, NY 10010

**HP International, Inc.**  
4932 Distribution Dr. Tampa, FL 33605 USA  
Tel: (813) 247-2110 Fax: (813) 247-2325  
Email: parts@hpinternational.com  
Website: www.hpinternational.com

**WE SUPPLY SPARE PARTS FOR:**

<b>ABB/VTR</b>	<b>Daihatsu</b>	<b>MAN</b>
<b>Alfa Laval</b>	<b>Detroit</b>	<b>Mitsubishi</b>
<b>Atlas Copco</b>	<b>Deutz</b>	<b>Paxman</b>
<b>Caterpillar</b>	<b>Donaldson</b>	<b>Sulzer</b>
<b>Carrier</b>	<b>Hamworthy</b>	<b>Yanmar</b>
<b>Cummins</b>	<b>Ingersoll-Rand</b>	<b>Quincy</b>

**MARINE INCINERATORS**

Burn shipboard waste and sludge in rugged and efficient THERM-TEC Mariner incinerators. The first and only US built, IMO, USCG, ABS approved equipment. We also supply leased containerized incineration plants for open deck use.

THERM-TEC Inc. www.thermtecmarine.com  
e-mail: carolina@teleport.com Phone: 503-978-0863

**IC<sup>3</sup> SHAFT HORSEPOWER MEASUREMENT**  
The Digital Torque Meter System

- Fiber Optic Sensors
- Accurate & Repeatable
- Simple Installation
- Easy Calibration
- HP & Engine Hours
- Competitively Priced
- Sea Trials
- Purchase or Lease

The DTMS measures shaft horsepower, torque & RPM. Calibration is accomplished by turning gear at dock or coasting the shaft down at sea while using the step by step manual. The system consists of an electronic display/enclosure, fiber optic cables, stationary sensors & interrupters, and interrupter rings that flex over the shaft. We can interface to other instrumentation and customize as required. The DTMS can be sold either as a permanent or portable system.

Instruments, Computers & Controls, Corp.  
TEL 603-628-3900 / FAX 603-628-2884 Email RHICC@aol.com

**REPLACEMENT PARTS FOR:**

SKL/DMR • Paxman • Sulzer  
Fairbanks • MTU  
Fuel Injection Parts • Superior • GMT  
Alco • Cooper • Delaval Enterprise

PHONE: 719-227-1821  
FAX: 719-227-7498

**APPLIED ENERGY CORP**

EMAIL: Applied@JTP.com  
WEBSITE: www.JTP.com/Applied  
1443 GUNNISON ST. • COLORADO SPRINGS, CO 80909

**A.R. LARSEN COMPANY INC.**

www.marinegalley.com

Excellence in Food Service Equipment & Services to the MARINE INDUSTRY...around the globe.

MARINE GALLEY DESIGN  
EQUIPMENT & APPLIANCES  
CUSTOM FABRICATION • INSTALLATION  
JOINER SYSTEMS  
FIXTURES & FURNISHINGS

1-800-735-7286

(425) 861-8868 • Fax: (425) 861-8668  
arlarsenco@yahoo.com • Redmond, WA 98073-0088

Our products meet or exceed marine industry regulations, standards and requirements.

**TOP DOLLAR PAID BARGES WANTED SHIPS, TUGS, ALUMINUM BOATS FOR SCRAP METAL.**

**BAY BRIDGE ENTERPRISES LLC**  
JACOBSON METAL COMPANY IS BUYING ALL SCRAP METAL AND REUSABLE EQUIPMENT.

PH: (757) 543- 2006  
FX: (757) 543- 6632  
Ask for- Mario Mazza, Tim Mullane

4300 BUELL St.  
CHESAPEAKE, VA. 23324

There's only one thing with a stronger international presence than MARITIME REPORTER. Empower your ad with superior circulation. Call: 212-477-6700



THE MARITIME GROUP  
118 East 25th Street, New York, NY 10010  
Tel: 212-477-6700, Fax: 212-254-6271, E-mail: info@marinelink.com

# THE MARINE MART

The Classified  
and Employment Section



## Vessels for Sale/Charter

### FOR SALE



Canadian Ro/Ro vessel, 1977 built, loa 101.66 m, beam 17.1 m, 2 X 4200 hp Pielsticks, 2 variable pitch propellers, 2 X 500 hp bow thrusters, 1 set stabilizers, 3 generators @ 770 kw 440 v, 45 crew accommodation, stern and bow doors, passenger deck. Could provide drydocking, upgrading and conversion

**AS IS WHERE IS**  
**\$ 3,000,000 US.**

**For more information contact John Mooney**  
**VERREAULT NAVIGATION Inc.**  
**Tel. 418-729-3733 Fax. 418-729-3054**



**FOR SALE / CHARTER**  
**(4) STEEL LIQUID CARGO BARGES**

**Size:** 120' x 33' x 10.5' \* 6 compartments mid-body  
**Liquid Capacity:** Approx. 188,416 Gallons  
**Deck Capacity:** 578 L Tons (piping below deck)  
**Built:** 1989 \* ABS LL org issued \* Located Pier 96 SF, CA  
**Condition:** Excellent Unused condition  
**Price and specifications available upon request**  
**richr@rasmussenco.com - Phone: (800) 227-7920**

### 125' X 26' Commercial Aluminum High Speed Hull

Powered by:  
three V-12 MTU Diesels  
Two 6-71 General Motors  
Generators

Previously Certified for Home  
Trades I 262 Passengers

The vessel is currently lying in Vancouver, BC. out of the water and a reconfiguration and refit of its accommodations is under way. At this time a wide range of options exist for the redevelopment of the vessel.

Price: \$849,000 Canadian

Ideal Day Charter  
excursion Tour Boat

Located in Vancouver, BC Canada  
Contact: John Roland 1-250-888-5516  
Email: rjroland2001@yahoo.com  
View pictures & survey at [www.grandyachts.ca](http://www.grandyachts.ca)

**Grand Yachts Inc.**  
**Commercial Division**

### 2-1000 HP MTU DIESEL ENGINES

under 150 hours/yacht  
takeouts "w/2 - 1 Gears"  
\$105,000.00 . Also available  
2 Arneson # 12 Surface Drives

**4 0 1 - 8 6 2 - 2 6 6 6**

### (2) New Double Drum - Diesel Winches



**Anchor / Spud / Puller**  
**Model AW1500**  
**150,000# 1st layer SLP**  
**3,000' 1-1/2" W/R Cap / drum**  
**6-71 GM-TD/TC**  
**\$225,000.00 / ea.**



**(1) Crewboat**  
**29' Alum, GM 6-71**  
**\$28,000.00**

**RASMUSSEN EQUIPMENT COMPANY**  
(800) 227-7920 • info@rasmussenco.com • www.rasmussenco.com



**51' Steel WorkBoat 1981** - Twin 8V92  
Detroits, 5000 hours, 2 - 12 kw Onans.  
Just completed rework on props,  
shafts, cutlasses, all other mechanical.  
New hydraulic anchor winch, chain,  
cable, Bruce anchor, VHF. UHF and  
value surveyed @\$249K. Asking \$185K.  
Located Modutech Marine Tacoma, WA  
**253-272-9319**



### Specializing In Barges



- ◆ Single or Double Hull, Inland or Ocean-Going
  - ◆ Design, Construction & Modification
  - ◆ Chartering, Sales & Brokerage
- Ask for Bill Gobel or Jack Breshears  
503-228-8891 1-800-547-9259

3121 SW Moody Avenue, Portland, Oregon 97201

# THE MARINE MART

The Classified  
and Employment Section



## Employment/Recruitment

### Anchor Your Career At ENSCO Marine

ENSCO Marine has one of the most diversified fleets of offshore supply vessels in the Gulf of Mexico.

We offer a 14 on/14 off rotation, competitive salaries and an employee benefits package which includes medical with prescription drug card, dental, life insurance, AD&D, LTD, 401(k) savings, profit sharing, free uniforms and company paid training for license upgrades including all CG required documentation and STCW certification.

ENSCO Marine is currently seeking:

- 500 & 1600 Ton Mates
- DDE 4000 H.P. or greater
- Licensed Chief Engineers
- QMEDS
- Able Bodied Seamen
- Ordinary Seaman

Contact the HR Department at:  
**800-227-9583; Fax 337-837-4087**  
e-mail [jobs@enscou.com](mailto:jobs@enscou.com)  
or send resume to 620 Moulin Road  
Broussard, Louisiana 70518



We are an Equal Opportunity  
Employer M/F/D/V

[www.enscou.com](http://www.enscou.com)

N



E

### Keough Associates

Since 1975, providing Professional Search and Recruitment Services in areas of Middle and Senior Management, Technical Support, Engineering, Operations, etc., to the Maritime Industry

**Michael R. Keough, CPC**  
PH: (718) 979-8698  
FAX: (718) 667-8347

### BOAT JOB LISTINGS UPDATING

DAILY  
CALL 24 HOUR  
MARINE JOB HOTLINE  
504-889-JOBS (5627)



### Positions Available:

**Captains • Mates  
Pilots • Engineers  
Tankerman • AB's  
QMED's • OS's**

ATT: All boat companies. When you are in need and your boat can't move, call for all crew members - trip or permanent. We are here for you.

**BUCCANEER**



**CREWING**

**Buccaneer Crewing**  
The Offshore Employment Specialists  
**866-675-6300**

**Fax: 251-442-3696**  
[hr@buccaneercrewing.com](mailto:hr@buccaneercrewing.com)  
[www.buccaneercrewing.com](http://www.buccaneercrewing.com)

**TECO**

### OCEAN SHIPPING

TECO OCEAN SHIPPING has the largest U.S.-flag oceangoing fleet specializing in dry bulk cargo. We boast a fleet of conventional tug-barge units, ITBs and ships.

As a TECO Ocean Shipping team member, you'll enjoy the following benefits:

- Pay for training
- Medical/dental benefits
- Paid holidays
- Tuition reimbursement program for approved courses
- 401k Savings Plan with a company match
- Performance-based incentive compensation program
- Retirement plan
- Paid travel

Experienced mariners, both deck and engine, are encouraged to apply.

Contact: TECO Ocean Shipping - Marine Human Resources  
2101 GATX Drive, Second Floor  
Tampa, FL 33605  
Phone: 813-209-4261  
Fax: 813-677-5514  
E-mail: [cramstrong@tecoenergy.com](mailto:cramstrong@tecoenergy.com)

EOE



A 24-hour dispatch passenger and Freight transportation company serving the Puget Sound Area since 1988, has a current opening in Port Angeles, Washington for an experienced  
**Logistics Supervisor/ Dispatcher/Scheduler**  
for our Puget Sound operations.

We are seeking a sales oriented, self-motivated individual with the ability to handle multiple tasks simultaneously, making decisions quickly and accurately, while working in a highly interactive, fast paced, ever-changing environment.

The successful candidate will report directly to the Company President. Responsibilities include coordination of customer and ships' needs by scheduling launch/vessel crews, vessels, and equipment for multiple Port locations and companies. Inform crews of their scheduled destination and launch time. Keeps highly detailed records of all transactions. Reviews crew logs to ensure accuracy. Monitors and reports progress of inbound/outbound freight. Maintains inventory log. Maintains control log of all communications received. Follow-up details/record keeping is mandatory for multitude of jobs. Individual must be comfortable with and have strong experience-utilizing multi-line phones, fax machines, two-way radios, and pagers. Must have strong PC/software skills. Creative problem solving skills, interpersonal/organizational skills and outstanding communication skills with ability to effectively communicate with customers, management and staff both orally and in writing.

Ability to project professional image to both customers and staff is imperative.

Available to work various shifts and flexible hours required.

Knowledge of D.O.T. regulations preferred.

Background in the maritime industry required

Competitive Salary and Benefits Package:

Medical, dental, vision, retirement

For additional information [www.arrowlaunch.com](http://www.arrowlaunch.com)

Email: resume with salary requirement to:

[pat@arrowlaunch.com](mailto:pat@arrowlaunch.com) or mail to

Arrow Launch Service

Att: Human Resources Director

P.O. Box 2376

Port Angeles, WA 98362

EOE/M/F/V/D

### WANTED

Motivated DECK & ENGINE LICENSED & UNLICENSED PERSONNEL

to fill ongoing VOLUNTARY positions.

International CHRISTIAN nonprofit charity, North American Ships Office of LOGOS II & DOULOS.

Toll Free: 866-667-4477

Email: [info@naso.shipsoffice.org](mailto:info@naso.shipsoffice.org)

Websites: [www.mvdoulos.org](http://www.mvdoulos.org) or

[www.mvlogos2.org](http://www.mvlogos2.org)



### Marine Crew Needed

Masters 1600 Ton

Mates 1600 Ton

Chief Engineers Unlimited H.P.

1<sup>st</sup> and 2<sup>nd</sup> Asst Engineers

QMED.s

ABs

USCG License - STCW 95 endorsement

For a new passenger High Speed Ferry/Casino Boat that will be based in Savannah, GA Starting 10/02

Please submit resume to:

Party Line Cruise Company

[partvcl@bellsouth.net](mailto:partvcl@bellsouth.net)

or Call: 1-800-partycl (727-8925)

### Engineering Manager/Superintendent

Sabine Transportation is seeking an Engineering Manager/Superintendent to join our engineering team.

The ideal candidate should be:

\*Well versed in all aspects of marine engineering for both steam and diesel ships

\*Computer literate

\*Familiarity with ABS SafeNet program a plus

\*Willing to relocate

We offer fair pay and a comprehensive benefit package

Apply in writing to: Sabine Transportation Company

HR Director

500 Stickle Drive NE

Cedar Rapids, IA 52401

Or online to [ianc@stickle.com](mailto:ianc@stickle.com)

EOE. Applications no longer accepted after  
September 30, 2002





## Employment/Recruitment



[www.haltermarine.com](http://www.haltermarine.com)

Visit our website for profile and current activities

### VESSEL DESIGN ENGINEERS:

Naval Architect-Hull  
Structural Engineer-Marine  
Marine Mechanical Engineer

### NAVAL ARCHITECT HULL

BS Degree in Naval Architecture required with minimum 5-7 years experience. Experience and expertise must include schedule compliance, specification compliance, regulatory requirements and standard practices, technical data and calculations, sketches, preliminary lay-outs. Knowledge of ABS, USCG & SOLAS rules required.

### STRUCTURAL ENGINEER VESSEL DESIGN

BS Degree required with minimum 5-7 years commercial vessel design. Experience must include development of structural calculations and structural ship design, layout and integration sketches, and equipment foundations. Must have knowledge of ABS rules.

### MECHANICAL ENGINEER VESSEL DESIGN

Accredited BS Marine/Mechanical Engineering with 5-10 years mechanical engineering experience - prefer marine design experience on new commercial vessels. Design team supervisory experience required. Knowledge of ABS, USCG & SOLAS rules. Must have ability to develop machinery designs from ship specifications and Regulatory requirements.

*Competitive Salary and Benefit Package*

Attn: Recruiter-MR  
Halter Marine  
P.O. Box 3029, Gulfport, MS 39505  
Email: [hr@haltermarine.com](mailto:hr@haltermarine.com) Fax: 228-897-4949  
EOE/AAP

## BENDER

### NOW HIRING!

**A/B's & O/S's**  
OVER 50 POSITIONS AVAILABLE

**100 TON MASTERS**  
IMMEDIATE JOB OPENINGS

**1600 TON MASTERS**  
CALL TODAY FOR JOB OFFERS

**LICENSED ENGINEERS**  
\$3000 SIGNING BONUS

**QMED'S & OILERS**  
EAST COAST, GULF, CARRIBEAN

CALL TOLL FREE 1-888-824-1626

APPLY ONLINE  
[www.bendermarine.com](http://www.bendermarine.com)  
[www.maritimejobsonline.com](http://www.maritimejobsonline.com)



## FAIRFIELD INDUSTRIES

Fairfield is known the world over for its development and use of advanced technology for both acquisition and processing of seismic data utilized in the exploration of oil and gas. Specializing in acquisition and data handling, Fairfield designs and manufactures seismic data acquisition systems, operates crews to acquire seismic data, processes a wide variety of data, and licenses non-exclusive seismic data to oil and gas companies. Our Marine field operations are based out of Lafayette, LA.

The departure point is Lafayette, LA. Currently we are working off of the coast of Texas & Louisiana.

Our Marine crew works a 28/28 schedule with accrued paid time off. We believe our day rates and attractive schedule is very competitive. In addition Fairfield offers an excellent benefits package including life, health, dental, vision, long-term disability and 401(k) program.

#### Frequently recruited positions are listed below

Job Title	Starting Day Rate & Annualized Rate	
A/B Seaman (USCG MMD)	\$95-100/day	\$ 34,675
Oiler/QMED (USCG MMD)	\$85-115/day	\$ 31,025
Chief Engineer/DDE (USCG Unlim. HP)	\$158/day	\$ 57,670
Utility/Galley Hand (USCG MMD)	\$72/day	\$ 26,280
Marine Diesel Mechanic	\$92/day	\$ 33,580
Mate (USCG Lic 500+ tons)	\$145/day	\$ 52,925
Compressor Mechanic (2000+ psi)	\$132/day	\$ 48,140
Air Gun Mechanic	\$92/day	\$ 33,580
Cook (USCG MMD)	\$90/day	\$ 32,850

#### Previous Seismic (OBC) experience is a plus.

Qualified applicants are encouraged to contact recruiter for more information on open positions. You can forward a resume & salary history (include schedule) to [jhodge@fairfield.com](mailto:jhodge@fairfield.com) or fax it to Jeff Hodge - Human Resources/Field Recruiter @ 337.232.2313. Screening includes completion of Drug test, background check, physical & agility test.

Questions? Call 800.231.9809 ext. 7642 for Jeff Hodge - Human Resources/Field Recruiter.  
Fairfield Capabilities: <http://www.fairfield.com/Acquisitionhome.html>

Fairfield Industries is an equal opportunity employer.

### BALTIMORE MARINE INDUSTRIES

#### Vice President of Production

Join a dynamic and successful company. The ideal candidate will be highly motivated and able to work independently, as well as in a team environment. Applicants must have a graduate degree in Naval Architecture and/or Marine Engineering and a minimum of ten years experience in ship construction or ship repair activities.

Please apply in writing to:  
Cal Thompson

**Baltimore Marine Industries**  
600 Shipyard Road  
Baltimore, MD 21219-1023 USA  
e-mail [dc@baltimoremarine.com](mailto:dc@baltimoremarine.com)

All applications will be treated in strict confidence.

### SALES MANAGER LIQUID POLLUTION CONTROL

Industry leading producer of oily water separation and biofouling equipment for both marine & land based applications seeking marketing & sales professional with relevant experience. Ability to manage & grow established rep & distributor base. Northern NJ location. Only applicants willing to relocate apply. Resume & salary requirements to:

P.O. Box 11  
Rockaway, NJ 07866

# THE MARINE MART

The Classified  
and Employment Section



## Employment/Recruitment

## Professional

### L & L EMPLOYMENT

*Immediate Openings* for AB'S & O/S.  
Company paid fee for 100 TON CAPT &  
DDE's. Calling all EXPERIENCED TUG  
CAPTAINS. OUTV's. *Paid Trans. Top  
Pay for 200 TON CAPT - 1600 TON  
CAPT/MATES. CHIEF, ASST. ENG -  
3RD ASST ENG . Excellent Pay.  
QMED'S, TANKMAN, DH'S, UNI ENG*  
*Need Immediately.*

**888-580-9600**



www.lavtec.com  
Built with seamless fiberglass for a completely watertight structure.  
Luxury, custom and standard designs are available. factory direct.  
Delivered completely assembled, plumbed, and wired  
Made in USA with Coast Guard approved composite materials.  
AMTECH CORPORATION, Yelm WA. 360-458-3999. johnr@amtechcorp.com



STOCKS IN MAJOR U.S. PORTS  
ASSOCIATED COMPANIES IN MEXICO,  
EUROPE AND THE FAR EAST  
21 CHARLES ST., WESTPORT, CT 06880  
Ph: 203-226-5200 Fax: 203-226-5246  
ANKERPAINT@aol.com

### BAYFRONT MARINE, INC.

EXPERT WORLDWIDE VESSEL DELIVERY SERVICE  
EXPERIENCED PROFESSIONALS  
Licensed  
Masters, Engineers and Crews  
Call Mel or Diane Longo (904) 824-8970

### B&A MARINE CO., INC.

COMPLETE TOPSIDE REPAIRS  
• Full Machine and Electrical Shops  
• Daihatsu Diesel Authorized Service & Parts  
• Shipfitting, Pipefitting, Certified Welding, Diesel Repairs  
• Motor and Generator Rewinding, Dynamic Balancing  
• Pump Repairs and Custom Fabrications  
• Experienced Riding Crews for all Trades  
75 Huntington St., Brooklyn, NY 11231  
Telephone: (718) 875-6700 • Fax: (718) 858-0029  
Website: www.bamarine.com E-mail: service@bamarine.com  
QUALITY... SERVICE... VALUE

• OFFSHORE & INLAND  
• SALVAGE & WRECK  
REMOVAL  
• PLATFORM REMOVAL  
• PLATFORM INSTALLA-  
TION  
• HEAVY LIFT

P.O. BOX 4113  
NEW ORLEANS, LOUISIANA  
70178

Phone: (504) 866-6341  
Fax: (504) 865-8132

Bludworth Cook Marine  
ATB Flexible Connection Systems  
Richard Bludworth & John Cook  
Houston, Texas  
(713) 644-1595  
(281) 996-1414  
rbludworth@hotmail.com  
jcookmarine@aol.com  
www.vesselrepair.com  
(link)



### BMT DESIGNERS & PLANNERS

NAVAL ARCHITECTURE  
MARINE ENGINEERING  
ENVIRONMENT & SAFETY  
OFFSHORE ENGINEERING SERVICES

2120 Washington Blvd, Suite 200  
Arlington, VA 22204-5717  
Phone: (703) 920-7070  
Fax: (703) 920-7177  
Email: dandp@dandp.com  
Website: www.dandp.com

### sms BMT SCIENTIFIC MARINE SERVICES

MARINE INSTRUMENTATION  
HULL MONITORING  
TRIALS & TESTING  
OCEAN ENGINEERING

9835B Whithorn Drive Houston, Texas 77095  
Phone: (281) 858-8090  
Fax: (281) 858-8898  
101 State Place, Suite N Escondido, CA 92029  
Phone: (760) 737-3505  
Fax: (760) 737-0232  
Email: sms@scimar.com - Website: www.scimar.com

### FTL FLEET TECHNOLOGY

NAVAL ARCHITECTURE  
TESTING & TRIALS  
STRUCTURAL INTEGRITY ASSESSMENT  
ICEBREAKERS & ARCTIC ENGINEERING

311 Legget Drive, Kanata Ontario  
Canada K2K 1Z8  
Phone: (613) 592-2830 Fax: (613) 592-4950  
Email: fleet@fleetech.com  
Website: www.fleetech.com

### BRISTOL HARBOR MARINE DESIGN

a division of Bristol Harbor Group, Inc.

Naval Architects  
Marine Engineers

103 Poppasquash Road  
Bristol, RI 02809  
phone: 401-253-4318  
fax: 401-253-2329  
www.bristolharbortgroup.com  
design@bristolharbortgroup.com

### C.R. CUSHING & CO., INC.

NAVAL ARCHITECTS, MARINE ENGINEERS  
& TRANSPORTATION CONSULTANTS  
18 Vesey Street  
NEW YORK, NY 10007

TEL: (212) 964-1180  
FAX: (212) 285-1334  
CRCUSHING@AOL.COM

### CDI

CDI Government Services

CDI Marine Company 904-805-0700  
The M&T Company 732-657-5600

Band, Lavis & Associates  
410-544-2800  
301-261-1030

Naval Architecture Marine Design  
Military Aviation Support

JACKSONVILLE, FL - BREMERTON, WA  
ISLANDIA, NY - PHILADELPHIA, PA  
LAKEHURST, NJ - PATUXENT RIVER, MD  
PASCAGOULA, MS - PORTSMOUTH, VA  
SEVERNA PARK, MD - SAN DIEGO, CA

Visit us at our web site at  
http://www.cdi-gs.com

Email  
cdi-gs@cdicorp.com

501 WORK

CHILDS ENGINEERING CORPORATION  
WATERFRONT ENGINEERING • DIVING INSPECTION  
BOX 333 MEDFIELD, MA 02052 (508) 359-8945

SOUTH FLORIDA'S PREMIER YACHT  
SERVICE FACILITY IS SEEKING SKILLED,  
MOTIVATED, PROFESSIONALS TO FILL  
POSITIONS AS Marine Carpenters/  
Joiners, Marine Diesel Generator  
Mechanics, Systems Mechanics,  
& Marine Painters.  
COMPETITIVE SALARIES AND EXCELLENT  
BENEFITS PLUS A GREAT LOCATION!

### RYBOVICH SPENCER

4200 No. Flagler Drive, W. Palm Beach, FL 33407  
(561) 840-8113 Fax: (561) 844-8393  
www.rybovich.com e-mail: beths@rybovich.com



Administration - Construction  
Crewing - Engineering  
Finance - M & R  
Operations - Sales

(Established 1969) P O Box 260 • Mercer Island, WA 98040 • 206-232-6041

Time, Experience, & Reliability...

## THE MARITIME GROUP

Since 1939 The Maritime Group has been a leader in the marine industry. Today it's supported by a network of publications and electronic products.

MARITIME  
REPORTER  
AND  
ENGINEERING NEWS

MarineNews

MarineLink.com MaritimeEquipment.com  
MaritimeJobs.com MaritimeToday.com

The Maritime Group has a combined  
audience of over 450,000 each month.  
In a unsure market make sure you get the most  
out of your advertising dollar.

Reserve your ad today!  
Call: 212-477-6700

# THE MARINE MART

The Classified  
and Employment Section



## Professional

Serving the marine industry for over 140 years



### CRANDALL DRY DOCK ENGINEERS, INC.

- Consulting • Design • Inspection
- Railway and Floating Dry Docks
- Dry Dock Hardware and Equipment

Box 505804, Chelsea, MA 02150 (617) 884-8420 Fax: (617) 884-8466  
www.crandalldrydock.com



### GHS General HydroStatics

Ship Stability and Strength Software

*Creative Systems, Inc.*

Creators of GHS™

P.O. Box 1910 Port Townsend, WA 98368 USA  
phone: (360) 385-6212 fax: 385-6213  
email: sales@ghsport.com  
www.ghsport.com/ghs

### Donjon Marine Co., Inc.

Marine Construction

Salvage

Dredging

Diving

Heavy-Lift

Towing

Cable-Lay Support

www.donjon.com inquiries@donjon.com  
1250 Liberty Avenue, Hillside, New Jersey 07205  
Phone: (908) 964-8812 Fax: (908) 964-7426

### JOHN W. GILBERT ASSOCIATES, INC.

Naval Architects  Marine Engineers

(781) 740-8193  
FAX (781) 740-8197

75 Terry Drive, Suite 200  
Hingham, MA 02043



### GLOSTEN

The Glosten Associates, Incorporated

Naval Architecture Marine Engineering Ocean Engineering Hydrodynamics Transportation Analysis Contract Administration

605 First Avenue, No. 600 Seattle, WA 98104-2224 Phone: (206) 624-7850 Fax: (206) 682-9117

CONSULTING ENGINEERS SERVING THE MARINE COMMUNITY

### HEGER DRY DOCK, INC.

13 Water Street, Holliston, MA 01746

Engineering for all types of dry docks

- Design • Docking Calculations
- Certifications • Engineer/Diver
- Inspections • U.S. Navy 1625C FCR's
- Dockmaster Training Classes

Phone: (508) 429-1800 Fax: (508) 429-1811  
www.hegerdrydock.com

**CUNNINGHAM & WALKER**  
MARINE CONSULTANTS, INC.

NAVAL ARCHITECTURE & MARINE ENGINEERING  
MARINE HVAC ENGINEERING  
MARINE ELECTRICAL ENGINEERING

1762 PROVIDENCE HOLLOW LANE, JACKSONVILLE, FL 32223  
TEL 904 292 9293 FAX 904 824 1423



### EVERETT ENGINEERING, INC.

"INGENUITY UNLIMITED"

BEST EQUIPPED SHOP IN THE AREA

1420 W. MARINE VIEW DRIVE • EVERETT, WA. 98201  
FAX (425) 258-1288 • (425) 259-3117

**HERBERT ENGINEERING CORP.**  
2417 Mariner Square Loop, Suite 125  
Alameda, CA 94501

Naval Architects • Marine Engineers • Marine Software Specialists

Tel: (510) 814-9700 E-mail: info@herbert.com  
Fax: (510) 814-9763 http://www.herbert.com

### CUNNINGHAM MARINE HYDRAULICS CO., INC.

Service Parts Repair Consulting

Litton Marine Systems  
Authorized Sperry - Decca - C. Plath Dealer

### CMH HELE-SHAW, INC.



201 Harrison Street  
Hoboken, N.J. 07030  
(201) 792-0500 # (212) 267-0328  
1-800-322-2641  
FAX# (201) 792-7716

E-Mail Address:  
cmh-hydraulics@erols.com



OFFICE: (425) 787-5832  
FAX: (425) 787-2522  
CELLULAR: (206) 786-2354

### FAB - IT - RITE, INC.

VESSEL DOCKSIDE REPAIRS & CONVERSIONS  
SEAFOOD PROCESS PLANT UPGRADES

..... FULL MACHINE & FABRICATION SHOPS.....  
..... MOBILE CREW WITH TOOLS.....

15332 Hwy 99 #4, Lynnwood, WA 98037  
E-MAIL: RDITMER@EXCITE.COM

### Fleetway Inc.

- Marine Engineering • Naval Architecture
- Life Cycle Support

Suite 200, 155 Chain Lake Drive, Halifax, Nova Scotia, Canada B3S 1B3  
Phone: (902) 494-5700 Fax: (902) 494-5792

Detail Design & Drafting  
3D Modeling, Lofting, Nesting

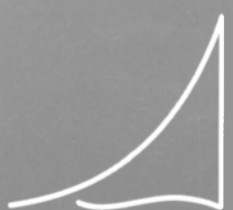

Genoa Design International Ltd.

Tel: 709-834-7428  
www.genoadesign.com

### John J. McMullen Associates, Inc.

An Employee Owned Company



Naval Architects  
Marine Engineers  
Program Support Specialists

Alexandria, VA • Washington, DC • New York, NY  
Newport News, VA • Pascagoula, MS • Pittsburgh, PA  
Philadelphia, PA • Bath, ME • Port Hueneme, CA  
Bremerton, WA • N. Charleston, SC

Corporate Headquarters:

4300 King Street Suite 400 Alexandria, VA 22302  
Business Development: (703) 933-6690 Fax: (703) 933-6777  
Web Site: www.JJMA.com Email: Marketing@JJMA.com

CERTIFIED  
ISO 9002



JMS NAVAL ARCHITECTS  
SALVAGE ENGINEERS  
The sea-going naval architects.  
860-448-4850 • jmsnet.com

# THE MARINE MART

The Classified  
and Employment Section



## Professional

### KGW

SCHWERINER  
MASCHINENBAU GMBH

**SMM 2002**  
Hall 10 EG  
Stand 10021

- Deck machinery (steering gears, rudder systems, winches, deck cranes)
- Steel-tube towers for wind power plants
- Wind-powered air conditioning systems
- Sea-water recycling systems

Engineering moves our world

Wismarsche Str. 380, D-19055 Schwerin, Phone: +49 (0385) 5731 0, Fax: +49 (0385) 5731 322, Email: info@kgw-schwerin.de

### MSC MARINE SYSTEMS CORPORATION

MARINE ENGINEERS / NAVAL ARCHITECTS

HM&E Design    Drawings    Logistic Support  
Inspection    Vibration    Testing Programs

68 FARGO STREET, BOSTON, MA 02210  
TEL (617) 542-3345 FAX (617) 542-2461

INFO @ MSCORP.NET  
WWW.MSCORP.NET

### Schrider

Naval Architects

& Associates, Inc.  
Marine Engineers

P.O. Box 2546  
Daphne, AL 36526  
E-mail: info@schrider.com

Office: (251) 621-1813  
Fax: (251) 626-1814

Technical and Managerial Solutions for Shipyards & Vessel Owners

### The Lightship Group, LLC



#### MARINE SUPPORT SERVICES

SHIPBOARD VIBRATION • INFRARED •  
VOYAGE REPAIRS • INVENTORIES

PHONE: 401 294-3341

FAX: 401 294-3415

SHIPS@LIGHTSHIPGROUP.COM

WWW.LIGHTSHIPGROUP.COM

OUONSET POINT, RHODE ISLAND  
NORFOLK, VIRGINIA

### MOSS MARINE USA, Inc.

Naval Architects, Marine Engineers, Surveying & Repair

410-542-8775    fax 410-542-8115

Baltimore, MD 21209

www.mossmarineusa.com

### Seaworthy Systems, Inc.

ISO 9001

MARINE ENGINEERS AND NAVAL ARCHITECTS

Essex, CT 06426

(860) 767-9061; Fax: (860) 767-1263; www.seaworthysys.com  
SAN FRANCISCO • PHILADELPHIA • WASHINGTON, DC

### CRUISE SHIP SPECIALISTS



#### Nautical Designs Inc.

NAVAL ARCHITECTS / MARINE ENGINEERS

2101 S. ANDREWS AVE. FT. LAUDERDALE, FL 33316 PH. (954) 463-2033

### GEORGE G. SHARP, INC.

100 CHURCH STREET, NEW YORK, NY 10007  
TEL (212) 732-2800    FAX (212) 732-2809

WASHINGTON (703) 548-4400  
VIRGINIA BEACH (757) 499-4125  
SAN DIEGO (619) 425-4211

MARINE SYSTEMS • ANALYSIS & DESIGN

### M.A.C.E.

FT. LAUDERDALE - USA - WORLDWIDE  
PHONE: (954) 493-8913 • FAX: (954) 493-9559

- N.D.T. Services
- Vibration - noise - structural/modal analysis
- Field balancing. Laser Alignment
- Torque - torsional vibration analysis
- IR - Thermography inspection
- Emission tests. Engine Performance tests

Reliable Results  
In Marine Performance Evaluation  
Numerical Modeling • Model Testing • Design Evaluation

**OCEANIC**  
CONSULTING CORPORATION  
Marine Performance Evaluation

St John's, Newfoundland, Canada  
Houston, Texas, USA

www.oceaniccorp.com



### A. K. Suda, Inc.

NAVAL ARCHITECTS & MARINE ENGINEERS

- Concept & Contract Design
- Construction Drawings
- Transportation Analysis
- Owner Representation

3004 19th Street • Metairie, LA 70002  
Ph. (504) 835-1500 • Fax (504) 831-1925 • info@aksuda.com

### MCA ENGINEERS, INC.

- \* Marine Structural Engineering (FEA, Fatigue,...)
- \* Hull Monitoring System (Motions, Stress,...)
- \* Ship Repair Analyses & New Designs
- \* Mooring Master (Analyses / Monitoring)
- \* Vessel Information Archive System (Multimedia)
- \* FracTrac Relational DataBase
- \* Ultrasonic Leak Detection

e-mail: info@mcaengineers.com

web-site: www.mcaengineers.com

Phone: (714) 662-0500 Fax: (714) 668-0300  
2960 Airway Ave., A-103, Costa Mesa, CA 92626

### M. ROSENBLATT & SON

an AMSEC LLC Group

NAVAL ARCHITECTS • MARINE ENGINEERS

Advisors and Consultants on Marine Matters of All Types

San Francisco • Bremerton • New York • San Diego • Washington, DC  
New Orleans • Newport News • Virginia Beach • Charleston • Philadelphia

For information please contact Marketing at (703) 415-7800

E-Mail: info@mrosenblatt.amsec.com

Web Site: www.mrosenblatt.com

### SURVIVAL SYSTEMS INTERNATIONAL



LIFEBOAT INSPECTION, REPAIRS, PARTS.

PHONE: (504) 469-4545, FAX: (504) 466-1884.  
E-mail: llifeboatserv@earthlink.net

### UNIVERSE

Maritime Business and Engineering Solutions

For companies striving to

- Increase profits
- eliminate non-value-added work
- reduce project risk
- leverage core competencies

Universe Ships, Inc.  
CUSTOMIZED SOLUTIONS  
DESIGNED TO FIT YOUR NEEDS  
**(713) 417-7131**

UNIVERSE offers superior

- Naval Architecture
- Project Management
- Stability Analysis
- Asset Management
- Collaboration
- Solutions
- Critical Skill Leasing
- Process Re-Engineering & Life Cycle Engineering Services

Offices in: Houston, Texas  
Glasgow, Scotland  
& Singapore

### Coast Guard/State Pilotage License Insurance

Worried about defending your license or yourself in a hearing conducted by the Coast Guard, National Transportation Safety Board or a State Pilotage Authority, which could result in license revocation, suspension or assessment of a fine/money damages against you personally?

Stop worrying. Insure yourself and your license with a Marine License Insurance Policy. For more information, contact R.J. Mellusi & Co., 71 Hudson Street, New York, N.Y. 10013, Tel. (212) 962-1590 Fax (212) 385-0920, E-mail: rmellusi@rdt.net.com

### SARGENT & HERKES, INC.

NAVAL ARCHITECTS • MARINE ENGINEERS

225 BARONNE ST., SUITE 1405

NEW ORLEANS, LA 70112

504-524-1612 • 504-523-2576 (Fax)

E-mail: sahinc@bellsouth.net

www.acmo-inc.com



Alan C. McCLURE ASSOCIATES, INC.  
Naval Architects • Engineers

2600 South Gessner • Suite 504 • Houston, Texas 77063  
Tel: (713) 789-1840 • Fax: (713) 789-1347 • E-mail: info@acmo-inc.com

# A propulsion system bearing that gives you competitive advantage...

COMPLETELY SPLIT TO THE SHAFT ROLLER BEARINGS

**The Cooper Bearings Group is a full service supplier with over 100 years of product knowledge and marine propulsion expertise.**

The Cooper split to the shaft roller bearing solves difficult alignment problems, minimises downtime and reduces maintenance hours giving you and your customers a competitive edge.

In addition, when replacement is necessary, Cooper users save valuable time that would otherwise be lost by the time consuming replacement of non-split bearings.

As a global company, we place great emphasis on professional local representation and have an established network of authorized partners and local sales managers to assist you.

A call to our local sales office will be your first step to having the advantage.

Call Cooper now...

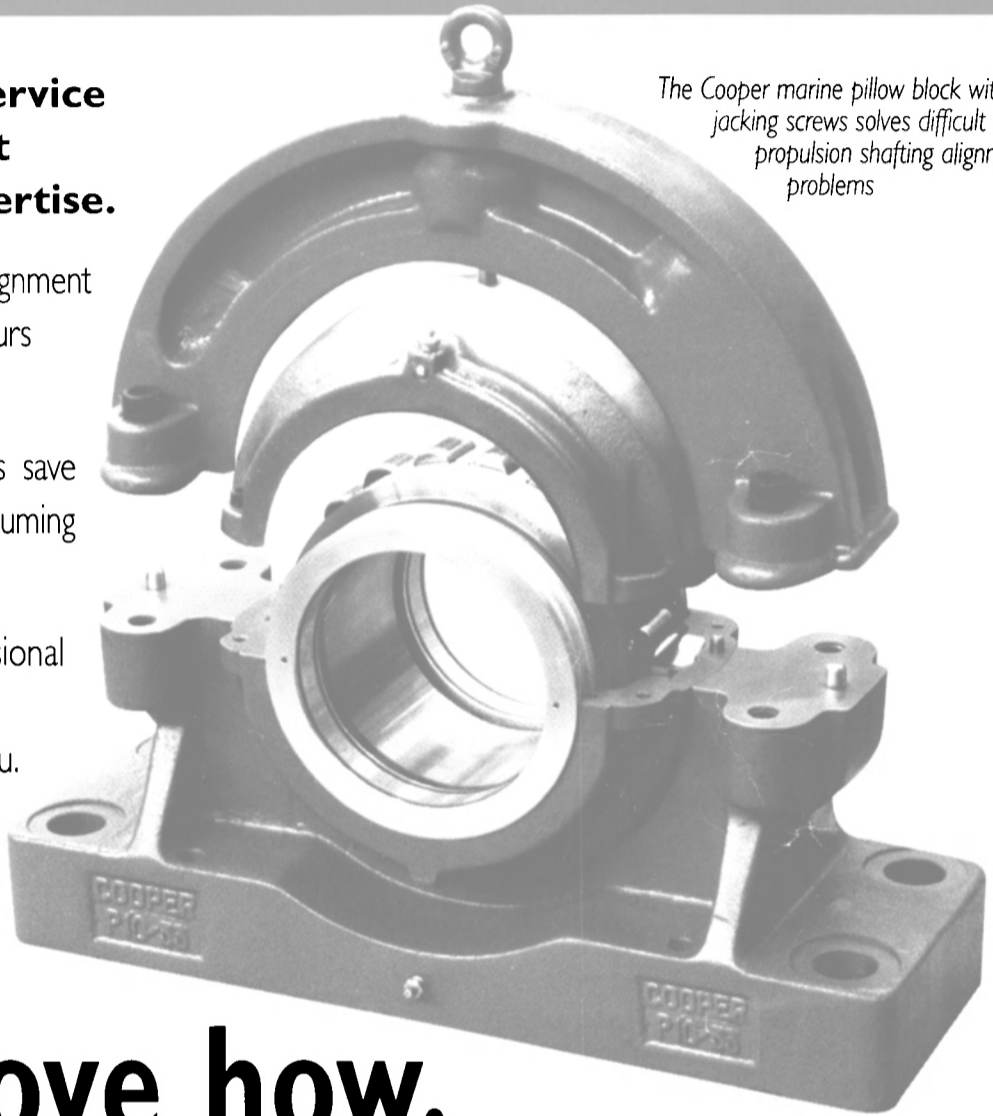

*The Cooper marine pillow block with jacking screws solves difficult propulsion shafting alignment problems*

## ...and we'll prove how.

Typical shipboard applications:

- Propulsion shafting**
- Bow thrusters**
- Deck machinery**
- Rudder stocks**
- Shipboard conveyors**
- Fans for inert gas**

Easy access for maintenance and inspection on propulsion shafting gives more uptime and lower maintenance, inspection and replacement costs



**Cooper Bearings Group**  
Wisbech Road, King's Lynn,  
Norfolk, PE30 5JX, England.

Telephone +44 (0) 1553 763 447.  
Fax +44 (0) 1553 761 113

Web site: [cooperbearings.com](http://cooperbearings.com)

Offices and representation worldwide

Visit us at Shipbuilding, Machinery and Marine Technology Fair, Hamburg, Germany.  
September 24 - 28 2002. Hall 03 EG, Stand 3004

# COOPER

A Supplier of Competitive Advantage

Accepted by American Bureau of Shipping, Det Norske Veritas, Germanischer Lloyd, RINA and Lloyds

Circle 219 on Reader Service Card or visit [www.maritimereporterinfo.com](http://www.maritimereporterinfo.com)

**KARL SENNER, INC** ... *When Only The Best Will Do*



## M/V JAY BLUDWORTH

**KARL SENNER, INC**, supplied two (2) REINTJES WAF 842  
Vertical Offset, Reverse Reduction Marine Gears, Reduction Ratio 3.905:1.

**OWNER:** Republic Barge Transportation Company  
Hockley, Texas

**SHIPYARD:** John Bludworth, L.L.C.  
Corpus Christi, Texas

**REINTJES**  
MARINE GEARBOXES

**BERG PROPULSION**  
CONTROLLABLE PITCH PROPELLERS  
AND BOWTHRUSTERS



**REXROTH**  
MARINE CONTROLS

**SALES, PARTS, SERVICE • 500 H.P. TO 20,000 H.P.**



# Karl Senner, Inc.

**WEST COAST**  
Karl Senner, Inc.  
12302 42nd Drive S.E.  
Everett, WA 98208  
Mr. Whitney Ducker.  
(425) 338-3344

**NEW ORLEANS**  
Karl Senner, Inc.  
25 W. Third St.  
Kenner, LA 70062  
(504) 469-4000  
Telefax: (504) 464-7528

**EAST COAST**  
Olof Wadehn Enterprises  
30 Sheppard Lane  
Huntington, Long Island  
New York 11743  
Mr. Olof Wadehn  
(631) 692-4548

Visit our website at <http://www.karlsenner.com>  
E-mail address: [service@karlsenner.com](mailto:service@karlsenner.com) • [sales@karlsenner.com](mailto:sales@karlsenner.com) • [parts@karlsenner.com](mailto:parts@karlsenner.com)

Circle 251 on Reader Service Card or visit [www.maritimereporterinfo.com](http://www.maritimereporterinfo.com)