

Marine

News

JULY 2022

www.marinelink.com

Propulsion Technology

Green in the Spotlight



Kvitbjørn

Innovation in the Arctic

Batteries

Ready to Scale Up

Hydrogen as Fuel

Possibilities, But...

Jörg Franzke

One-on-one with Scania's
New US President



Keeping You Moving Is All We Do.

For more than 100 years, operators have trusted ZF with keeping them in motion on the water. Offering industry-leading propulsion solutions – including transmissions, propellers, thrusters, controls, electronics and more – ZF has the expertise and high-performing products that deliver on our dedication to the go.

Talk to a Go Expert: **1.833.ZFWRENCH**

www.zfmarinepropulsion.com/go





IGP

INTELATUS

GLOBAL PARTNERS

OFFSHORE WIND MARKET INTELLIGENCE PACKAGE

2022 U.S. Offshore Wind Outlook and Market Forecast

The monthly report and database contains all of the latest developments and information on the projects that will lead the U.S. to deploy 30 GW of offshore wind by 2030 and 110 GW by 2050. The report contains insights to support component manufacturers, shipyards, vessel owners and operators, service providers, ports and terminal operators, public agencies and financial institutions amongst others to better understand the opportunities and challenges presented by this growing segment.

Get all the information you need to access this growing multi-billion dollar market today!

VISIT US

WWW.INTELATUS.COM

Contents

Features

22 Kvitbjørn

Marine News goes on board a new hybrid-electric excursion boat showcasing the some of the latest developments from Volvo Penta, including its “e-mobility-as-a-service” business model.

By Eric Haun



26 Batteries: Ready to Scale Up

Recent developments confirm that maritime battery applications are moving out of the experimental stage, and that vessel electrification is available and in demand.

By Tom Ewing



32 Hydrogen as Fuel: Possibilities, But...

Hydrogen is in the spotlight as a fuel that could potentially replace fossil fuels on the maritime decarbonization journey. But there are challenges.

By Tom Ewing



4 Editor's Note

6 Authors

10 Insights:

Jörg Franzke, President,
Scania U.S.A., Inc.

16 OpEd: CARB Emissions Regulations

By Martin Curtin

18 Column: Autonomous Vessels

By Alan Weigel

38 Profile: Ahead Sanitation Systems, Inc.

40 Vessels

42 People & Company News

43 Products

44 Editorial Calendar

45 Classified Advertising

48 Advertisers Index

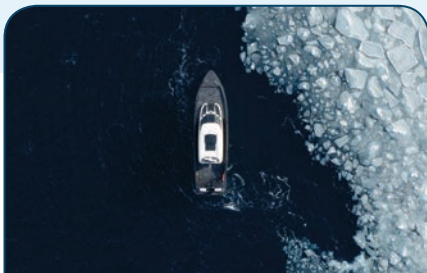

On the Cover

Kvitbjørn is a new 14.9-meter excursion vessel in Svalbard that runs on a hybrid-electric propulsion system developed by Volvo Penta in partnership with builder Marell Boats and operator Hurtigruten Svalbard.

(Photo: Volvo Penta)



Challenge Everything

We've spent more than a century investing in solutions that deliver more power, reliability, and fuel savings. Leveraging the R&D resources and proven experiences of the Volvo Group to bring our customers to the forefront of sustainable driveline technologies.

We don't just do things for the sake of doing them, and we know you don't either. Together, let's rethink the possibilities and take your operations – and bottom line – to the next level.

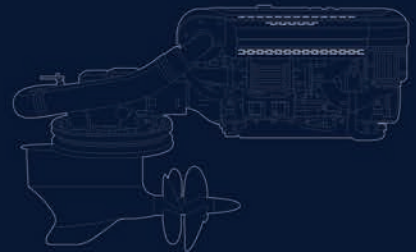

Lower Total Cost of Ownership
Better Value in The Long Run



Fuel Efficiency
Reduce Your Operational Cost



Service and Support
Global Dealer Network with Local Expertise



Visit volvopenta.us/challenge to learn more about why Volvo Penta is the best engine supplier partner for your business.

V O L V O P E N T A

Contact your nearest Volvo Penta Power Center to discuss your power needs

Atlantic Detroit Diesel-Allison
732-309-3410
Servicing: CT | NJ | NY | VT

Helmut's Marine
(415) 453-1001
AZ | CA | HI | NV | UT | Guam

Pacific Power Group
(253) 854-0505
AK | ID | OR | WA

Stewart & Stevenson
(713) 751-2700
TX

Cullen Diesel Power
(804) 888-1211 — Canada
AB | BC | MB | NT | SK | YT

Interstate Power Systems
(262) 783-8701
IA | IL | IN | MI | MN | WI

Power Products
(781) 246-1811
MA | ME | NH | RI

Wajax Power Systems
(418) 651-5371 — Canada
NL | NB | NS | PE | QC |
St. Pierre et Miquelon

Florida Detroit Diesel-Allison
(954) 327-4440
AL | FL | LA | MS | Bahamas

Johnson & Towers
(609) 272-1415 — DE | MD
NJ | Eastern PA | Bermuda

Star Marine
(800) 999-0356
Mexico

Western Branch Diesel
(757) 673-7000 — GA | Eastern KY | NC
OH | VA | WV | Western PA | SC | Eastern TN

Editor's Note



Eric Haun, Editor,
haun@marinelink.com

Earlier this year, *Marine News* was one of a handful of publications invited on a very unique boat tour, just a few hundred miles away from the North Pole. While Svalbard is quite a bit outside of the scope of this publication's typical North American coverage, the vessel we saw there—as well as its potentially groundbreaking business model and hybrid-electric propulsion system—should certainly be of interest to readers everywhere.

Kvitbjørn is a first-of-its-kind excursion vessel that runs on a hybrid-electric propulsion system developed by Volvo Penta in partnership with Marell Boats and Hurtigruten Svalbard. The tech on board is certainly interesting, especially in the harsh Arctic conditions in which the vessel has been built to operate. But perhaps even more intriguing is Volvo Penta's new "e-mobility-as-a-service" business model, which will see Hurtigruten Svalbard pay by the kilowatt-hour for the vessel's operation. Read the full story starting on page 22.

Volvo Penta, which sees electrification taking off in both the commercial and leisure marine markets, is trialing the concept to help owners and operators avoid the higher upfront costs for green hybrid and full electric propulsion solutions. Will the model work? Only time will tell.

Marine News (ISSN# 1087-3864) is published monthly except for February, August and December by Maritime Activity Reports Inc. 118 E 25th St. New York, NY 10010-1062. Periodicals Postage Paid at New York, NY and additional mailing offices. POSTMASTER: Send all UAA to CFS. NON-POSTAL AND MILITARY FACILITIES send address corrections to Marine News 850 Montauk Hwy, #867 Bayport, NY 11705.

The publisher assumes no responsibility for any misprints or claims or actions taken by advertisers. The publisher reserves the right to refuse any advertising. Contents of the publication either in whole or part may not be produced without the express permission of the publisher.

Marine News

(ISSN#1087-3864) (USPS#013-952)

New York: 118 E. 25th St., New York, NY 10010
tel: (212) 477-6700; fax: (212) 254-6271
www.marinelink.com

CEO

John C. O'Malley • jomalley@marinelink.com

Publisher & Editorial Director

Greg Trauthwein • trauthwein@marinelink.com

Editor

Eric Haun • haun@marinelink.com
Tel: 212-477-6700

Contributing Writers

Tom Ewing, Don Gale, Jim Kearns, Barry Parker, Jeff Vogel

PRODUCTION

Production & Graphics Manager

Nicole Ventimiglia • nicole@marinelink.com

SALES

Vice President, Sales & Marketing

Terry Breese • breeset@marinelink.com
Tel: 561-732-1185 Fax: 561-732-8414

Advertising Sales Managers

Lucia Annunziata • annunziata@marinelink.com
Tel: 212-477-6700 ext 6240 Fax: 212-254-6271

John Cagni

Tel: 631-472-2715

• cagni@marinelink.com

Frank Covella

Tel: 561-732-1659

• covella@marinelink.com
Fax: 561-732-8063

Mike Kozlowski

Tel: 561-733-2477

• kozlowski@marinelink.com
Fax: 561-732-9670

Gary Lewis

Tel: 516-441-7258

• lewis@offshore-engineer.com

Managing Director, Intl. Sales

Paul Barrett • ieaco@aol.com
Tel: +44 1268 711560 Fax: +44 1268 711567

CORPORATE STAFF

Manager, Marketing

Mark O'Malley • momalley@marinelink.com

Accounting

Esther Rothenberger • rothenberger@marinelink.com
Tel: 212-477-6700 ext 6810

Manager, Info Tech Services

Vladimir Bibik

CIRCULATION

Kathleen Hickey • k.hickey@marinelink.com
Tel: 212-477-6700 ext 6320

TO SUBSCRIBE:

Subscriptions to *Marine News* (9 printed issues) for one year are available for \$50.00; Two years (18 printed issues) for \$80.00. Send your check payable to:
Marine News, 118 E. 25th St., New York, NY 10010

Member



Business Publications Audit
of Circulation, Inc.



CELEBRATING SAFETY

Working on the waterfront requires a commitment to safety. As a leading USL&H provider, we take that commitment seriously. That's why each year we celebrate our members with the strongest safety cultures in the business. Congratulations to our 2021 Safety Award winners.

Alabama Steel Terminals, LLC
American Commercial Barge Line
APM Terminals Mobile
Austal USA, LLC
Ballard Marine Construction
Beacon West Energy Group
Conrad Shipyard
First Marine, LLC
Fluid Crane & Construction, Inc.
Jay Cashman, Inc.
JB Marine Service, Inc.
Jesse Co.
Keppel AmFELS, Inc.
Lake Union Drydock Co.
Logan Diving & Salvage

Marine Group Boat Works, LLC
Marquis Marine, Inc.
Mike Hooks, LLC
Mistras Group, Inc.
MK Industries, Inc.
Offshore Inland Marine & Oilfield
Patti Marine Enterprises
Peoples Industries, Inc.
Salmon Bay Barge Line
Superior Shipyard & Fabrication, Inc.
Team Services, LLC
the COOPER GROUP of companies
Union Maintenance Corporation
Watco Transloading, LLC

Contributors



- 1 Captain Martin Curtin,** tugboat operator by trade, is the founder and CEO of Curtin Maritime based in Long Beach, Calif.
- 2 Tom Ewing** is a freelance writer specializing in energy and environmental issues. He contributes regularly to this magazine.
- 3 Don Gale** is a freelance writer with over three decades of engineering and naval architecture experience. His background covers naval, commercial and recreational craft.

- 4 Barry Parker** of bdp1 Consulting Ltd provides strategic and tactical support, including analytics and communications, to businesses across the maritime spectrum. He is a freelance writer and regular contributor to this magazine.
- 5 Alan Weigel,** of counsel, Blank Rome, focuses his practice on all aspects of commercial and insurance litigation and arbitration, with particular emphasis on the maritime industry.

TAKE THE **WORK** OUT OF **WORKBOAT**

Keep your boat in the water with Thordon's **TG100 Shaft Seal**

- Emergency seal offers safe return to port capability
- No expensive maintenance overhaul
- No wear on the shaft or liner
- No spare parts required
- Large stock availability at our two strategically located US Warehouses for fast delivery



TG100
Shaft Seal

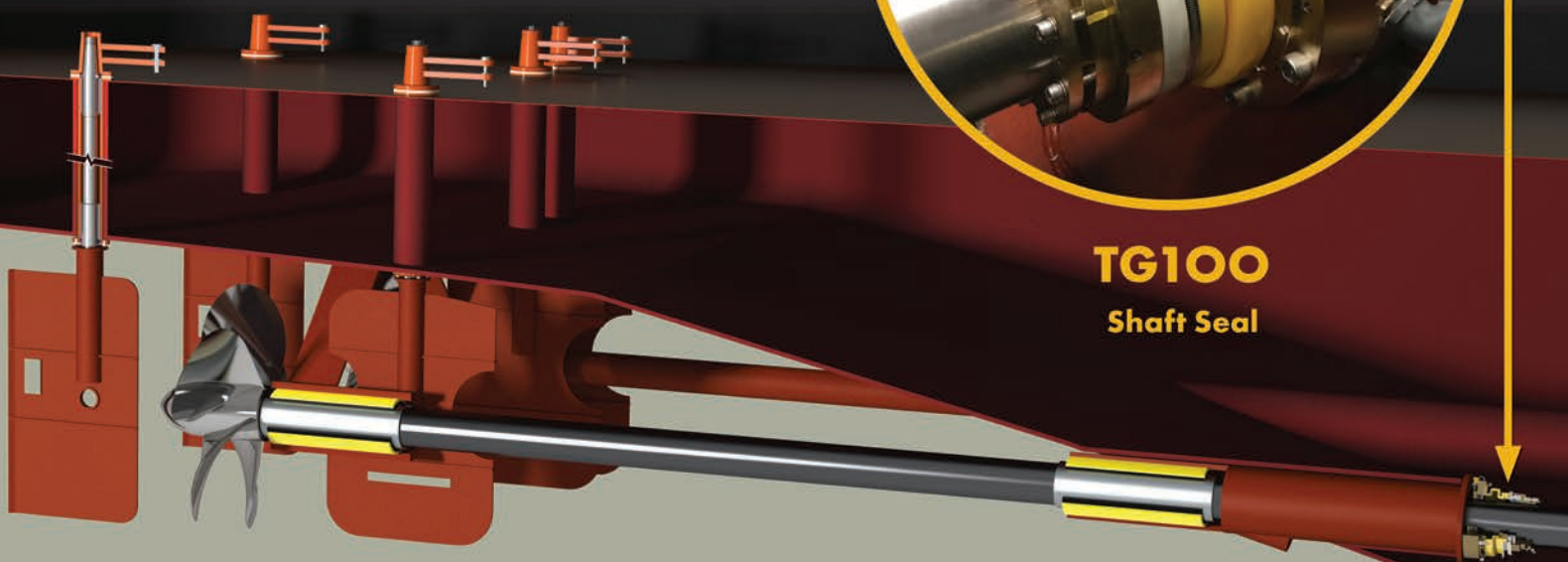

Give Thordon's reliable and knowledgeable US Inland Waterways team members a call today!

"We work hard so that you don't have to."



MISSISSIPPI AND OHIO RIVERS

Kasey Cummings

270-493-0482

kaseyc@thordonbearings.com



Jason Perry

502-612-9051

jasonp@thordonbearings.com



GULF COAST

Jim Bright

228-235-6495

jimb@thordonbearings.com

ZERO POLLUTION | HIGH PERFORMANCE | BEARING & SEAL SYSTEMS

THORDON

www.ThordonBearings.com

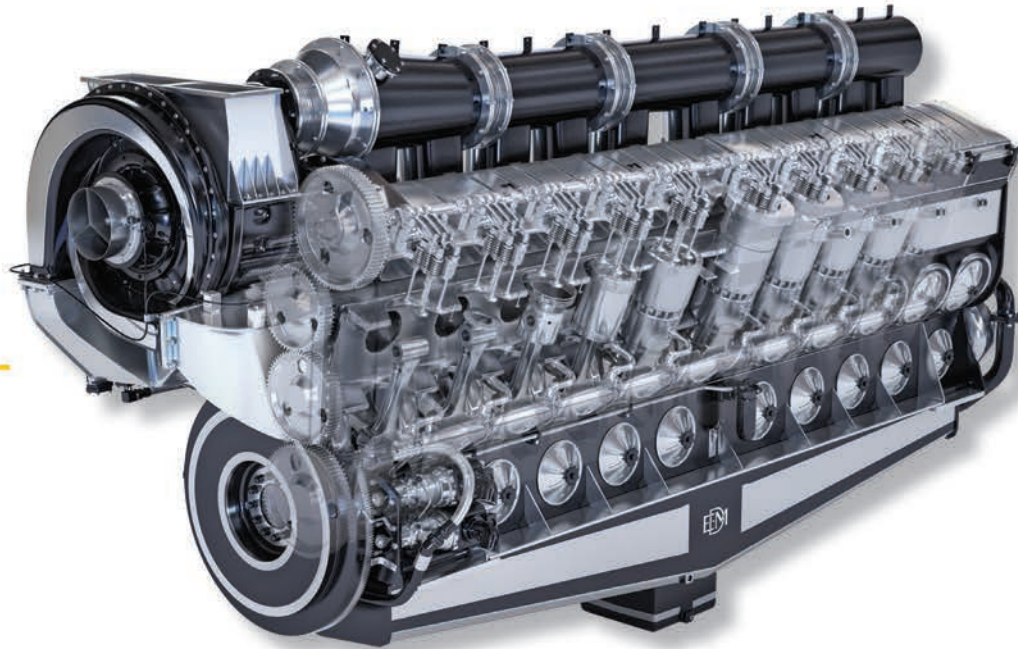

The E 23 (IMO II-EPA T3) and E 23B (IMO III-EPA T4F) are available in 8, 12, 16 and 20 cylinder configurations with power ratings from (1675 hp) to (5500 hp).

*"Please consult MSI for specific application ratings"

TWO CYCLE ADVANTAGE

ENDURING DESIGN.
LEGENDARY HERITAGE.



BEST IN-CLASS TRANSIENT RESPONSE

- E 23 offers the performance of a high speed engine with the durability advantage of a medium speed engine.
- Ample power margin throughout the entire operating speed range allows for optimized engine sizing and a single speed reduction gear.
- Avoids engine lugging under demanding vessel maneuvers.
- Accepts 100% block load in constant speed applications.

TOTAL COST OF OWNERSHIP ADVANTAGE

MAXIMUM UPTIME.

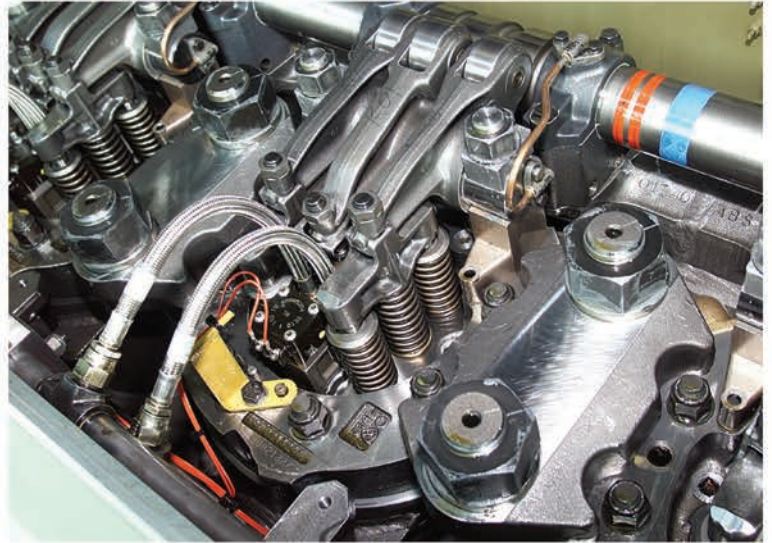

PARTS – LABOR – FLUIDS

Downtime is expensive. EMD engines are designed to minimize the amount of time needed for maintenance and repairs in order to maximize your productivity, keeping operational costs to a minimum.

- Reduced fuel consumption over previous models due to EPA T4F / IMO III technologies and low idle speed.
- Easy non-invasive inspection of cylinder components for simple predictive condition-based maintenance.
- Simple overhauls to minimize downtime – Power Assembly (head, liner, piston, rod) can be removed and replaced as one unit.
- Closed loop dosing control system optimizes (Diesel Exhaust Fluid) DEF usage.
- No oil change required between overhauls unless indicated by oil sample analysis.
- Lowest life cycle cost per horse power / hours of operation.

Ph: (985) 223-7100 • www.marinesystemsinc.com



Jörg Franzke

President,
Scania U.S.A., Inc.

Jörg Franzke, the newly appointed president of Scania U.S.A., Inc., is a company veteran, having been with the Scania group since 1995, building a wide experience in various positions such as Services, Truck Sales, R&D, Network Development and Quality Management. And prior to his current role, Franzke was the Head of Power Solutions at Scania Germany for 10 years. He weighs in on how Scania is helping customers meet their decarbonization agendas, and lays out challenges and opportunities on the path ahead.



All images: Scania

The commercial marine industry is seeing major changes in several key areas, especially in digitalization and decarbonization. How do you see these shifts, and how does Scania USA fit into the picture?

JF: The growing shift towards being sustainable strongly aligns with Scania's core values—to drive the shift towards a sustainable transport system, creating a world of mobility that is better for business, society and the environment.

Scania's long-standing compatibility with alternative fuels like hydrotreated vegetable oil (HVO) and biodiesel continue to meet end users' needs for equipment that can be cleaner. We give OEMs and builders the ability to meet a new requirement by simply selecting Scania engines.

Furthermore, the launch of our electrified power systems will give customers a hybrid and fully electric solution. With a potential CO2 emission reduction of up to

92%, Scania's hybrid electric system combines an e-machine with a combustion engine—either together or as standalone power sources. The fully electric system enables a potential CO2 emission reduction of up to 98% if the electricity is generated from renewable sources.

What sets Scania's new e-Machine apart from other solutions on the market, and what types of vessels is it best suited for?

JF: Our in-house developed electric solutions draw on Scania's extensive experience, knowledge and technology from electrifying on-road vehicles, resulting in high system reliability and outstanding performance in a compact design. All components work seamlessly together and are controlled by a common management system. The single system management interface and the single mechanical interface—CAN J1939 and SAE 1—will re-

Insights

main as previous and thereby simplify integration with external components.

The e-Machine will be both modular and scalable, allowing customers to select from and combine a number of components based on the application and specific demands.

This is a single-source solution, including batteries and software, making it much easier for the customer to use the technology and to apply it to their machines.

Scania's electrified power systems will be beneficial in a variety of applications: A boat working in a harbor, an excursion vessel visiting wildlife and a motor yacht cruising between ports are all ideal applications for the e-machine.

Do you see appetite in the market for other new products?

JF: Yes and no. Simply put, innovation is at the heart of Scania's success. The transport industry is changing fast,

and to drive the shift towards cleaner, safer and smarter solutions, we need to be able to innovate quickly. Innovation at Scania is focused on advancing low-carbon transport solutions. E-machines for electrification, alternative fuels like HVO and biodiesel to reduce CO2 emissions, improving engine design to reduce fuel consumption and launching higher power-to-weight ratio engines like the pleasure rated engines for the recreational yacht market.

We also believe the diesel engine will have a continued impact for years to come; while focusing on our electrification technology, we will continue to offer diesel engines that run on alternative fuels. In addition, the release of Scania's new, redesigned 13L diesel engine platform will further reduce fuel consumption and greenhouse gases for heavy-duty diesel equipment and vehicles. When installed in a Scania truck, this new engine and drivetrain combination has reduced fuel consumption by 8%. While 8% does

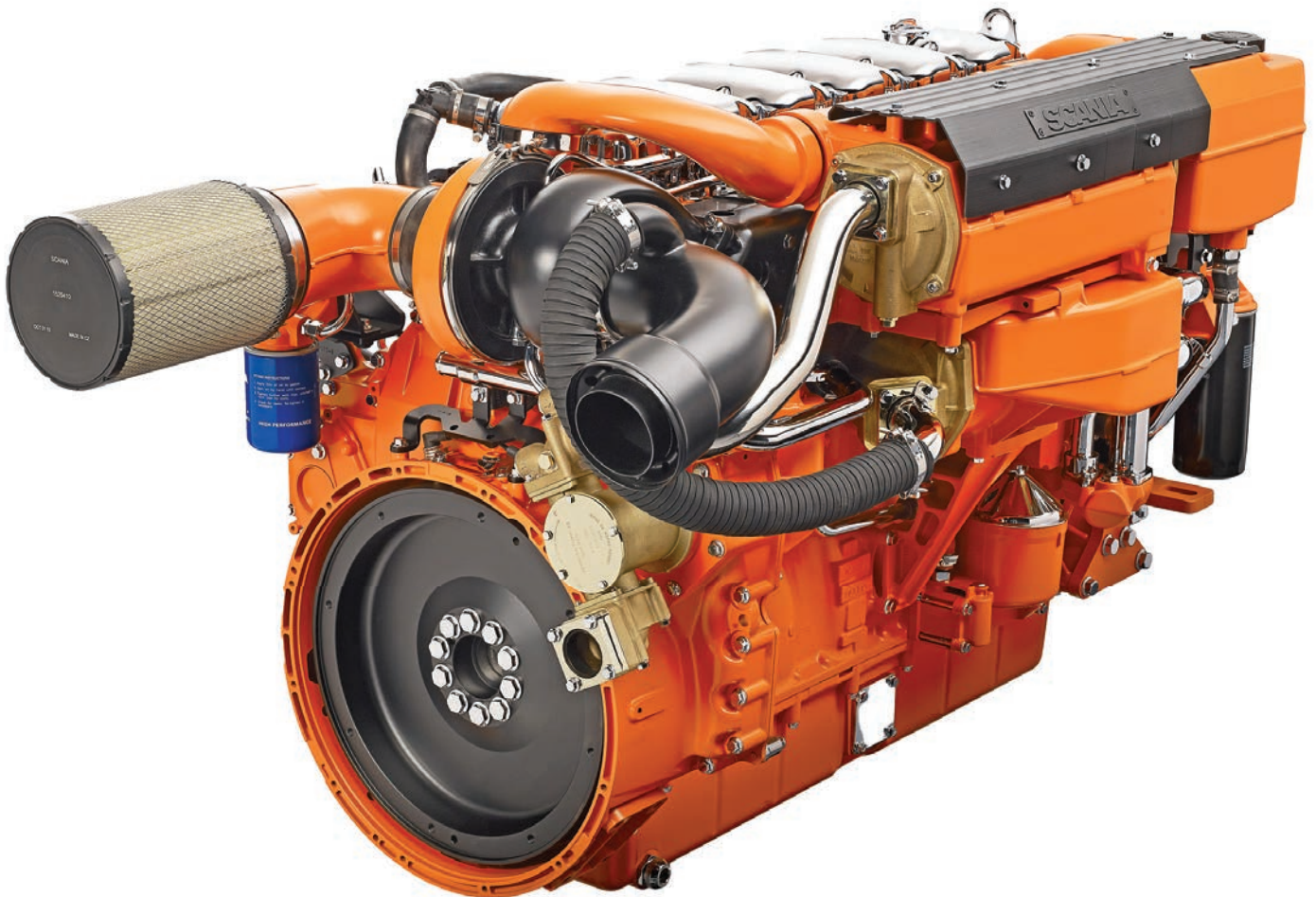

Tell us about your company.

MarineNews wants to hear from you! We are compiling a list of 100 companies who have made waves in the shallow draft market. Apply online and your company could be featured in the October issue of *MarineNews*!



Apply online today!

<http://mn100.maritimemagazine.com>

MarineNews

100

The 100 Leading Companies Serving the
North American Shallow Draft Market

Insights

not sound like much, when you do the math, this amounts to significant savings for our customers.

How do you see the recent CARB harbor craft emissions rule changes in California, and how do they impact Scania?

JF: Scania is responding with a pure electric option for the new and in-use short run ferries. For new excursion vessels, we will offer the plug-in hybrid approach where 30% or more of power is derived from zero-emissions sources.

These regulation changes will also encourage current commercial vessel operators to repower their vessels with newer Tier III engines. By doing so, some operators will be able to utilize their current vessels for up to 10 more years without having to shift to more costly Tier IV technology. Scania's current engine lead times are very favorable, allowing us to respond to these repower requests.

Where do you see greatest opportunities for Scania's marine business in the U.S.?

JF: While COVID has had a significant impact on the market, especially the passenger vessel industry, many of the traditional markets we have been successful in have continued to grow, such as fishing, wind farm support, university research vessels and the pilot boat industry.

As the passenger vessel market rebounds from the pandemic, operators are looking to meet the demand of increased passenger counts, while modernizing their fleet. This includes the growing shift to alternative fuels and fully electric and hybrid applications. We believe that together with our partners and customers we can develop solutions to reach tangible results in reducing our carbon footprint while ensuring that we meet the demands of a growing population profitably and sustainably.

What do you count as your greatest challenges as head of Scania's U.S. business? What are you doing to help tackle these?

JF: As the world rebounds from the pandemic, it will be my top priority to help Scania U.S.A. position itself as the best strategic partner for industrial and marine applications. I hope to achieve this by continuing to mitigate the supply chain issues we are all facing, build brand awareness through distributor and service dealer support and development, and emphasizing Scania's core values of elimination of waste, determination, team spirit, respect for the individual and integrity. It is especially important for our customers to understand they have a partner in Scania, not just a supplier.

What are your top goals for the next 6-12 months, and what's your strategy to achieve them?

JF: While I work to build the relationships associated with my role as President of Scania USA, one of the top priorities in the next 6-12 months will be to introduce Scania's electrification solution and continue to communicate our favorable engine lead times. This will provide our customers with products when they are needed and help ensure our end users have the equipment and vessels they need to keep up with the recovering economy.



List your maritime real estate here!

Contact us today: +1 561-732-4368



Promote a truly unique message with a Maritime Reporter TV interview.

With a Maritime Reporter TV interview, our editorial staff will work to develop insightful Q&A to educate and enlighten viewers about your company's latest advances, technologies and products. Interviews are conducted at events around the world and recorded, produced, and edited by the Maritime Reporter TV staff. The interview will be posted on marinelink.com and promoted to our highly engaged audience.

- Insightful Q&A with the editors of the industry's leading publication.
- Targeted marketing to the industry's largest online audience
- Optional social media boost to the industry's largest social media audience
- Includes all video production along with convenient and easy filming at the leading events around the world

To book a Maritime Reporter TV interview or for more information, contact your sales representative or call +1-212-477-6700.



www.MarineLink.com





Do California's Proposed Harbor Craft Rules Threaten America's Supply Chain?

By Martin Curtin, Founder & CEO, Curtin Maritime

Americans became aware

of our nation's supply chain problem when they witnessed a hundred cargo ships anchored off the ports of Long Beach and Los Angeles, stymied from moving cargo to store shelves throughout the United States. Such circumstances could become all too common, especially as recently adopted engine emission regulations force maritime companies out of the country's most impacted ports, or limit their ability to expand operations as America's demand for imports and exports grows.

Tugboats and barges support California's essential role in global trade by moving millions of tons of freight, all while their owners prioritize reducing engine emissions. These vessels have an environmental advantage over other

modes of freight transportation, emitting 43% less greenhouse gases than rail and more than 800% less than trucks that move cargo over California's already congested roads. Innovation is equally important in our industry—electric tugboat research is ongoing, helping us achieve Governor Newsom's climate change goal of zero-emissions.

The California Air Resources Board (CARB), a board largely appointed by Governor Newsom, is tasked with assessing the health risks associated with engine emissions, and rightly so. Unfortunately, CARB's recently adopted commercial harbor craft (CHC) regulations depart from a long-standing incentive-driven approach to improving air quality.

The regulations, which could go into effect next year,

OpEd

Emissions Regulations

discount the importance of best available science, economic feasibility and public safety. CARB's regulations mandate engines and technology that either do not exist or are too large, requiring vessels to undergo major reconstruction or worse yet, cause vessels that cannot structurally comply to be removed from service. The cost of compliance is in the millions of dollars per vessel, well beyond the reach of most family-operated businesses.

Experts in the field believe this new approach results from CARB's flawed engine emission data. CARB inflates the number of vessels and the time they spend in regulated waters, and fails to understand how vessels operate. We are concerned that they overstate health risks, especially when assigning health risks to vessels that spend a majority of their time many miles from shore.

The use of diesel particulate filters (DPFs) required by CARB compounds safety risks. Currently, there are no DPFs for commercial marine applications. DPFs found on tractor trailer trucks have been known to cause inopportune and dangerous decreases in engine performance for extended periods of time as filters clog, and in some cases, catch fire. Such incidents could be life threatening at sea and pose a secondary threat to vessels containing petrochemical products as fuel or cargo. Our mariners cannot just pull over or get out and walk away like truck drivers do when their DPFs malfunction. Before mandating DPF, the technology should be certified by engine manufacturers and the U.S. Coast Guard as safe.

To be clear, the industry never called on CARB to abandon its goal of updating current air quality standards. In fact, many vessel owners would have supported more stringent regulations provided the technology was available and the compliance timeline was reasonable.

Unfortunately, CARB passed unreasonable amendments. Now vessel companies question whether the State's Carl Moyer Program, which provides grants for lower emission engines and vessel replacement, is prepared for unprecedented demand for funding. The state program is seriously underfunded and historically the local air districts that allocate the funds favor other industries. Our industry alone will require over \$1.3 billion dollars to replace engines, which does not account for the expense of vessel replacement (\$15-\$25 million per a tug) and emerging technology.

Moreover, CARB assumes that engine manufacturers can meet the immediate need for engine technology that currently does not exist, and that ship builders located in other states are prepared to accept boat orders and can make deliveries by the time the regulations start going into effect in January 2023.

If the Newsom Administration is to achieve its zero-emission goals without causing serious disruption to America's supply chain and increasing inflationary pressures, this is the year for the State Legislature to make sure the Governor's budget sufficiently funds lower emission engine programs and earmarks funds specifically for harbor crafts. Anything short of this will reduce the inventory of operating tugboats, placing America's supply chain at serious risk the next time large cargo ships wait in our Nation's largest ports for harbor escorts.

PYI
INC.

QUALITY MARINE
EQUIPMENT SINCE 1981

PARALLEL SEALING SYSTEM
**COMMERCIAL GRADE
SEALING SOLUTION**

AVAILABLE FOR 3/4" TO 6" SHAFT DIAMETERS

CERTIFIED.

ABE
ABE
CERTIFICATION IS PROVIDED FOR ALL VESSEL REGISTRATIONS

PYI Inc.
12532 Beverly Park Road | Lynnwood, WA 98087
425-355-3669 | www.pyiinc.com

f t YouTube

Column

Autonomous Vessels

Autonomous Cargo Ships and New Collision Regulations

By Alan M. Weigel, Blank Rome LLP

The possibility now exists

for ships to navigate the globe with no one at the helm. This capability has been demonstrated in the United States, Europe and Japan by autonomous workboats, survey vessels, and coastwise voyages by autonomous cargo vessels and ferries with the development of larger vessels capable of making trans-oceanic voyages coming soon. Despite this new reality, aside from a patchwork of voluntary best

practices, there are no international standards for the safe design, operation or maintenance of autonomous vessels.

Recognizing this gap, the International Maritime Organization (IMO) has recently completed a so-called Regulatory Scoping Exercise (RSE) to begin the process of creating a framework for Maritime Autonomous Surface Ships (known as MASS) to enable their safe operation within existing IMO instruments, the most significant being the Regulations for Preventing Collisions at Sea (COLREGS).



Nichols Brothers Boat Builders

What is a MASS and are they regulated by the COLREGS?

The IMO defines a MASS as a vessel which, to a varying degree, can operate independent of human interaction, up to an including a fully autonomous vessel with an operating system that makes decisions and determines actions by itself with no seafarers on board. COLREGS Rule 3(a), on the other hand, defines a vessel to include “every description of watercraft . . . used or capable of being used as a means of transportation on water.” Further, the COLREGS applies to “all vessels upon the high seas” and “in waters navigable by seagoing vessels.” Despite some commentators’ arguments to the contrary, it appears from its plain language that the COLREGS definition of a vessel is broad enough to include MASS.

Why focus on the COLREGS?

Despite the rapid development of autonomous vessel technology, for a long time, the large majority of world’s fleet will still be manned. But, with autonomous vessels already plying the world’s navigable waters, it is evitable that manned and unmanned vessels will interact regularly. The IMO has recognized this new reality. The scoping exercise identified the need to amend the regulatory framework of the COLREGS to govern MASS’s “interaction and co-existence with manned ships.”

The question for the marine industry and autonomous vessel developers then is: whether collision avoidance can be automated? Can the industry reconcile the existing collision avoidance rules with what has been called a “paradigm shift” to vessels navigated with little or no human involvement? The current rules rely on human senses and decision-making faculties. But autonomy relies on technology for information acquisition and decision making. The challenge with be replicating the human capabilities with artificial equivalents in a way that is understandable and predicable by the operators of manned vessels.

MASS COLREGS challenges

One challenge to reconciling MASS COLREGS compliance is how autonomous vessels will observe other vessels. The COLREGS use lights and sounds to signal the presence, aspect, and status of own ship and others. Bridge watch standers complying with the COLREGS detect



TORSIONMETER.COM

The ShaftMaster 6000

HP & RPM SYSTEM CONSOLE METER SCREEN 2 INITIAL SCREEN WHEN OUT TO SEA



Screen with specific Fuel Consumption with Micromotion Fuel Flow
Instant and Average Shaft RPM
Instant & Average Shaft Horsepower
Average Shaft Torque
Total Shaft Horsepower Hours
All data goes to Micro SD chip and interfaces to laptop or desktop with time and date stamp and opens in Excel. Great for sea trials without having field service.
Many other screens and data and functions
Remotes can be upgraded to scoreboard type displays

Shaft RPM standalone system

Instant Shaft RPM
Average RPM Screen 2
Total Revolutions, Direction of Shaft, Shaft Stop, Jacking (Turning) Gear.
Micro SD chip for recording data
RPM and Fuel Curve with Micromotion Fuel Flow meter or other.
Other Data available.

REMOTE F4 SCREEN FOR AHEAD WITH MANUVERING RPM



603-566-4330 Rodney

603-860-8317 Mark

AHEAD TANK™

Treating No.2 Easy to Do

**USCG Certified Type II Marine Sanitation Device
& IMO MEPC .227 (64) Sewage Treatment Plant**

Made in the USA

AHEAD Sanitation Systems

NEXT GENERATION TECHNOLOGY
of Integrated Marine Sanitation
Systems & Products

Visit us at www.aheadsanitationsystems.com
or
Call 1 337 330 4407

Column

Autonomous Vessels

light and sound signals from other vessels by maintaining “a proper look-out by sight and hearing.” These other vessels are deemed to be in sight of one another only when “one can be observed visually from the other.”

Congress’s enactment of the COLREGS as the Inland Navigation Rules explained that the rules “do not intend the use of electronic observations, such as those obtained from radar, to be a substitute for visual observations.” Similarly, U.S. courts have held that only visual observations made with the human eye meet the in-sight requirement and that the requirement cannot be met by radar observations.

MASS, however, are fitted with electronic equipment such infrared cameras for the detection of other vessels. Is the detection of another vessel by such a device a “visual” observation under the rules? And how much of the other vessel must be observable by such a device before the vessel is deemed to be “in sight”? Under the present rules, a single light might be enough, but will it be enough for the artificial intelligence running an autonomous system?

In addition to presence and status, the COLREGS use sounds to signal maneuvers or intentions of own ship and others. For example, under the COLREGS, one short whistle blast means “I am altering my course to starboard.” In addition, in U.S. waters, a radiotelephone is required on power-driven vessels of 20 meters or over in length, and when necessary, the bridge watchstander is required to transmit the intentions of his vessel and other information necessary for safe navigation. U.S. courts have consistently held that the failure to use sound signals properly or monitor the radio and respond to calls is a basis for liability for any resulting collision. It remains to be seen if speech and/or sound recognition technology implemented in an autonomous vessel will suffice to comply with the rules.

The final challenge to autonomous COLREGS compliance is how to quantify the “ordinary practice of seamen.” Key terms in the COLREGS are undefined and often depend on the specific approach situation. For example, there is no COLREGS definition for what constitutes “risk of collision,” “close-quarters,” or passing at a “safe distance.” But autonomy requires quantifiable definitions that can be programmed into a computer algorithm. How an auton-

omous vessel will be programmed to apply such definitions and exercise seaman’s “judgment” is not established.

The RSE COLREGS conclusions

The IMO concluded that MASS represents a big “shift” and the “most future concept” in shipping and their operations will result in a “distortion or a lack of clarity within COLREGS.” They concluded that for automated operations with seafarers onboard, they should develop “equivalences” or “interpretations” of the current rules but amend the COLREGS for autonomous shipping without seafarers on board. This approach, however, is not without problems. Left unanswered is what terminology needs to be addressed, what performance standards are needed, and what lights, shapes, or sound signals should change. Further, it is not clear that equivalencies are authorized by the COLREGS, which only provides strictly limited “exemptions” for vessels of “special construction or purpose” that are unable to comply with the rules for lights, day shapes, and sound signaling appliances. Rather changes to the COLREGS must be by amendment, leaving it uncertain if the approach proposed by the IMO is on a sound regulatory basis.

COLREGS and MASS: A possible way forward

The IMO scoping exercise sensibly concluded that for MASS, “the COLREGS in its current form is still the reference point and should retain as much of its current content as possible.” With this directive in mind, the simplest and most direct way to deal with MASS is to amend the COLREGS to provide special lights, shapes, sound signals to identify autonomous operation. Along with this, it would be beneficial to add a new designation to AIS to identify autonomous operation. With the COLREGS amendment, the IMO should add a new COLREGS Annex specifying the technical requirements for autonomous systems, including quantifying the required detection and stand-off thresholds for approach situations, and specifying decision points for avoidance maneuvers. The goal of autonomous COLREGS compliance should be for the artificial intelligence at the heart of the system to be “explainable,” with every decision made by the system transparent and auditable by flag states and class societies.

FLOATING PRODUCTION SYSTEMS BUSINESS INTELLIGENCE

FPSOs • SEMIs • SPARs • TLPs • FLNGs • FSRUs • FSOs

The deepwater sector is rapidly accelerating out
of the great market downturn!

Get everything you need to make smarter decisions with
World Energy Reports.

MARKET FORECASTS • INTERACTIVE DATABASE • RESEARCH ASSISTANCE

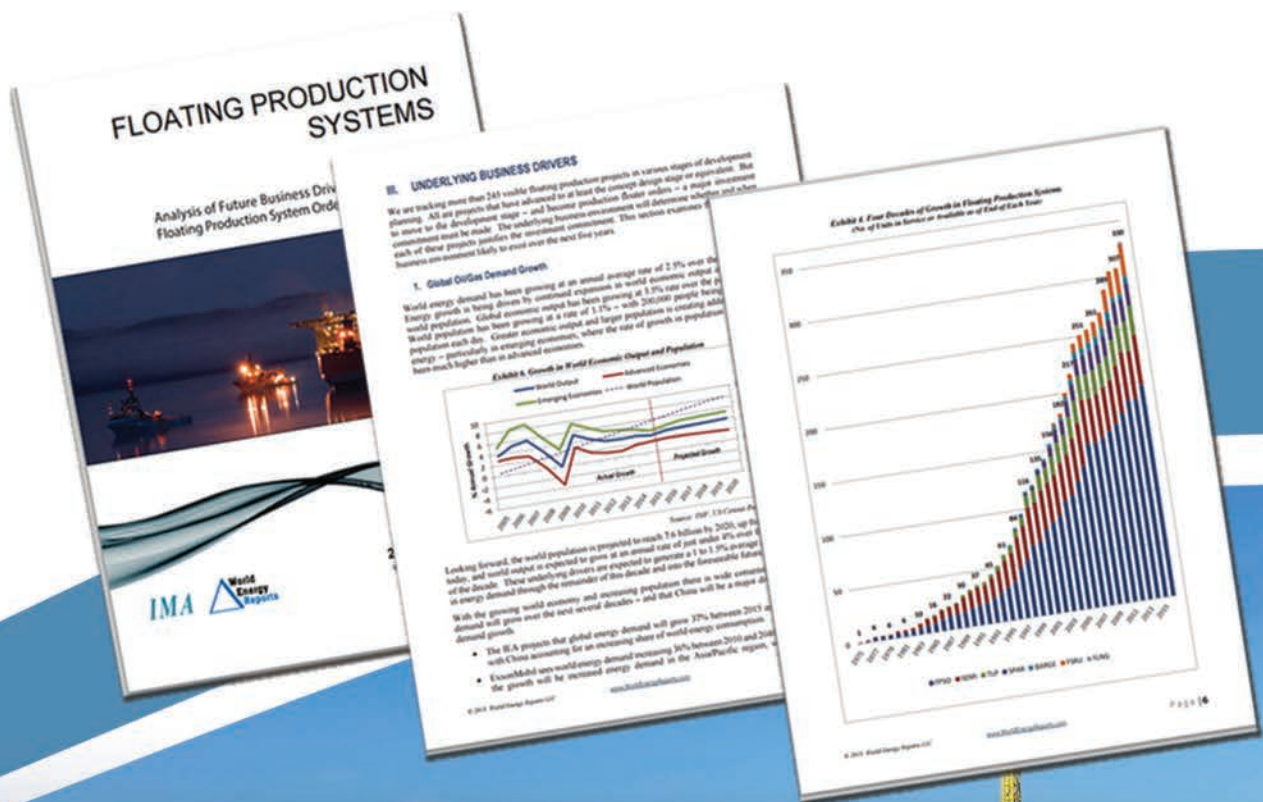

Access this growing market today!

Call +1-212-477-6944 or
email: info@worldenergyreports.com
www.worldenergyreports.com

Feature Volvo Penta

Volvo Penta



KVITBJØRN USHERS NEW TECHNOLOGY — *AND A NEW BUSINESS MODEL*

By Eric Haun

Background image: Volvo Penta

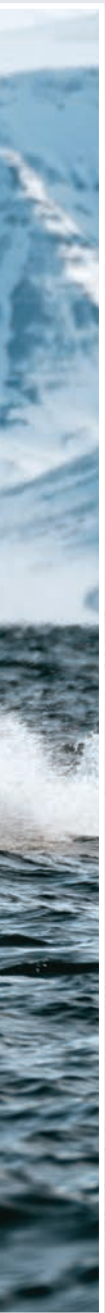

Tore Hoem, adventures director at Hurtigruten Svalbard, has lived on Svalbard, the remote Norwegian archipelago just a few hundred miles from the North Pole, for more than two decades, long enough to witness the sea ice retreat significantly and more rain creep into the early and late snow season.

These alarming effects of climate change are among key drivers behind the Hurtigruten Group's sustainability efforts, including a new hybrid-electric excursion vessel recently put into service in Longyearbyen, Svalbard's largest inhabited area. The 14.9-meter aluminum vessel, Kvitbjørn, built by Marell Boats in Sweden, runs on a hybrid-electric propulsion system developed by Volvo Penta.

Powered by a Volvo Penta twin D4-320 DPI Aquamatic hybrid solution, the boat has a top speed of 30-32 knots and a cruising speed of 24-25 knots, with a range of 500 nautical miles. Volvo Penta's "helm to propeller" package for the vessel includes the engines and drivelines, the electronic vessel control (EVC) system, joystick control, dynamic positioning system and the driver interface. The capacity of vessel's lithium ion batteries is 100 kilowatt-hours (kWh).

Given the current state of technology, electrification is not an option for every vessel. One must consider the use case to determine if a hybrid or full electric setup makes sense. For Kvitbjørn, which will be used for 3-4-hour sightseeing tours, batteries combined with diesel engines fit the bill.

This wasn't the only option, of course. According to Hoem, Hurtigruten had considered ordering a vessel with other propulsion arrangements such as more traditional outboard engines, but ultimately opted for Volvo Penta's hybrid-electric solution based on its environmental advantages, as well as the improved passenger experience.

Kvitbjørn's tours out of Longyearbyen will provide an opportunity for up to 12 passengers to experience the spectacular Arctic seascapes and landscapes, as well as Svalbard's true residents: its natural wildlife, which includes polar bears, reindeer, puffins, seals, walrus and whales. The objective isn't to cruise at 50-plus knots, it's to give guests the best possible journey, Hoem explained. "The key to that, in many ways, is silence."

Kvitbjørn can be operated in three modes: full diesel, diesel with electric assist or all-electric, the last of which provides for a quieter ride that is much more pleasant for those on board and less disturbing to the pristine sur-

rounding environment.

"It's sort of a paradox to take guests out to a glacier front with noisy engines running. That silence is maybe the coolest thing about this [vessel]," Hoem said. "Of course, we go from A to B with some noise and diesel, but when we are at the destination it's quiet. And that's the key here, together with the sustainability part."

And while diesel-electric wasn't the only option, it certainly wasn't the easiest either. It took a healthy dose of engineering to pull it off, Jonas Karnerfors, sales project manager at Volvo Penta, explained. Among key challenges were finding a way to fit the large, heavy batteries withing the Marell M15 hull. The team also had to come up with a way to heat the batteries—rather than cool them, as is common in other environments—to ensure they maintain an optimal temperature withing the frigid Arctic waters, Karnerfors said.

Kvitbjørn comes amid wider sustainability efforts being led by both the Hurtigruten Group and Volvo Penta in parallel with tourism and marine industry peers striving to reduce their environmental impacts. Increasingly, hybrid and electric propulsion solutions are gaining interest among marine operators working to slash emissions across various sectors.

"Our vision as a company is to be a world leader in sustainable power solutions," said Johan Inden, president of Volvo Penta's marine business unit.

Volvo Penta, as part of the Volvo Group, has committed to having a climate neutral impact by 2050. The company aims to offer a broader range of hybrid and full electric products to the market by 2025, and Inden said Volvo Penta sees 2030 as a "tipping point" for the uptake of green propulsion technologies in the marine industry.

According to Inden, Volvo Penta's "helm-to-propeller" approach better positions the company to achieve its sustainability goals by allowing it to have greater control over maximizing the vessel's overall efficiency. "The platform that we've developed is a combination of software systems, integration between all the parts of the propulsion system with very effective drives and propellers. It gives us a very unique position."

Inden said that the drive system in particular is often underestimated as a necessary piece of green propulsion solutions. "The more effective you are getting your power in the water, the less of a footprint you'll have," he noted.

As Kvitbjørn goes to work, Volvo Penta will analyze fuel savings and emissions reductions enabled by the hybrid-

Feature

Volvo Penta

Volvo Penta



Tore Hoem,
*Adventures Director at
Hurtigruten Svalbard*

The Volvo Penta DPI package features a hydraulic clutch for silent and smooth shifting at low engine speeds, as well as added maneuverability. With steer-by-wire technology, the joystick functionality is also precise, delivering greater control. Kvitbjørn also has a joystick on the aft deck so a guide can steer the vessel from outside during a tour.

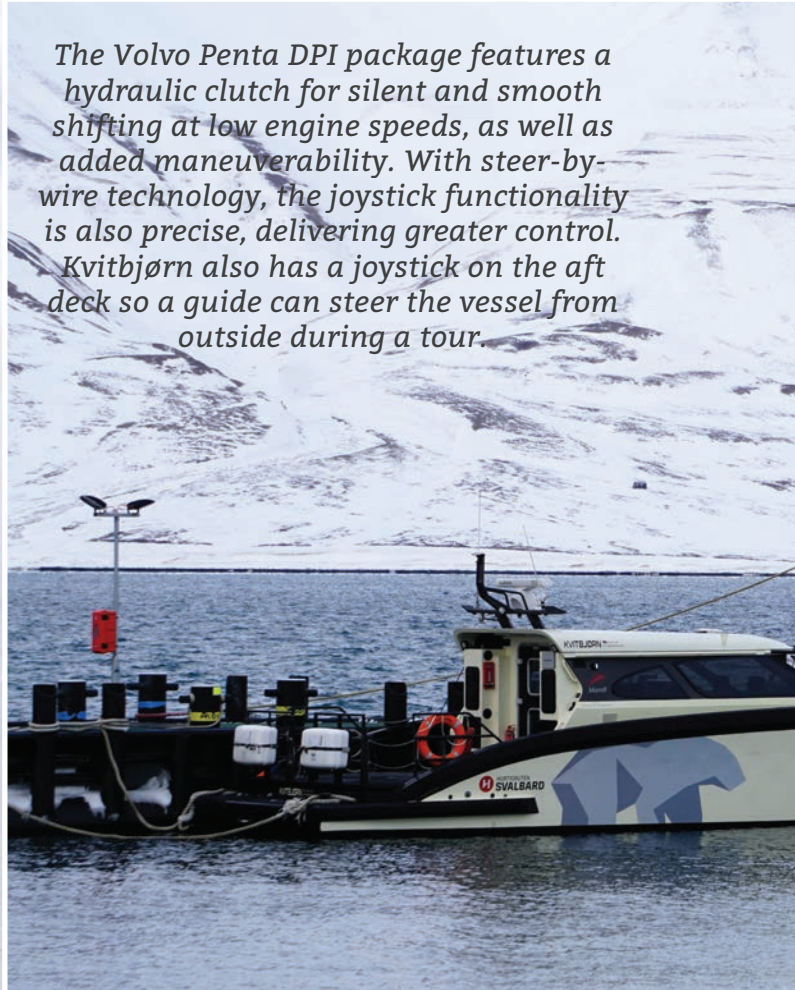

electric solution, Inden said.

In addition, over the course of the next three years, the companies will test the hybrid propulsion technology as well as Volvo Penta's new "e-mobility-as-a-service" business model, which will see Hurtigruten Svalbard pay by the kilowatt-hour for the vessel's operation. According to Volvo Penta, this payment model, while still at a concept stage, has been conceived as a way of risk-sharing with the end-user as marine electrification solutions are typically costlier.

Inden said this model could be especially attractive in the commercial marine sector for workboat owners and operators looking to go green. "You don't have to make a huge investment. You go to the bank, you finance it and then you amortize. You can actually use the vessel and pay for it at the same time as you earn your revenue," Inden said. "That's an inter-

esting aspect from a business model and financial perspective, but even more so, it engages us with the customer in a different way, and there is a different responsibility from our side."

Throughout the three-year contract period, Volvo Penta will deliver the driveline as a service; it still owns the equipment. The boat is separated from the driveline from a contract perspective, Inden said. In this case, Volvo Penta will monitor the drivetrain and maintain responsibility to ensure it remains operational. "It's not that we handed over a vessel and then the customer calls us when something is wrong. Now we're a bigger part of the operation," Inden said. "As we evolve this over time, hopefully, an operator or captain will feel that we are a closer partner to making sure they're up and running. That is a real benefit to this."

But there are still questions to be answered. "In this setup,

Feature Volvo Penta

Eric Haun



Eric Haun



From left: Johan Inden, President of Volvo Penta's Marine Business Unit, and Jonas Karnerfors, Sales Project Manager at Volvo Penta

we are piloting and we are testing,” Inden said. “We want to understand how it will work in real commercial operation—insurance, additional financing, responsibility, data protection, et cetera. That is really what we’re trying to nudge here to get that discussion going. And we don’t know the solution. We don’t know where it will go exactly. But we are sure it’s moving in that direction, so we need to understand it.”

In the event that Hurtigruten Svalbard opts out at the end of the three years, the setup is so that Volvo Penta can exchange the equipment for a regular driveline. “It’s very safe in that perspective,” Inden said. “You always have to think 360 degrees when you do something like this. What are the options for all the involved parties? Can we do this safely? Can we do it with productivity and uptime for the customer? I hope they will be excited to continue, but let’s see.”



Volvo Penta

Feature

Batteries

Eric Haun

A battery rack inside Maid of the Mist's fully electric tour vessel James V. Glynn. The lithium-ion battery packs were supplied by Spear Power Systems.



By Tom Ewing

Batteries for maritime power picked up big momentum in May, benefiting from the most basic concept within Econ 101: supply and demand.

On May 19 Corvus Energy announced it would establish a lithium ion battery manufacturing facility in Port Bellingham, Wash., just north of Seattle. Corvus Energy is a leading supplier of battery energy storage systems (BESS) for marine applications. Its systems already power more than 30 North American vessels, as well as 29 hybrid port cranes and 11 land-based drilling rigs.

Geir Bjørkeli, Corvus CEO, said the company has “seen a significant uptake in orders from the U.S. market as well as a growing commitment from the government and industry players on reducing GHG emissions. Increased capacity and production flexibility will be key to meeting anticipated growth.”

The new facility will have an annual capacity of 200 MWh of stored energy capacity. Individual vessels typically have a capacity between 0.5 and 10 MWh installed, explained Sveinung Ødegard, Americas president at Corvus Energy. Corvus’ goal is to start delivery from a new factory in Q4 this year.

In its announcement Corvus cited increased demand from the tug industry.

Also on May 19, Houston-based Industrial Service Solutions (ISS) announced it is seeking bids from U.S. shipyards to build up to four hulls for what will become North America’s first fully-electric towboats. The zero-emissions vessels, which will be constructed for New York-based Zeeboat and available for charter from 2025, will run entirely on battery power, without the use of diesel engines—a first for towboats in North America. The batteries for this project are already sourced—from Shift Clean Energy, based in Vancouver, B.C.

These announcements continue to confirm that maritime battery applications are moving out of the experimental stage, that vessel electrification is available and in demand.

[For a demonstration, including discussion, of a large scale maritime ESS project check out the video of a battery-powered ferry making a 4-kilometer crossing, 46 times per day, every 15 minutes, between Helsingborg, Sweden and Helsingør, Denmark. The ferry pauses to charge on each side. It transports over 7 million passengers and nearly 2 million vehicles annually—clearly a battery powered workhorse. Of particular interest, note the giant shoreside charging device.]

US trends

Ben Wrightsman is President and CEO of the Battery Innovation Center (BIC), based in Crane, Ind. The BIC works for the development, testing, commercialization and advanced learning of high-performance and lightweight energy storage systems for commercial, defense and industry partners. BIC works closely with the Navy’s high-energy focused Naval Surface Warfare Center, also located in Crane. BIC signed on as a DOE “team member” for DOE’s battery innovation initiative, announced in May, the Agency’s \$7 billion, five-year effort, focusing on battery materials processing and manufacturing.

In an interview Wrightsman commented that maritime battery applications, indeed, have reached an off-the-shelf status, but he still characterized the U.S. market as “pilot scale”, at least compared to European and Asian markets.

Wrightsmen said that the battery supply chain presents challenges. Lithium costs have increased, and future demand will add pricing pressures. Raw materials are available today, but he expects supply risks by 2030. “If you don’t change anything,” he noted, with particular reference to the U.S. regulatory process, “we run risks of shortages. We need domestic production.”

Regarding safety, Wrightsman believes today’s batteries are “inherently safe” and that safety advances will continue, although at a cost. However, he said that overall declining costs will offset safety related increases. For comparison, he noted that fossil fuel systems, after 100 years, present numerous safety risks, from handling to storage to final combustion. Still, these risks are considered acceptable today. He expects a similar safety pathway for batteries.

The future: How fast is it approaching?

Batteries are expensive, heavy and can present extreme hazards—and they need to be recharged. Batteries—really electric storage systems (ESS)—require extensive shoreside infrastructure. And if batteries are to be part of a green energy transition (why else make such a move?) that shoreside infrastructure needs to be connected to constant, unvarying and on-demand supplies of renewable electricity, including utility scale storage; in effect, batteries charging batteries. Even for niche operations in a harbor, it can’t be questioned when a vessel—not to mention 100 vessels—need maximum power, simultaneously.

“State of charge” (SoC) is an important concept in bat-

Feature

Batteries

ISS

Industrial Service Solutions is seeking bids from U.S. shipyards to build up to four hulls for what will become North America's first fully-electric towboats.



tery science, referring to the level of charge of an electric battery relative to its capacity. State of charge is an idea that raises questions about obsolescence. If a workboat, for example, lasts 30, 40 even 50 years, decisions about today's battery power and ESS are not without risks for vessel owners. In 5 to 10 years, today's top-shelf tech could be outdated and uneconomical. And there are corollary risks, e.g., if related shoreside equipment and utility generation does not develop as needed, or as expected, a battery powered vessel could become a "stranded asset."

The Maritime Battery Forum, established in 2014, is a membership group that works to "promote battery-based value creation and make batteries a success within the global maritime market." Members include Corvus Energy, Damen Shipyards and Caterpillar Marine as well as much newer, specialized companies such as Aviloo and Beyonder.

The Forum's website has a freely available, two-page simplified guide about batteries: "Which battery for your ship?" The guide covers the concept of battery "building blocks" and system designs and applications. It presents the central ideas inherent in thinking about and evaluating batteries and ESS performance. For a company starting an initial look at investing in a battery/ESS vessel, the guide

can help project managers develop the right questions to ask so that further research remains productive and timely.

Questions about state of change—and how close significant change may be—also arise from a review of work within a new Dutch consortium focusing on industrial scale batteries and ESS. The consortium, formed last October, is called the Battery Competence Center and it includes universities, trade associations and private sector companies, including DAF Trucks, ELEO and Damen Shipyards. The Center is subsidized by REACT-EU; members contribute via fees.

One goal of the center is to "build up knowledge and competency in the field of battery technology." The center wants related economic benefits to develop in the Netherlands, to decrease dependence on Asian suppliers.

For Damen Shipyards the center offers "an opportunity to apply knowledge from the automotive sector, which is way ahead of the maritime sector in the field of electrification, in the shipping industry," said Peter van Terwisga, with Damen.

R&D is another priority. Looking ahead, the center will focus on the development of complex production processes and machinery. Other topics include thin-film

Feature Batteries

Master Boat Builders

Spartan is the first of two new hybrid diesel-electric tugs built by Master Boat Builders for Seabulk.



technology and plasma chemistry, two specialty fields which the center says must advance in order to develop “a new generation of battery cells.”

Peter Rampen, principal research engineer with Damen, was asked how ship owners should balance questions about new technology, possibly very close at hand, versus moving ahead with current tech. He said that shipyards today can “build safe and reliable battery ships” using “off the shelf” technology, although that availability primarily includes ships with relatively limited demands for power and range.

Rampen cited a number of ongoing ship-battery challenges. He said maritime engineers have limited experience with battery technologies and a limited regulatory scope requires a risk-based approach for every project.

Among R&D teams he cited a number of priority issues. To advance

**INNOVATIVE.
UNIQUE.
PROVEN**

ALLAMERICANMARINE.com
Bellingham, WA | 360.647.7602

Pictured: Blue Manta - 73' Innovative Research & Ocean Floor Survey Mapping Vessel for Bluetide Puerto Rico

The advertisement features a photograph of the Blue Manta, a white research vessel with blue accents, on the water. The text is overlaid on the image. At the bottom, there is a small logo for All American Marine, which consists of a stylized boat with red and white stripes.

Feature

Batteries

Battery Innovation Center

Jonathan Angelo is Advanced Battery Manufacturing Engineer and Education Coordinator at the Battery Innovation Center. He demonstrates the Calendering machine, a process to densify electrodes in order to increase a cell's energy density.



safety he sees the need to develop batteries in which fires and explosions from “thermal runaway” can’t happen, or the odds are drastically lowered. Newer designs will require fewer safety precautions, allowing more compact and easily configured systems.

Standardization, Rampen said, will decrease costs. Modular and scalable batteries will draw a wider variety of ship types. The building block concept will offer the flexibility needed to use fewer types of batteries—but batteries that can be produced in large quantities—for an increasing number of vessels.

Another important goal is to develop shared production across differing transport industries and modes, e.g., ships and trucks, or even using the same battery modules. Finally, battery recycling is critical for keeping ESS sustainable.

“Current Direct” is a European battery project, funded by the European Commission’s Horizon 2020 program, expected to move to demonstration phase in 2023. It will deploy containerized battery blocks to repower harbor and river vessels. The goal is to replace, at designated harbor sites, a spent power pack with one fully charged, all within five minutes.

Shaun White is Current Direct Project Manager and Senior Project Manager at marine battery manufacturer Spear Power Systems. White said that Current Direct is on schedule for its 2023 demo. He said battery research has focused on thermal and structural materials to evaluate flame and integrity tests.

White explained that maritime batteries have different utilization profiles than automotive or grid-storage batteries, the two applications that have dominated battery development. Work is ongoing now to align battery capabilities with maritime demands. White said that if development work by Blackstone Resources, a CD partner, is successful those advances will increase energy density and lower some process costs by half.

Readers may be interested in reviewing Current Direct’s “Voyage Energy Planner,” a zero emission web tool developed for inland waterways fleets.

DOE’s big moves

The U.S. Department of Energy is making significant moves to spark battery development. Utility-level energy storage is one of DOE’s Earthshot initiatives. As noted above, DOE will spend \$7 billion over five years on battery

Feature Batteries

supply chain issues. This work isn't singularly focused on maritime applications, but it will impact all transportation sectors. Critically, DOE wants related economic activity to take hold and expand in the U.S., so that U.S. citizens and markets benefit from the green energy transition.

In May, DOE announced plans to provide grant funding for research partnership projects that will establish the pathways to deliver lithium batteries to power transportation the way lead batteries are ubiquitously available to support transportation.

DOE writes that "batteries are a critical element to decarbonizing our economy and national competitiveness—for grid storage, for the resilience of homes and businesses, and for electrification of the transportation sector." DOE

projects that the lithium battery market will increase "five-to ten-fold by the end of the decade" and that it is "essential that the United States invests in accelerating the development of a resilient supply chain for high-capacity batteries." These projects have to address other areas, including social goals, workforce opportunities and impacts on low- and moderate-income communities.

DOE is focusing on demonstration projects that fall into 12 "areas of interest," including commercial scale cell manufacturing, extraction and processing, "next generation" materials and electrodes and commercial scale battery recycling. Each project area must be domestically focused.

Watch for decisions about project funding by the end of 2022 or early next year.



CLEAN GULF
CONFERENCE & EXHIBITION
*Real-World Solutions for Spill Prevention,
Preparedness and Response*

NOVEMBER 8-10, 2022
ERNEST N. MORIAL CONVENTION CENTER • NEW ORLEANS, LA

Register with **VIP code: MNEWS**
to save \$100 on registration

WWW.CLEANGULF.ORG

The banner features a dark blue background with abstract geometric shapes in shades of blue and green. A large, stylized white and blue arrow points from the right towards the center. The text is arranged in a clean, modern layout with varying font weights and colors (white, blue, green) to create visual hierarchy.

Feature

Alternative Fuels

All American Marine

HYDROGEN AS FUEL:



Possibilities, but...

By Tom Ewing

Hydrogen is everywhere. You know that from high school chemistry. And you also know it from *Marine News'* almost daily updates about H powered vessel projects around the world.

As a fuel that could potentially replace fossil fuels, H is in the spotlight. Perhaps the brightest spotlight, at least in the U.S., is within the Department of Energy's "Energy Earthshots" initiative.

R&D on H was the first such Earthshot announced last year. DOE wants the "Hydrogen Shot" program to "accelerate innovations and spur demand of clean hydrogen by reducing the cost by 80%."

Note the reference to "clean" hydrogen. Currently, U.S. industry produces several million cubic feet of H daily, used for industrial applications such as refining, treating metals and food processing. H is produced using high-temperature steam ("steam reforming") and via electrolysis – splitting water into H and oxygen. Each process is energy intensive and expensive, usually fueled by natural gas. The conundrum has always been: why use H as fuel when natural gas is so cheap? The carbon factor forces a different perspective. If clean H could be generated using renewable energy, there could result an almost limitless supply of a fuel that, according to many experts, shares characteristics with natural gas, making H a relatively familiar replacement.

Hydrogen Shot seeks to reduce the cost of clean hydrogen by 80% to \$1 per 1 kilogram in 1 decade ("1 1 1"). To get traction on this, in February, DOE published a request for information on "clean hydrogen manufacturing, recycling and electrolysis technology research, development and demonstration (RD&D)" and a second request pertaining to establishing a number of R&D "Hydrogen Hubs" at various research facilities in the US. One goal is to locate the R&D Hubs in the same city or region as new H production. Then, R&D and production could work together to get H mainstreamed even faster.

The optimism about H, of course, has to be tempered with difficult realities, very difficult realities. Hydrogen is volatile, highly flammable and explosive. It's expensive to produce. Storage and transport are difficult, requiring even more energy to compress the gas into a liquid and then store it at low temperatures. Trying to overcome these challenges involves a mental and physical wrestling

match with the very foundations of chemistry and physics—and economics.

Regulators, not to mention a concerned citizenry, will need to take a deep breath about proposals to transport and store hydrogen. Maybe production could be kept remote, but at some point, a fuel has to move to where it's needed: ports, holding tanks, rail yards, transfer vessels, truck depots, airports. Acceptable risk will be difficult to document.

Some lessons learned

Reports about new H projects are important, of course, but there are also quite a few H projects that have concluded. Do the lessons from those projects confirm the kind of expectant promise inherent in a national initiative like Hydrogen Shot? Here's a closer look at two such H projects with a maritime focus.

Sandia National Lab's Fuel Cell Generator

In 2017, Sandia National Laboratories, part of DOE's network of energy R&D labs, completed a Maritime Fuel Cell Generator Project in Hawaii. This first-of-its kind hydrogen fuel cell (FC) generator was built by Hydrogenics, a company now owned by Cummins, Inc. Young Brothers, the Hawaiian shipping company, agreed to use the genera-

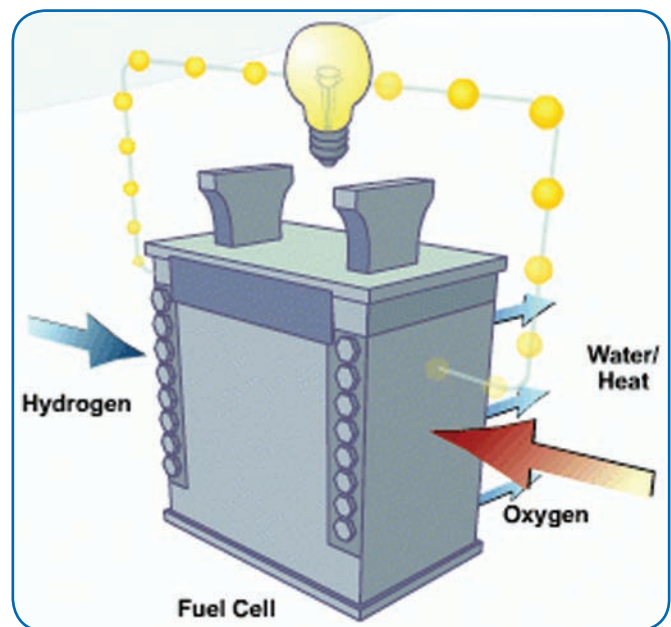

U.S. Department of Energy

Feature

Alternative Fuels

tor to power reefers on the dock and on interisland barges, just as it uses diesel equipment.

A fuel cell uses hydrogen (or hydrogen-rich fuel) and oxygen to create electricity. A polymer membrane is positioned between the incoming H and O₂. The membrane allows the positively charged protons to pass through but not the negatively charged electrons which must flow around the membrane, forming an electrical current.

If pure hydrogen is used as a fuel, fuel cells emit only heat and water, eliminating concerns about air pollutants or greenhouse gases.

Sandia concluded that H generation can reduce maritime related emissions across many applications, e.g., for port equipment, auxiliary power for vessels and vessel propulsion, among other uses.

Still, there were problems—but after all, this was a research project. For example:

- *Inconsistent start-up;*
- *The cells used more deionized water than expected – an “unanticipated inconvenience;”*
- *Hot weather degraded performance;*

- *Refueling was quick and judged safe but pressurized valves didn't always work.*
- *Sandia recommended assigning a staff person to operate and maintain the fuel cell until the technology “becomes as trouble-free as its diesel counterpart.”*

These technical issues were not viewed as insurmountable, and the report concluded, “Projections for full-usage deployments indicate that cost reductions in fuel cell technology, balance of plant items and hydrogen fuel can result in cost parity with diesel generation.”

Reductions with fuel cell costs were viewed as most likely to happen soon. After all, fuel cells have been around for decades, and next-step improvements would be to a familiar platform.

The tougher challenges were the same issues being confronted today, five years later: the cost of the hydrogen and storage (for this project the H was provided free, courtesy of the Air Force).

Additionally, Sandia described challenges beyond the generator. Labor, logistics and legal matters impacted “the



Feature Alternative Fuels

operation of the fuel cell significantly.” New and different safety issues required close attention. The report raised rather unthinkable concerns. One example: that a release of unignited hydrogen might be sucked into a tug’s interior spaces, while the tug was adjacent to the generator, or into the tug’s diesel air intakes. This was eventually judged unlikely, at least with this project. But it exemplifies the myriad of outside-the-box issues raised by the prospect of using a novel and dangerous fuel in a dense work zone and the need to evaluate each issue.

Unfortunately, once completed, the fuel cell project stopped. A subsequent project at the Scripps Institution of Oceanography was derailed by COVID. Now the unit is idle and likely to be decommissioned.

Sea Change

This past February, the Sea Change, the world’s first commercial hydrogen fuel cell, 70-foot, 75-passenger ferry was launched for sea trials in Bellingham, Wash. The Sea Change was built by All American Marine (AAM) for SWITCH Maritime.

The fuel cell was built by Zero Emission Industries, whose CEO/CTO is Joseph Pratt, PhD, a Sandia Labs alum. The power package is comprised of 360 kW of Cummins fuel cells and Hexagon hydrogen storage tanks with a capacity of 246 kg. This system is integrated with 100 kWh of a lithium-ion battery provided by XALT and a 2x 300 kW electric propulsion system provided by BAE Systems. AAM writes that “the hydrogen fuel cell powertrain system affords the same operational flexibility as diesel with zero emissions and less maintenance.”

Joe Pratt was asked about how the Sea Change trials went. He said there were some “typical conditioning things, some having to do with the boat and some with the H fuel cell, but at the end of the day everything worked well.”

Pratt stressed that “H fuel cells are nothing new,” the tech has been in the market since the late 1990s, powering numerous vehicles, from forklifts to buses to passenger cars. “We understand what it’s going to take to get the system to work,” he commented.

Pratt said the next challenge is to streamline production. “Our biggest lesson learned,” he commented, “is that we



THE MSD



TYPE II MARINE SANITATION DEVICE

USCG CERTIFIED
IMO CERTIFIED

PRODUCTS:



4, 12, 16, 24 & 32 PERSON SYSTEMS

Constructed of Lightweight High Density Polyethylene

Noncorrosive, Maintenance Free

A Biological Aerobic Sewage Treatment System

Celebrating Our 20th Year in Business!

Environmental Marine Inc.

Keeping Our Waters Clean

ENVMAR.COM 606-271-2711

Feature

Alternative Fuels

need to make this a lot simpler and go from 300 different steps down to five.” Pratt wants to deliver a fuel cell package like a diesel engine gets delivered. Then, the shipyard can work with a unit, rather than a process. “We want the shipyard to be able to drop them into the boat and connect a few hoses,” Pratt explained. “That’s what we’re working on right now, to make it easy for vessel owners and shipyards.”

The Coast Guard participated in the Bellingham sea trials. CDR Frank Strom, Chief, Systems Engineering Division, Office of Design and Engineering Standards at Coast Guard Headquarters, explained that the CG’s inspections were to “verify compliance with 46 CFR Subchapter T requirements,” focusing on mechanical and electrical systems including propulsion, steering, navigation, and automation. These inspections mostly occur at the pier but an “underway trial,” is also required and, indeed, was completed.

Strom was asked about hydrogen specific issues. He said that current Subchapter T regs do not consider the use of lithium-ion batteries or hydrogen as fuel. The Sea Change is regulated by “a design basis agreement,” he explained, “which serves to augment federal regulations with applicable hydrogen safety and construction standards in order to achieve an equivalent level of safety.” During Sea Change construction, the Coast Guard “verified that the hydrogen and lithium-ion battery systems were performing in accordance with their design, which was made to those standards.” There is no effort under-

way right now to revise Subchapter T to include H or lithium-ion battery propulsion.

Strom explained that the Sea Change crew, as with all vessels, must demonstrate the ability to respond to “fire, flooding, abandon ship, and man overboard situations.” With the Sea Change, verification also included an “assessment of the crew’s hydrogen-specific knowledge and a further assessment of their ability to prevent and respond to all emergencies onboard the vessel, including those associated with the hydrogen fuel system and lithium-ion batteries.”

This process continues when the Sea Change moves to San Francisco, its future port. Then, inspections will focus on hydrogen bunkering, crew training and competency, and operational requirements presented by the use of hydrogen as fuel. The goal is for Sea Change to earn its Certificate of Inspection so that it can carry passengers.

DNV forecast

In June, DNV released an extensive document – Hydrogen Forecast to 2050 - DNV – a close look at hydrogen’s potential to become a central fuel by 2050. The Forecast focuses on Europe, but the advisories are applicable in the U.S., and elsewhere, of course.

DNV estimates that H will provide 5% of global energy demand by 2050, although likely to meet 11% in Europe. The 5% level is too low for H to proportionately contribute to Paris Agreement reductions.



The Hydrogen One towboat, being developed by Maritime Partners, Elliott Bay Design Group, e1 Marine and ABB, will use e1 Marine’s reformer technology to generate hydrogen from methanol on-demand.

Elliott Bay Design Group

Feature Alternative Fuels

In a foreword, written by Remi Eriksen, DNV's group president and CEO, Eriksen comments that in many ways, H "should be thought of as the low-carbon energy source of last resort. However, it is desperately needed (especially) in those sectors which are difficult or impossible to electrify, like aviation, shipping, and high-heat industrial processes." Eriksen writes that safety "must not become (hydrogen's) Achilles heel."

To get H fast-tracked, DNV presents 10 key considerations for policymakers. These reference safety gaps, "demand-side policies" to stimulate "offtake," i.e., customers, new regulations, e.g., carbon taxes, across different energy systems and the need for CCS—carbon capture and storage—at a huge scale.

DOE's next steps

Given the extensive history on H research it's worth asking: How did this body of work inform DOE's request for comments pertaining to directions and goals for Hydrogen Shot?

Unfortunately, DOE won't answer any questions about the public comments it received, not even how many comments were sent in. A spokesperson said that "due to certain sensitivities, specific questions about the RFIs (requests for information) aren't being addressed." The sensitivities were not detailed.

Sometime between 2023 and 2026 DOE plans on selecting at least four regional H hubs. The other tasks—a H Roadmap, a clean H standard, and electrolysis and manufacturing—will be mostly analytical, research based, funded over the next four years.

MCD **McDONOUGH**
Marine Service

OFFICES: CHANNELVIEW, TX - METAIRIE, LA - CHESAPEAKE, VA

75
YEARS OF SERVICE

**THE PREMIER
BARGE & TUG
COMPANY
FOR MARINE
CONSTRUCTION**

Barge Support for:

- Pile Driving
- Bridge Construction
- Dock/Wharf Construction
- Coastal Restoration
- Dredging - Oil Field - Wind Energy

MCD

**THE
BARGE
PEOPLE**

INLAND BARGES | CRANE BARGES | OCEAN BARGES | PROJECT CARGO BARGES | TRUCKABLE TUGS

www.mcdonoughmarine.com | 1.888.569.5929

Profile

Ahead Sanitation Systems, Inc.

Full Speed Ahead

Ahead Sanitation Systems, Inc. is fast becoming a leading manufacturer and distributor of marine sanitation systems, products and supplies after more than two decades serving the industry. Those looking can find an Ahead Tank somewhere across all seven seas and most major rivers and lakes in between.

Winton I. Rebouche, Jr., known to friends and customers as Boo Boo, is the founder and sole owner of the Broussard, La.-based company. In the late '80s, Boo Boo worked selling pipe couplings in South Louisiana's booming oilfield industry and pioneered a technique to recycle old couplings with a machine of his own design. After the largest part of the oilfield industry packed itself up and moved to Houston, Boo Boo decided to liquidate his busi-

ness and got into selling one of the most vital commodities in the swamplands of South Louisiana: houseboats.

At that time, the state of Louisiana began to enforce a new set of laws concerning the dumping of raw and untreated sewage into lakes and rivers. The new rules required all camps and houseboat owners to find some way to deal with the waste they were producing. While the state outlined the problem and what had to be done, it did not specify how to do it. Opportunity came knocking, and Boo Boo quickly took to designing and then manufacturing a sewage treatment system for houseboats and camps, known as the LUS-75 camp unit. His interest in finding an efficient way to treat human waste did not stop there, and he continued to brainstorm a way to rotary mold a polyethelene tank that



Ahead Sanitation regularly ships systems to customers outside of the United States. Shown here are 14 systems destined for customers in Peru.

Ahead Sanitation Systems, Inc.

Ahead Sanitation Systems, Inc.

could be used as a Type II Marine Sanitation Device. Boo Boo took his design ideas to a rotational molder, and after much consideration, the Ahead Tank was born.

Ahead Tank operates as a biological aerobic (bacteria and air) marine sanitation device (MSD). The cost-effective solution works with nature to accelerate the natural biological waste degrading process. Liquid and solid wastes are removed from the water by the bacteria naturally contained in the sewage. The processed water is clean and free from solids; however, the liquid must be disinfected prior to discharging overboard in order to kill any disease-causing bacteria. This biological process is simple, reliable and odor free.

Ahead Sanitation's flagship product, the Ahead Tank, is manufactured 100% on American soil as the only USCG certified Type II MSD that has three individual treatment chambers rotationally molded into the integral structure of a single tank. According to Boo Boo, many said that this was impossible to do, yet his determination and ingenuity brought the unique design to reality. This signature design is imperative in preventing bacteria transfer from one tank to another—something steel tanks cannot guarantee.

Ahead's system is constructed of a durable lightweight, chemical and corrosion proof LLDPE maintenance free material. The company said it uses cutting edge rotational molding technology to set innovative standards and redefine the means of treating human waste.

Ahead Sanitation has more than 1,400 satisfied customers, big and small, from shipbuilders and tug and barge companies, to pleasure boat owners, captains and anyone who likes the color yellow.

Jim Demske, Senior Port Captain with Vane Brothers, Inc. based out of Baltimore, said Vane has been using the Ahead MSD system on nearly all of its new tugs, which number well over two dozen. And the company has swapped out older MSD systems with the Ahead Tank on existing vessels as well. "The Ahead MSD is Vane Brothers' choice for the most reliable MSD system. These MSDs are super reliable. The tanks and components are all lightweight and corrosion proof, something that is key to longevity on an MSD system," Demske said.

Demske also noted the system is easy to install compared to other MSDs on the market. "On newbuilds the shipyards often comment on the ease of installation com-



pared to the older, heavier and bulkier tanks provided by other manufacturers," he said. "If you've ever had one of the older steel MSD tanks fail and you need to remove it, you'll definitely appreciate the lightweight tanks and simplicity of the Ahead Tank design. Chesapeake Shipbuilding, St. Johns Ship Building and Conrad Shipyard (Texas) all agree with me and love installing them," Demske said.

In addition to selling to the mainstream markets, Ahead Sanitation also works with individuals on custom jobs, and customers will often find that they get to speak with the designer and owner himself. Boo Boo recently outfitted a gold dredging barge that will soon be headed to Alaska. Additionally, he is in the process of helping a water taxi company solve its dockside sewage issues.

Boo Boo takes great pride in the products Ahead Sanitation makes and delivers, saying "I treat sh*t, I don't sell it!" He also places great emphasis on top-notch customer service, often going above and beyond to help customers. As an example, when a recent shipyard welding mistake resulted in a melted MSD tank, Boo Boo personally replaced the system so the vessel could get back to work the next day.

Ahead stocks a wide range of macerating toilets, grinders, submersible sump pumps, air pumps and control panels at its 10,000-square-foot warehouse in Broussard, and it carries its own environmentally friendly treatment chemicals called "Sum Uh Dat".

Boo Boo, who is also known for his signature Cajun sauces and seasonings—included as part of every system delivery—said, "Ahead Sanitation has you covered from the table to the toilet. Remember, call Boo Boo if you want to make treating number two easier to do."

Vessels

RB Weeks



Eastern Shipbuilding Group

Eastern Shipbuilding Group, Inc. launched the R.B. Weeks, the second trailing suction hopper dredge the Florida shipbuilder has constructed for Weeks Marine, Inc.

The new 356-foot trailing suction hopper dredge is being constructed at ESG's Allanton Shipyard and has a hopper capacity of 8,550 cubic yards. The vessel outfitting and trials will be conducted at Eastern's Port St. Joe Facility for an on-time delivery in 2023.

The R.B. Weeks is named in honor of Richard B. Weeks, a co-founder of Weeks Marine and married to Magdalen Weeks, the namesake of the sister vessel Magdalen, built by Eastern and delivered in 2017.

In nearly all respects, the R.B. Weeks is identical to the Magdalen. The vessel includes an electrical power, propulsion, and dredge machinery package by Royal IHC, GE Tier IV engines, along with several accommodation and crew comfort upgrades.

Skana

All American Marine has and delivered Skana, a 150-passenger hydrofoil-assisted catamaran for Major Marine Tours. This is the second delivered to Major Marine Tours by All American Marine in two years, and a sister ship to the Spirit of Matushka, delivered in the Spring of 2021. This vessel will also operate out of Seward, Alaska and will carry passengers on tours visiting Kenai Fjords National Park. This 87' (LOA) x 32" Teknicraft Aluminum catamaran, is certified to USCG Subchapter T.

The vessel includes Hamilton Jet AVX controls which boast features such as the use of an intuitive Mouseboat controller. For the operator, one of the most valuable features on this vessel is the excellent fuel economy. With an increased fuel capacity of 1900 gallons, this vessel was upgraded to include a dynamic aluminum hydrofoil, enhancing its speed and efficiency. The propulsion package includes 4x Hamilton Jet HM422 waterjets, powered by 4x Scania DI16 082 engines, rated at 788 bhp at 2,100 RPM.



All American Marine

MSFS Hybrid-electric Ferry

North Kingstown, R.I. shipyard Senesco Marine has been selected by the Maine Department of Transportation to build a new hybrid-electric passenger vessel for the Maine State Ferry Service (MSFS). The 154-foot passenger-vehicle ferry, designed by Gilbert Associates, will be equipped with BAE Systems' electric hybrid propulsion solution to deliver reduced and zero-emission operations capability for the Rockland-based ferry service.

The first hybrid car ferry in Maine will initially provide service from the ferry terminal in Rockland and follows its newly launched sister ship on the Rockland-Vinalhaven line, Capt. Richard G. Spear.

BAE's HybriGen Assist solution includes electric motors, variable speed generators, a battery-based energy storage system and vessel auxiliary power to create a clean, quiet form of propulsion. The vessel will be equipped with Caterpillar propulsion engines and gensets, Reintjes gearboxes and a Spear energy storage system, integrated with BAE Systems' electric motors and power electronics.

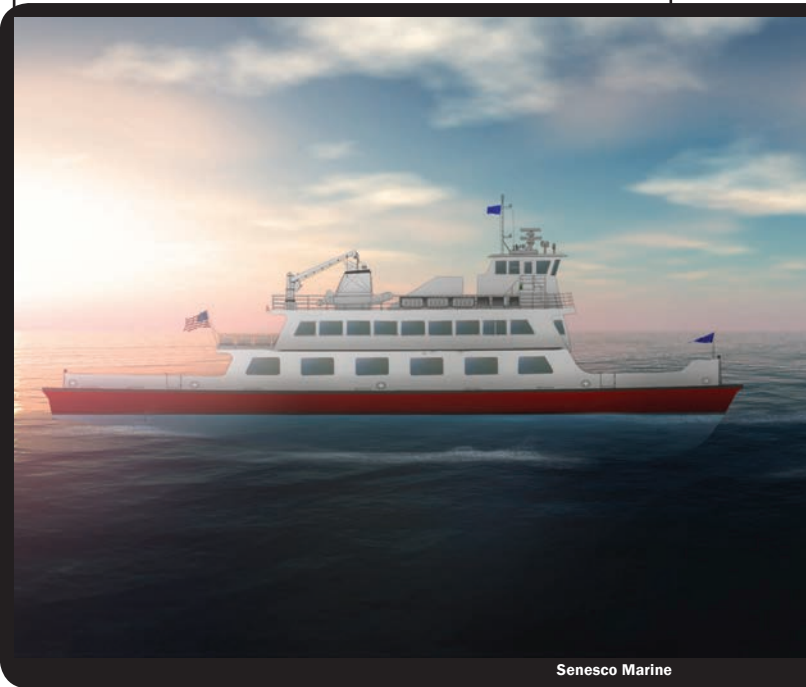

Senesco Marine

Dorado



WETA

A new high-speed passenger vessel entered service for the San Francisco Bay Area Water Emergency Transportation Authority (WETA). The newbuild, Dorado, is the first in a series of four new ferries being built for WETA by Mavrik Marine in La Conner, Wash. Construction on the second vessel in the Dorado class, Delphinus, is underway.

The EPA Tier 4 ferry was designed by One2Three Naval Architects, and construction management services were provided by Aurora Marine Design. Dorado carries 320 passengers and will initially enter service rotating among WETA's routes to collect operational data and allow passengers across the ferry system to experience the boat, the agency said.

Dorado is the fastest vessel in WETA's fleet with a service speed of 36 knots and it is the first boat built for WETA that can safely dock at any of the system's 12 ferry terminals. The vessel has expansive outdoor passenger space to allow more riders to experience a fresh-air trip across the Bay.

People & Companies



Todd



Smith



Webb



Crutchfield



Lim



Delaney



Groff



Millender Bailey



Zimmerman



Zimmerman



Mele



Lakin

AWO Elects New Board

The American Waterways Operators announced Clark Todd, president & COO of Blessey Marine Services, was elected chairman; Rick Iuliucci, VP of The Vane Brothers Company, was elected vice chairman; and Brian Hughes, VP operations & sales, Hughes Bros., Inc., was reelected treasurer.

Smith Named Seaward Services President

Hornblower Group announced Brendan Smith, formerly VP of engineering, NYC Ferry, has been named president of Seaward Services, Inc.

Colonna's Shipyard Promotes Three

Colonna's Shipyard announced Jordan Webb has been promoted to VP of shipyard operations. Randall Crutchfield has been named VP of industrial operations and facilities. Chris Marsh has been appointed executive director of waterfront operations.

Anthes-Washburn to Lead CLT

Ed Anthes-Washburn has joined Coast Line Transfers as managing director.

E1 Marine Names Lim VP

e1 Marine has appointed David Lim to the newly created role of vice president of application engineering.

Cox Grows Leadership Team

Cox Marine announced David Gilbert has been appointed as its new chief com-

mercial officer and Marcus Randall as head of marketing and communications, while Paul Cavander joins as head of industrial strategy and Heinz Stalhammar as chief engineer.

Delaney Joins BHGI

Bristol Harbor Group, Inc. has hired naval architect Braden Delaney.

Hockema Hires Groff

Hockema Group has hired naval architect Matthew Groff, P.E.

Millender Bailey Joins Mercury

Mercury Marine has named Perissa Millender Bailey VP and GM, eSolutions.

New Leadership at FarSounder

Matthew Zimmerman is taking the helm as CEO of FarSounder, while former CEO, Cheryl M. Zimmerman, continues her role as chairman of the board, as well as taking on the position of market development strategist.

Mele Joins MidAtlantic Engineering

MidAtlantic Engineering Partners announced Joseph Mele, P.E., P.P., P.L.S. has joined its team as part of their growth initiative for northern New Jersey and an expansion of services in New York.

Danfoss NA Hires Lakin

Danfoss North America has hired Steven S. Lakin as its new director of public and industry affairs.

Products

1 VETUS



1. RC12HD Vertical Rope/Chain Windlass

The RC12HD has been designed to meet typical classification society requirements and is well suited to vessels requiring high service speeds, such as patrol vessels, as the reduced weight of rope/chain combination reduces weight from the front of the vessel.

<https://vetus.com/usa/maxwell/>

2. In-Mar Solutions: Wynn Marine Type C & Type D, Heavy Duty Straight Line Wipers

Wynn Type C (internal motor) and Type D (external motor) Straight Line Wipers offer the most advanced design of linear action window wiping systems for marine and other specialized applications. Optimum window coverage can be achieved and enhanced by utilizing a twin-bladed or dual-arm/blade design.

www.inmarsolutions.com

2 In-Mar Solutions



3. EALs for SCPs

SCHOTTEL has approved environmentally acceptable lubricants (EALs) for the use in its Controllable Propeller (SCP) units. Following a testing period in the in-house test benches, oils that were able to meet the OEM's performance and quality requirements were technically approved for the use in CP hubs. The EALs are not only able to fully replace the mineral oils used so far, but offer a further advantage with their biodegradability. As a result, they ensure to not harm the environment in the long term.

4. Turbodrives 600 HCT Waterjet

Castoldi launched its largest waterjet to date, the Turbodrives 600 H.C.T., geared for large vessels. It is equipped with an integrated gearbox (certified for heavy duty ratings), with hydraulic clutch, that with its numerous gear ratios allows a match with any engine on the market. The waterjet is also equipped with all bearings oil lubricated, impel-

3 SCHOTTEL

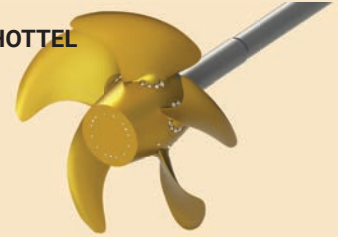

4 Castoldi



5 e1 Marine



ler shaft protected within a housing and the advanced patented Clear-Duct unclogging system to back-flush the intake while opening the protection grid.

5. Methanol to Hydrogen Generator

e1 Marine's M-series methanol to hydrogen generator has received approval in principle (AIP) for marine applications from Lloyd's Register, which has also confirmed that final approval for the technology is possible, including for inland waterways, when following inland waterway regulations. Through e1 Marine's patented hydrogen generation technology, fuel cell-grade hydrogen is generated from methanol and water. It can be delivered on-site, on-board and on-demand for use with fuel cells to generate electricity or to supplement the standard fuel of a conventional engine.

January 2022

Workboat Propulsion

- Passenger Vessels
- Distance Learning: Remote Classroom, Simulation, Online Training
- Police & Fireboats
- Pipes, Pumps & Valves



E-Magazine Edition:

U.S. Offshore Wind: The Growth of an Industry

March 2022

Pushboats, Tugs & Barges

- Shipbuilding Report
- Coatings & Corrosion Control
- ECDIS, Radar & Navigation Equipment
- Fluid Handling Pumps and Filtration
- Spotlight: Q1 Inland Waterways Report

April 2022

Offshore Energy

- Vessel Repair & Conversion
- Rope & Cordage
- Marine Cranes
- Marine Electronics: Communication & Controls
- Heavy Lifters: Deck Machinery & Cranes

Event Distribution:

OTC: May 2-5, Houston, TX

IPF: April 26-28, Atlantic City, NJ

May 2022

Dredging

- Barges
- Material Handling Equipment
- Maritime Training & Education
- Spotlight Q2: Inland Waterways Report

Event Distribution:

Inland Marine Expo: May 23 - 25, St Louis, MO

June 2022

Combat & Patrol Craft

- Multi-mission Workboats
- Patrol Craft Propulsion : Inboard, Outboard and Water Jets
- Marine Lighting
- Workboat Communications

Event Distribution:

MACC: Jul 2022, National Arbor, MD
Seawork: June 21-23, Southampton, UK

July 2022

Propulsion Technology

- Autonomous Vessels
- Workboat Engines
- Water Treatment
- Fuels & Lubricants



E-Magazine Edition:

Inland Waterways: Operations, Expansion & Dredging

September 2022

Shipbuilding & Repair

- Naval Architecture/Marine Engineering
- Barge Loading & Unloading Equipment
- HVAC
- Spotlight: Q3 Inland Waterways Report

Event Distribution:

SMM: September 6-9 Hamburg, Germany

SNAME Expo: October

October 2022

MN100

- Offshore Wind
- U.S. Shipyards
- Inland Waterways
- Health & Safety

November 2022

Great Workboats of 2022

- TBest New Tech
- Power & Propulsion
- Deck Machinery
- Spotlight: Q4 Inland Waterways Report

Event Distribution:

Clean Gulf: December 2022
Workboat Show: December 2022



E-Magazine Edition:

Patrol, Escort & Fast Craft Operations

Post Your Resume for Free • Energize Your Job Search @ MaritimeJobs.com

MAXIMIZE YOUR POTENTIAL.



Find your new career at:
MaritimeJobs.com

www.MaritimeJobs.com

Marine Marketplace

VESSELS FOR SALE / BARGES FOR RENT

TUGS/BARGES FOR RENT
BARGES SIZED FROM 8'X18' TO
SECTIONAL BARGES
"TRUCKABLE TUGS" HERE

Smith Brothers Inc.,
Galesville, MD 20765
(410) 867-1818
www.smithbarge.com
Email us for more info:
keitha@mcleancontracting.com

Do your Advertising dollars
need a lifeline?



Best value and lowest cost per
thousand for your marketing budget.

www.marinelink.com



ZIDELL
MARINE
CORPORATION



Specializing In Barges

- Single or Double Hull, Inland or Ocean-Going
- Chartering & Sales

Ask for Bill Gobel

(503) 228-8691 • (800) 547-9259

2020 SW 4th Ave Suite 600

Portland, OR 97201

Join the industry's #1 LinkedIn group



**THE MARITIME
NETWORK**

<http://bit.do/MaritimeNetwork>

NEW PRODUCTS

LLEBROC
MARINE SEATING



Bandera2
HELM
CHAIR

CALL US TOLL FREE: 800-284-5771 or visit our website

WWW.LLEBROC.COM

**HYDRAULIC NOISE, SHOCK
AND VIBRATION SUPPRESSOR**

Noise, Shock, Vibration & Pulsation in
Quiet, Smooth Flow Out



QUALITY NACOL ACCUMULATORS

- Forged shells, no welds
- Long lasting, No Seam, Pleated Bladders
- We stock 1/5 pint to 15 gallons in Chicago
- Sizes available to 40 gallons



WILKES & MCLEAN, LTD.

877-534-6445
www.wilkesandmclean.com
info@wilkesandmclean.com

DOR-MOR®
Pyramid Mooring Anchors



SINCE 1988

Sizes 15 lbs. to the NEW 4,000 lbs.
Designed to dig into the bottom and achieve
holding power 10 times its weight at 3:1 scope
To hold boats, docks, nav. aids, nets, cables,
aquaculture pens. One lb. of Dor-Mor can
replace 10 lbs. of concrete.

Dor-Mor, Inc.

P. O. Box 461, Claremont, NH 03743

PHONE/FAX 603-542-7696

www.Dor-Mor.com

info@Dor-Mor.Com

Marine Marketplace

NEW PRODUCTS

Designed & Built for the Harsh Marine Environment

- EPOXY COATING PROVIDES ENHANCED CORROSION RESISTANCE
- MORE COPPER MEANS IT RUNS COOLER & USES LESS FUEL
- LOWEST COST OF OWNERSHIP

800.777.0714

Locate a dealer:
www.merequipment.com

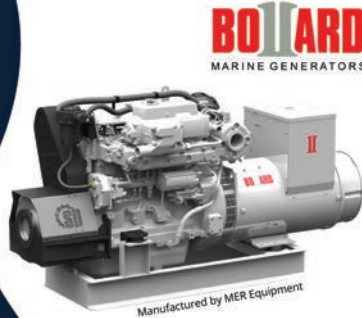

STAY COOL WITH KIENE'S TC-15 INDICATOR VALVE FOR EMD ENGINES!

- New indicator valve runs **COOL!**

TC-15 INDICATOR VALVE

- Easily meets
Subchapter M
requirement.

- Low temperature
and low profile
means improved
safety.



Don't cover your
indicator valves . . .

Switch to the **TC-15**
and stay cool!

Call or e-mail for info!

KIENE 1-800-264-5950
DIESEL ACCESSORIES, INC. info@kienediesel.com
www.kienediesel.com

M CHANGING THE WAY WE DELIVER NEWS

Get instant
updates- on
your phone
or tablet!



Maritime
Global News
For iPhone and Android

DOWNLOAD
THE
FREE APP



Apple, the Apple logo, iPhone, iPod touch, iPad and iTunes are trademarks of Apple Inc., registered in the U.S. and other countries. App Store is a service mark of Apple Inc. Android is a trademark of Google, Inc. © 2013 Maritime Activity Reports

PROFESSIONALS



Software for Naval Architects Stability | Strength | Seakeeping

GHS, the world-famous PC-based simulator of vessels in fluids and fluids in vessels- for ships, yachts, docks, drilling platforms, buoys, tanks, etc. - answering such questions as:

- * How deep and at what attitude will it float?
- * How much load will it carry?
- * When will it capsize?
- * Will it survive if damaged?

Also does: longitudinal strength - shear and bending moments, stress and deflection due to weight and buoyancy forces.

Includes ground reaction: buoyancy arising from points of ground contact.

*** New Dynamic Stability (DYNSTAB) module provides complete support for level 1 and level 2 IMO Second Generation Intact Stability guidelines.***



Creative Systems, Inc.

P.O. Box 1910 Port Townsend, WA 98368 USA
+1 (360) 385-6212 | sales@ghsport.com
www.GHSport.com

For 50 years, the software that naval architects love.

It's Time To Audit Your Media Buy.



Are you wasting
money on
publications
with unverifiable
circulation
numbers?

Insist on a **BPA** audit

Dry Docks Work Boats Barges

JMS-Designed
Modular Dry Dock
200' expandable to 420'
3,800 to 7,500t Lift Cap.



JMS
NAVAL ARCHITECTS

Let's make plans.

Naval Architecture
Marine Engineering
www.JMSnet.com
860.536.0009

ADVERTISER INDEX

Page	Company	Website	Phone#
19	Ahead Sanitation.....	www.aheadsanitationsystems.com.....	(337) 330-4407
29	All American Marine.....	www.AllAmericanMarine.com.....	(360) 647-7602
31	Clean Gulf.....	www.cleangulf.org.....	Visit us online
35	Environmental Marine, Inc.....	www.envmar.com.....	(606) 561-4697
19	Hillhouse Industrial Marine.....	www.hillhouseindustrialmarine.com.....	(603) 566-4330
8,9	Marine Systems, Inc.....	www.marinesystemsinc.com.....	(985) 223-7100
37	McDonough Marine Service.....	www.McdonoughMarine.com.....	(504) 780-8100
17	PYI Inc.....	www.pyiinc.com.....	(425) 355-3669
C4	R.W. Fernstrum & Company.....	www.fernstrum.com.....	(906) 863-5553
C3	Renewable Energy Group.....	www.regi.com/endura-fuels.....	Please visit our website
5	The American Equity Underwriters, Inc.....	www.amequity.com/safety-awards.....	Visit us online
7	Thordon Bearings.....	www.thordonbearings.com.....	Please visit our website
3	Volvo Penta Americas.....	www.volvopenta.us/challenge.....	(757) 403-8404
C2	ZF Marine Propulsion Systems Miramar, LLC.....	www.zfmarinepropulsion.com/go.....	1(833) ZFWRENCH

**The industry's leading news site.
Part of the world's largest maritime
publishing network.**

www.marinelink.com

*The listings above are an editorial service provided for the convenience of our readers.
If you are an advertiser and would like to update or modify any of the above information, please contact: nicole@marinelink.com*



Energy powers the world. Our clean fuels transform it.

InfiniD™

InfiniD™ is a simple, sustainable marine fuel solution.

Comply with recent sulfur cap regulations and lower carbon emissions — simply and easily. Part of our complete line of EnDura Fuels™, InfiniD™ is a sustainable biodiesel drop-in fuel that can improve marine engine performance and reduce carbon emissions for cleaner ports around the world. And it's all available — today.

Learn more about renewable marine fuel solutions.

[VISIT REGI.COM/ENDURA-FUELS](https://www.regi.com/endura-fuels)

We take the heat, so you don't have to.

Cool. Because you need it.

We deliver cool based on your reality. So no matter where you operate, hot days and heavy loads will never slow you down.



GRIDCOOLER® Keel Cooler

- **One Piece Head Design** maintains greater structural integrity.
- **Higher Silver Content Braze Joints** resist fatigue and maintain the strength of surrounding material.
- **Better Penetration at Braze Joints** places more braze material with less heat, making joints stronger.
- **2-Year Warranty on Copper Nickel GRIDCOOLER Keel Coolers:** Industry-leading design, craftsmanship and materials create industry-leading products.
- **70 Years of Experience with Fully Assembled Packaged Keel Coolers:** Our focus is and always has been heat exchangers.



WEKA Boxcooler®

- **Over 20 Years of Experience with Copper Nickel Boxcoolers** offering longer product life cycle than standard coated tube units.
- **Manufactured in the USA and The Netherlands:** provides the greatest product availability.
- **Weka Guard and Protector** eliminate the need for bulky and costly copper sacrificial anodes.

FERNSTRUM®
R.W. Fernstrum & Company

fernstrum.com | 1.906.863.5553 | sales@fernstrum.com | ISO 9001:2015